



Depuis sa création en 1978, Prevost propose une gamme de produits destinés aux installations de réseaux d'air comprimé et à la distribution des fluides. L'entreprise est présente dans les principaux secteurs de l'industrie et de l'automobile utilisant les énergies pneumatiques et hydrauliques.

L'innovation et la qualité ont toujours été deux axes essentiels dans le développement de l'entreprise, c'est pourquoi Prevost commercialise désormais de nombreux produits brevetés.

Grâce à son expérience acquise tout au long de ces années, Prevost développe aujourd'hui un large marché international et compte de nombreux clients en Europe, aux USA, et dans plus de 70 pays.



L'ÉNERGIE D'UNE ENTREPRISE, AU SERVICE DE SES DISTRIBUTEURS



Un service commercial disponible et réactif

Le service commercial PREVOST se compose de technico-commerciaux qualifiés dans le domaine des technologies fluides. Ils sont répartis sur l'ensemble du territoire et travaillent avec un réseau de professionnels qui assure la commercialisation de nos produits.

En interne, un pôle technique et commercial vous conseille lors des différentes étapes d'achat et répond à vos questions qu'elles soient d'ordre techniques, administratives ou commerciales.

Un service formation accueille régulièrement dans ses locaux, clients, commerciaux et assistant(e)s afin de garantir une parfaite connaissance des technologies et des produits commercialisés par Prevost.

Une logistique efficace

L'ensemble du process logistique est géré en temps réel grâce à des terminaux portables reliés par radio-fréquences au système de gestion central. Cela assure une constante maîtrise des stocks.











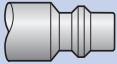
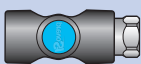
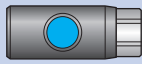
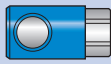
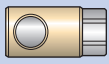

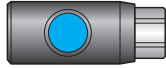
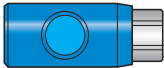
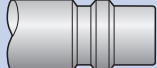

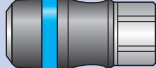
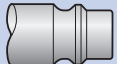
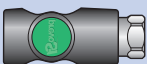

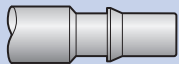

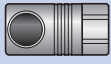
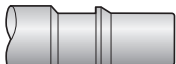



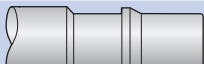
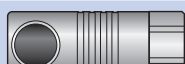

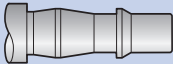
- ▶ Espace de stockage important
- ▶ WMS (Warehouse Management System) performant, éliminant le risque d'erreur de stock et d'expédition
- ▶ Expédition et suivi des colis, transmission directe par EDI

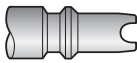
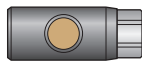
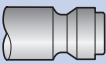
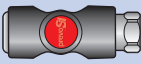
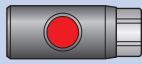
Un service marketing dynamique

Une équipe attentive aux évolutions du marché, qui adapte l'offre de l'entreprise aux attentes de ses clients.

- ▶ Création des supports commerciaux en plusieurs langues
- ▶ Organisation des salons professionnels nationaux et internationaux
- ▶ Création et maintenance du site internet www.prevost.eu
- ▶ Publicité online et print
- ▶ Développement des packagings et des supports de présentation produits

LES RACCORDS PREVOST

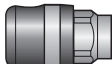
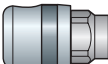
PROFILS	RACCORDS RAPIDES DE SÉCURITÉ			RACCORDS RAPIDES STANDARDS	
ISO 6150 SÉRIE B					
 IRP 06	 ISI 06	 ISC 06		 IRC 06	 IRM 06
 IRP 08	 ISI 08	 ISC 08		 IRC 08	
 IRP 11	 ISI 11	 ISG 11			
EUROPÉEN 7,2 - 7,4					
 ERP 07	 ESI 07 - ESI 07HE			 ERC 07	
	 ESI 11				
ISO 6150 SÉRIE C					
 CRP 06	 CSI 06	 CSC 06	 CSM 06		
 CRP 08	 CSI 08	 CSC 08	 CSM 08		
 CRP 11			 CSM 11		
ARO 210					
 ARP 06	 ASI 06				
BRITISH					
 BRP 06	 BSI 06				
ESPAGNOL					
 MRP 06		 MSC 06			
TRUFLATE					
 URP 06	 USI 06	 USC 06		 URC 06	
 URP 08	 USI 08	 USC 08		 URC 08	
	 USI 11				
ASIAN					
 ORP 08		 OSG 08		 ORG 08	

PROFILS DES RACCORNS PAR ZONES GÉOGRAPHIQUES

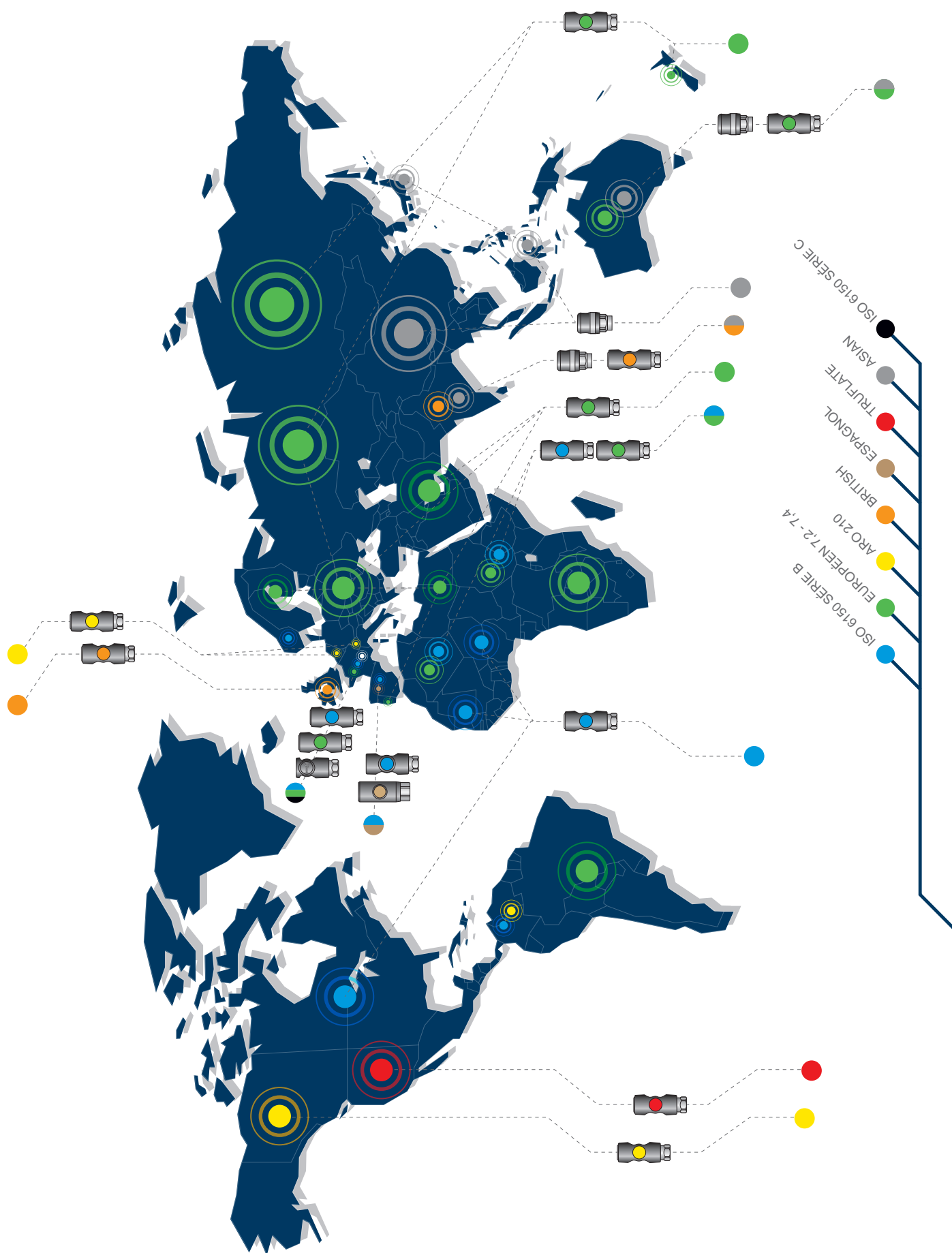



Raccords rapides de sécurité
PREVO S1 ISI 06
page : 14 - 15



Raccords rapides de sécurité
PREVO S1 ISI 08
page : 16 - 17

NOUVEAU



Raccords rapides de sécurité
PREVO S1 métal ISI 11
page : 18 - 19



Raccords rapides de sécurité
PREVO S1 ESI 07
page : 20 - 21

NOUVEAU



Raccords rapides de sécurité
PREVO S1 Inox ESI 07HE
page : 22 - 23

NOUVEAU



Raccords rapides de sécurité
PREVO S1 métal ESI 11
page : 24 - 25

NOUVEAU



Raccords rapides de sécurité
PREVO S1 CSI 06
page : 26 - 27

NOUVEAU



Raccords rapides de sécurité
PREVO S1 CSI 08
page : 28 - 29



Raccords rapides de sécurité
PREVO S1 ASI 06
page : 30 - 31



Raccords rapides de sécurité
PREVO S1 BSI 06
page : 32 - 33



Raccords rapides de sécurité
PREVO S1 USI 06
page : 34 - 35



Raccords rapides de sécurité
PREVO S1 USI 08
page : 36 - 37

NOUVEAU



Raccords rapides de sécurité
PREVO S1 métal USI 11
page : 38



Raccords rapides de sécurité
ISG 11
page : 41 - 42



Raccords rapides de sécurité
métalliques **CSM 06**
page : 45 - 46



Raccords rapides de sécurité
métalliques **CSM 08**
page : 47 - 48



Raccords rapides de sécurité
métalliques **CSM 11**
page : 49 - 50



Raccords rapides standards
PROLAC IRC 06
page : 53 - 54



Raccords rapides standards
PROLAC IRC 08
page : 55 - 56



Raccords rapides standards
métalliques **IRM 06**
page : 57 - 58



Raccords rapides INOX
PROXI 06
page : 59



Protecteurs, lubrificateurs de ligne
NSB - LUB'AIR
page : 61



Raccords air respirable
BAC 07
page : 64



Raccords instantanés polymère
CONEX
page : 67 - 103



Raccords instantanés métalliques
CONEX
page : 104 - 108



Raccords instantanés INOX
CONEX
page : 109



Accessoires de lignes
Silencieux **PROXI 06**
page : 110 - 111



Raccords à compression et à olive
RB - RO
page : 113 - 116



Raccords rapides pour circuits de refroidissement
CPI
page : 118 - 121



Raccords rapides pour fluides
PREOL
page : 123 - 124



Raccords automatiques eau
ELS 09
page : 127 - 129



Raccords soudeure
ISOFLAM
page : 132 - 135



Raccords hydrauliques
page : 137 - 143



Pièces de raccordement (connecteurs)
page : 146 - 161



Produits d'étanchéité
page : 160



Vannes
page : 165 - 167



Raccords Express
EXP
page : 168

distribution

s o m m a i r e



Tubes et raccords pour réseaux
 Concept ALR
 page : 177 - 187



Applique murales
 Prevo S1
 page : 181 - 182



Flexibles de liaison
 page : 188



Tubes et raccords pour réseaux
 Concept PVR
 page : 194 - 205



Soupapes
 page : 209



Enrouleurs air, eau, graisse, huile, soudure
 page : 214 - 225



Enrouleurs électricité
 page : 226



Tubes polyuréthane et polyamide
 page : 238 - 241



Tuyaux souples en couronne
 page : 242 - 244



Rallonges de tuyau équipées de raccords
 page : 247 - 250



Tuyaux spirales
 page : 253 - 258



Colliers de serrage à oreilles et à vis
 page : 260 - 269



Soufflettes et autres soufflettes
 27102
 page : 272 - 277

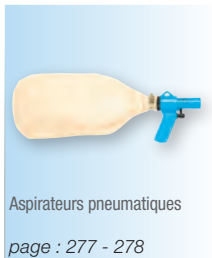

Aspirateurs pneumatiques
 page : 277 - 278



Ensembles de soufflage
 page : 279 - 281



Pistolets de gonflage
 page : 282



Pistolets de lavage et de pulvérisation
 page : 285 - 286



Pistolets de peinture
 page : 289 - 294



Modules de séchage peinture
 page : 295



Outils pneumatiques
 page : 299 - 311



Equilibrés à câble
 Bras de suspension
 BAL
 page : 314 - 316



Boîtier multiénergies
 page : 316



Pompes pneumatiques graisse et huile
 page : 319 - 322



Récupérateurs d'huile
 page : 323

traitement

s o m m a i r e

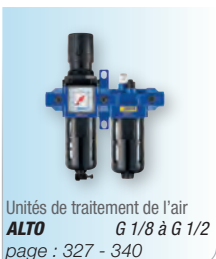

Unités de traitement de l'air
 ALTO G 1/8 à G 1/2
 page : 327 - 340



Unités de traitement de l'air
 ALTO 4 G 3/4, G 1
 page : 343 - 344



Unités de traitement de l'air
 ALTO MAX G 1 1/4 à 2 1/2
 page : 345



Ensemble de traitement sur portique
 page : 346



Manomètres
 page : 347 - 349

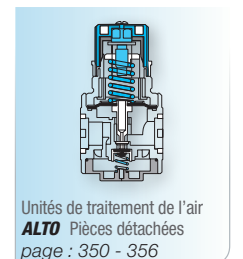

Unités de traitement de l'air
 ALTO Pièces détachées
 page : 350 - 356



Filtration submicronique
 MICRO AIR
 page : 363 - 366



Cartouches de rechange pour filtres submicroniques
 page : 367 - 373



Purges électriques et mécaniques
 page : 376 - 380



Unités de traitement des condensats
 page : 380 - 381



Sécheurs par réfrigération
 ALTITUDE
 page : 384 - 386



Sécheurs par adsorption
 ALASKA
 page : 389 - 390

prevo S1

RACCORDS RAPIDES DE SÉCURITÉ

L'EXPERTISE AU SERVICE DE LA SÉCURITÉ ET DES PERFORMANCES

Le raccord **PREVO S1** représente la **dernière génération des procédés de connexion pneumatique**. Un outil qui répond, en totale sécurité, aux besoins les plus exigeants de l'opérateur : **étanchéité, débit, rapidité de connexion et déconnexion**.

Le raccord de sécurité s'installe au niveau de la source d'air, où l'on va connecter les flexibles qui peuvent générer le coup de fouet lors de la déconnexion.



PERFORMANCE

Raccord rapide à bouton

D'un seul geste, le bouton permet de décompresser et de déconnecter les systèmes et outils pneumatiques. La couleur du bouton permet d'identifier le profil de connexion.

Débit optimal

Permet un rendement maximum des outils pneumatiques.

Étanchéité parfaite

Une excellente tenue de l'embout dans le raccord (soupape profilée, joint nitrile) assure une étanchéité optimale.

Fabrication sans silicone

Évite les risques de contamination de l'air comprimé lors d'opérations telles que l'application de peintures ou de vernis. Aucun silicone n'intervient durant le process de fabrication et de montage.

Anti-rayure

Le corps en composite prévient de tout accident pouvant endommager les surfaces fragiles (carrosserie, meubles, matériel informatique...).

Corps antistatique

Assure la conductibilité électrique et évite tous les risques liés au phénomène d'électricité statique.

Design ergonomique

Le design du Prevo S1 permet une préhension parfaite et intuitive du raccord et offre à l'opérateur une excellente prise en main et une manipulation facile.

Léger et compact

Les dimensions et les volumes réduits des **Prevo S1** assurent à l'utilisateur un travail précis et sans fatigue.

Robuste

Le corps en matériau composite aux caractéristiques mécaniques renforcées résiste à l'abrasion, aux chocs, à l'écrasement, aux vibrations et à la corrosion.

Connexion sans effort

Permet un changement d'outil rapide et un confort d'utilisation.

Corps orientable

La possibilité de tourner le corps du raccord permet de rendre le bouton accessible dans toutes les configurations.

Compatibilité internationale

La gamme **Prevo S1** couvre l'ensemble des profils (ISO B, ISO C, 7.2 mm...). Elle répond aux impératifs de la majorité des standards internationaux.

SÉCURITÉ

Sécurité totalement intégrée

Le mécanisme de décompression garantit un désaccouplement sans aucun risque d'accident lors de l'éjection de l'embout.

À la déconnexion, un seul appui sur le bouton assure la décompression immédiate de l'air comprimé en aval de la canalisation et le désaccouplement de l'embout. Raccord en conformité avec la norme **ISO 4414** garantissant la protection de l'utilisateur.

Classement ATEX 94/9/CE

La certification **ATEX 2** confirme la sécurité de l'utilisation du **Prevo S1** dans la majorité des industries (environnements gazeux, transferts de céréales, cabines de peinture...). Les raccords **Prevo S1** doivent être considérés comme des composants destinés à être incorporés dans des équipements. Ils ne possèdent pas de propre source potentielle d'inflammation. Ils peuvent être utilisés dans un équipement construit pour répondre au classement suivant :

- Groupe II
- Catégorie 2
- Groupe d'ATEX GD
- Nature d'ATEX IIB

Applications

Que ce soit en implantation (alimentation de flexibles ou distribution d'air comprimé sur poste fixe) ou en branchement direct (outillage, soufflettes, pistolets), les fonctions du **Prevo S1** s'utilisent sur l'ensemble de l'installation. Le choix du diamètre de passage à l'intérieur du raccord est fonction de la quantité d'air nécessaire à l'application.



LA QUALITÉ ET L'EXPERTISE AU CŒUR DE LA CONCEPTION



GAMME **prevoS1**

► **Construction:**

- Corps : matériau composite
- Autres composants : acier traité anticorrosion ou aluminium conforme RoHS*
- Étanchéité du filetage par joint nitrile NBR

► **Pression et températures :**

- Plage de pression de service : 2 à 12 bar (ne convient pas au vide)
- Température : de -15°C à +70°C

► **Ultra-léger**

- 74 g pour les raccords en passage 6 mm (sortie tuyau)
- 113 g pour les raccords en passage 8 mm (sortie tuyau)

► **Antistatique**

Les raccords **PrevoS1** assurent la conductibilité électrique

► **Souplesse d'accouplement :**

- < 80 N sous 6 bar pour les raccords passage 6 mm
 - < 100 N sous 6 bar pour les raccords passage 7.2 et 8 mm
- (Unité de mesure N = Newton)

► **Normes de construction**

- Les raccords **PrevoS1** répondent :
- à la directive européenne DESP 97/23/CE
 - aux exigences de sécurité de la norme ISO 4414
 - à la directive européenne RoHS 2002/95/CE*

**Directive RoHS 2002/95/CE : relative à la limitation de l'utilisation de certaines substances dangereuses dans les équipements électriques, (plomb, mercure, cadmium, chrome hexavalent, polybromobiphényles -PBB- et polybromodiphényléthers -PBDE-).*

Débit sous 6 bar pour un ΔP de 0,6 bar

PROFILS	ISO B Passage 6 mm	ISO C Passage 6 mm	ARO Passage 6 mm	British Passage 6 mm	Truflate Passage 6 mm	Européen Passage 7,2 mm	ISO B Passage 8 mm	ISO B Passage 8 mm	Truflate Passage 8 mm
RÉFÉRENCES	ISI 06	CSI 06	ASI 06	BSI 06	USI 06	ESI 07	ISI 08	CSI 08	USI 08
Débit l/mn	833	833	800	750	833	1820	2028	2028	2028

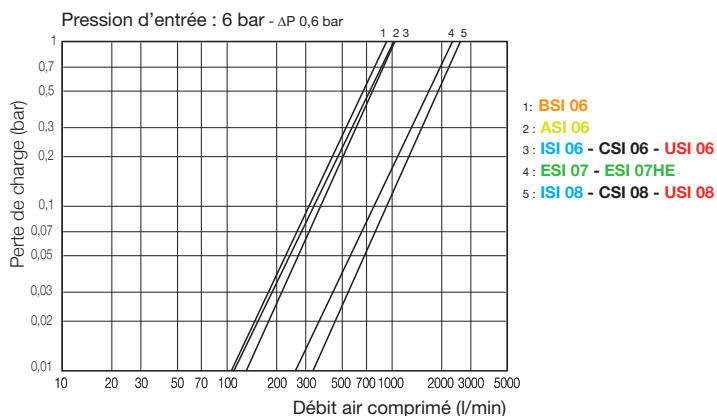



GAMME prevoS1 MÉTAL PASSAGE 11 MM

► Construction:

- Corps : acier inox à 17% de chrome
- Etanchéité du filetage par joint nitrile NBR
- Clapet et bouton : matériau composite
- Verrouillage : acier traité anticorrosion
- Autres composants : acier traité anticorrosion conforme RoHS ou aluminium

► Pression et températures :

- Plage de pression de service : 2 à 16 bar (ne convient pas au vide)
- Température : de -15°C à +70°C

► Effort d'accouplement sous 6 bar :

< 160 N sous 6 bar
(Unité de mesure N = Newton)

► Normes de construction









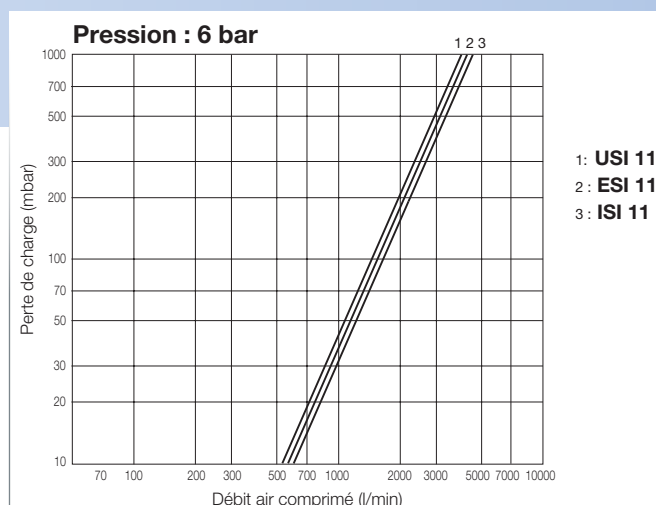

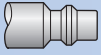
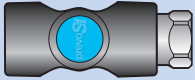
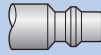
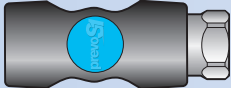
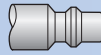







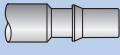

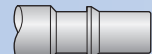

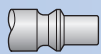
Les raccords **PrevoS1** répondent :

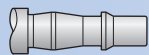
- à la directive européenne DESP 97/23/CE
- aux exigences de sécurité de la norme ISO 4414
- à la directive européenne RoHS 2002/95/CE

Débit sous 6 bar pour un ΔP de 0,6 bar

PROFILS	ISO B Passage 11 mm	Européen Passage 10,4 mm	Truflate Passage 10 mm
RÉFÉRENCES	ISI 11	ESI 11	USI 11
Débit l/min	3686	3530	2987

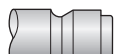

PROFILS	RÉF.	RACCORDS RAPIDES DE SÉCURITÉ	PASSAGE	FILETAGE	DÉBITS à 6 bar pour Δp 0,6 bar
Profil ISO 6150 B US mil 4109 	ISI 06		6 mm	BSP/NPT	833 l/min
Profil ISO 6150 B US mil 4109 	ISI 08		8 mm	BSP/NPT	2028 l/min
Profil ISO 6150 B US mil 4109 	ISI 11		11 mm	BSP / NPT	3686 l/min
Profil Européen 7.2 - 7.4 mm 	ESI 07		7,2 mm	BSP/NPT	1820 l/min
Profil Européen 7.2 - 7.4 mm (version inox) 	ESI 07HE		7,2 mm	BSP	1820 l/min
Profil Européen 10,4 	ESI 11		10,4 mm	BSP / NPT	3530 l/min
Profil ISO 6150 C 	CSI 06		6 mm	BSP	833 l/min
Profil ISO 6150 C 	CSI 08		8 mm	BSP	2028 l/min
Profil ARO 210 	ASI 06		6 mm	BSP/NPT	800 l/min
Profil British 	BSI 06		6 mm	BSP	750 l/min
Profil Truflate 	USI 06		6 mm	NPT	833 l/min
Profil Truflate 	USI 08		8 mm	NPT	2028 l/min
Profil Truflate 	USI 11		10 mm	NPT	2987 l/min

TYPES D'IMPLANTATION



► Taraudage cylindrique

- Gaz BSP
- Norme internationale ISO 228/1



► Filetage mâle cylindrique

- Gaz BSP
- Joint d'étanchéité intégré
- Norme internationale ISO 228/1



► Filetage mâle conique

- Gaz NPT
- Norme américaine de filetage ANSI/ASME B 1.20.1 (marché nord américain)

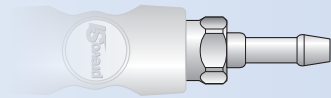

► Raccordement pour tuyau

- Montage avec collier à vis ou à oreille



► Traversée de cloison

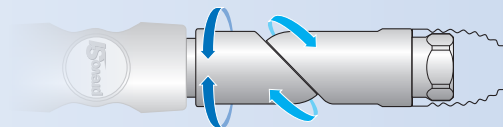

► Liaison orientable taraudée

- Rotation sur 2 axes à 360°
- Protection antirayures

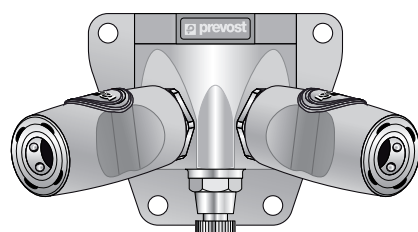

► Applique murale

LA QUALITÉ DES EMBOUTS PREVOST

- **Matériau** : Acier, résistant aux rayures et à la corrosion. Les embouts **Prevost** répondent à la directive européenne RoHS 2002/95/CE
- **Interchangeabilité** : Compatibilité avec tous les standards en vigueur et profils internationaux : dimensions, tolérances des cotes, dureté et protection contre la corrosion.

Un usinage de qualité confère à l'embout **Prevost** une parfaite adaptabilité à son raccord et fait du couple raccord/embout, un système de transmission pneumatique sûr et pérenne dans toutes les utilisations, y compris les plus sévères.

IDENTIFICATION DES RACCORDS

- Code couleur en fonction des profils internationaux
- Logique de composition des références
- Gravure des filetages sur le produit

I	S	I	06	1	1	01	SW
			06 : Ø 6 mm 07 : Ø 7,2 mm 08 : Ø 8 mm 11 : Ø 11 mm				Option
		I = prevost P = Embout		1 = Raccord 2 = Traversée 6 = Embout 8 = Y			SW = liaison orientable WF = applique murale HE = version inox
	S = Sécurité			1 = BSP 2 = NPT 8 = Queue tuyau			
A = Aro B = British C = ISO C E = 7,2 / 11 I = ISO B U = Trufilate				101 = 1/4 femelle 102 = 3/8 femelle 103 = 1/2 femelle 104 = 3/4 femelle 151 = 1/4 mâle 152 = 3/8 mâle 153 = 1/2 mâle 154 = 3/4 mâle		806 = Ø flexible 6 mm 808 = Ø flexible 8 mm 810 = Ø flexible 10 mm 813 = Ø flexible 13 mm 816 = Ø flexible 16 mm 819 = Ø flexible 19 mm	

RACCORDS RAPIDES SECURITE PREVO S1 - ISI 06



Sécurité anti coup de fouet	Température - 15°C + 70°C	Matière Composite	Utilisation Applications pneumatiques	Passage 6 mm	Pression P.N. 12 bar	Couleur Noir / Bleu	Débit sous 6 bar 833 l/min - DP = 0,6 b	Poids 74 g (raccord pour tuyau Ø 8 mm)
-----------------------------	---------------------------	-------------------	---------------------------------------	--------------	----------------------	---------------------	---	--

		A	B	C	D	E	DESIGNATION	REFERENCE
Raccord taraudé femelle cylindrique								
		68.6	30	20			G 1/4	ISI 061101
		74	30	20			G 3/8	ISI 061102
		80.1	30	26			G 1/2	ISI 061103
Raccord fileté mâle cylindrique avec joint d'étanchéité								
		76.3	30	20			G 1/4	ISI 061151
		78.3	30	23			G 3/8	ISI 061152
		82.3	30	26			G 1/2	ISI 061153
Raccord pour flexibles								
		83	30	19.4			Ø 6 mm	ISI 061806
		83	30	19.4			Ø 8 mm	ISI 061808
		83	30	19.4			Ø 10 mm	ISI 061810
		88	30	19.4			Ø 13 mm	ISI 061813
Raccord orientable taraudé femelle								
							Liaison orientable Rotation sur 2 axes à 360°	
		172	30	125.3			G 3/8	ISI 061102SW
Distributeur fixe à 2 directions taraudé femelle								
		134	82	17			G 1/4	ISI 068101
		140	87	20			G 3/8	ISI 068102
		150	95	25			G 1/2	ISI 068103
Distributeur fixe à 2 directions fileté mâle cylindrique								
		134	88	17			G 1/4	ISI 068151
		140	92	20			G 3/8	ISI 068152
		150	104	25			G 1/2	ISI 068153

RACCORDS RAPIDES SECURITE PREVO S1 - ISI 06



Sécurité anti coup de fouet	Température -15°C + 70°C	Matière Composite	Utilisation Applications pneumatiques	Passage 6 mm	Pression P.N. 12 bar	Couleur Noir / Bleu	Débit sous 6 bar 833 l/min - DP = 0,6 b	Poids 74 g (raccord pour tuyau Ø 8 mm)
-----------------------------	--------------------------	-------------------	---------------------------------------	--------------	----------------------	---------------------	---	--

		A	B	C	D	E	DESIGNATION	REFERENCE	
Raccord taraudé femelle pour traversée de cloison									
		84	30	29	32		Taraudé femelle G 1/4 Ø de perçage sur platine en mm : 27 mm Epaisseur de la platine en mm : 2 à 11 mm maxi	ISI 062101	
Applique murale taraudée - 2 raccords et purge manuelle - Profil ISO B - Passage 6 mm									
		71	57	38	70	6,5	Entrée taraudée G 1/2	Sortie : 2 raccords 2 raccords ISI 06	ISI 068103WF
		71	57	38	70	6,5	G 3/4	2 raccords ISI 06	ISI 068104WF

EMBOUTS POUR RACCORDS RAPIDES - IRP 06

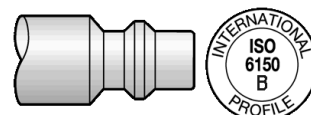

Passage 6 mm	Pression P.N. 16 bar	Précision Respect des tolérances	Matière Acier traité Revêtement anti-corrosion	Durété Résistance à l'abrasion
--------------	----------------------	----------------------------------	--	--------------------------------

		A	B	C	D	DESIGNATION	REFERENCE
Embout taraudé femelle							
		40.5	15			G 1/4	IRP 066101
		43	14			G 1/4 avec cône d'étanchéité	IRP 066101AE
		45	21			G 3/8	IRP 066102
		34	14			Pas Michelin (pas 0,8). Convient au pistolet de gonflage	IRP 066310
		44	17			Devilbiss (pas 9/16" - 20 filets au pouce)	IRP 066315
		41	17			1/4 NPS M	IRP 066301
		43	14			14/125 avec cône d'étanchéité	IRP 066314
Embout fileté mâle conique							
		39.5	13			Filetage préteflonné	
						R 1/4 - préteflonné	IRP 066151
						R 3/8 - préteflonné	IRP 066152
						14/125 - cylindrique	IRP 066354
Embout pour flexibles							
		49				Ø 6 - 7 mm	IRP 066806
		50				Ø 8 mm	IRP 066808
		50				Ø 9 - 10 mm	IRP 066810
		85				Ø 13 mm	IRP 066813
Embout à coiffe pour flexibles							
		76	17	17	19	Ø 6 x 12 mm - Ø 6 x 11 mm	IRP 066806CO
		79	17	22	24	Ø 8 x 14 mm - Ø 8 x 13 mm	IRP 066808CO
		79	17	22	24	Ø 9 x 15 mm - Ø 9 x 14 mm	IRP 066809CO
		79	17	22	24	Ø 10 x 16 mm - Ø 10 x 15 mm	IRP 066810CO

RACCORDS RAPIDES SECURITE PREVO S1 - ISI 08

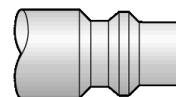

Sécurité anti coup de fouet	Température - 15°C + 70°C	Matière Composite	Utilisation Applications pneumatiques	Passage 8 mm	Pression P.N. 12 bar	Couleur Noir / Bleu	Débit sous 6 bar 2 028 l/min - DP = 0,6 b	Poids 113 g (raccord pour tuyau Ø 13 mm)
-----------------------------	---------------------------	-------------------	---------------------------------------	--------------	----------------------	---------------------	---	--

		A	B	C	D	E	DESIGNATION	REFERENCE	
Raccord taraudé femelle cylindrique									
		82.4	33	23			G 1/4	ISI 081101	
		82.4	33	23				G 3/8	ISI 081102
		89.4	33	26				G 1/2	ISI 081103
Raccord fileté mâle cylindrique avec joint d'étanchéité									
		90.4	33	23			G 1/4	ISI 081151	
		91.4	33	23				G 3/8	ISI 081152
		93.4	33	26				G 1/2	ISI 081153
Raccord pour flexibles									
		96.4	33	22.6			Ø 8 mm	ISI 081808	
		96.4	33	22.6				Ø 10 mm	ISI 081810
		101.4	33	22.6				Ø 13 mm	ISI 081813
		101.4	33	22.6				Ø 16 mm	ISI 081816
Raccord orientable taraudé femelle									
							Liaison orientable Rotation sur 2 axes à 360°		
		184	33	137.7				G 3/8	ISI 081102SW
Distributeur fixe à 2 directions taraudé femelle									
		160	98	20			G 3/8	ISI 088102	
		167	103	25				G 1/2	ISI 088103
		180	124	25				G 3/4	ISI 088104
Distributeur fixe à 2 directions fileté mâle cylindrique									
		160	103	20			G 3/8	ISI 088152	
		167	112	25				G 1/2	ISI 088153
		180	145	32				G 3/4	ISI 088154

RACCORDS RAPIDES SECURITE PREVO S1 - ISI 08



Sécurité anti coup de fouet	Température - 15°C + 70°C	Matière Composite	Utilisation Applications pneumatiques	Passage 8 mm	Pression P.N. 12 bar	Couleur Noir / Bleu	Débit sous 6 bar 2 028 l/min - DP = 0,6 b	Poids 113 g (raccord pour tuyau Ø 13 mm)
-----------------------------	---------------------------	-------------------	---------------------------------------	--------------	----------------------	---------------------	---	--

		A	B	C	D	E	DESIGNATION	REFERENCE	
Raccord taraudé femelle pour traversée de cloison									
		96,9	33	29	32		G 1/2 Ø perçage sur platine en mm : 27 Epaisseur de la platine en mm : 2 à 11 mm maxi	ISI 082103	
Applique murale taraudée - 2 raccords et purge manuelle - Profil ISO B - Passage 8 mm									
		71	57	38	70	6,5	Entrée taraudée G 1/2	Sortie : 2 raccords 2 raccords ISI 08	ISI 088103WF
		71	57	38	70	6,5	G 3/4	2 raccords ISI 08	ISI 088104WF

EMBOUTS POUR RACCORDS RAPIDES - IRP 08

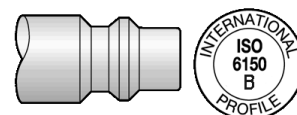

Durété Résistance à l'abrasion	Passage 8 mm	Précision Respect des tolérances	Pression 16 bar	Matière Acier traité Revêtement anticorrosion
-----------------------------------	--------------	-------------------------------------	-----------------	---

		A	B	DESIGNATION	REFERENCE
Embout taraudé femelle					
		45	17	G 1/4	IRP 086101
		49	21	G 3/8	IRP 086102
		53	28	G 1/2	IRP 086103
Embout fileté mâle conique					
		44.5	17	Filetage prétéflonné	
		44.5	17	R 1/4 - prétéflonné	IRP 086151
		55	22	R 3/8 - prétéflonné	IRP 086152
Embout pour flexibles					
		62		Ø 8 mm	IRP 086808
		53.5		Ø 9 - 10 mm	IRP 086810
		59		Ø 13 mm	IRP 086813
		60		Ø 16 mm	IRP 086816

RACCORDS RAPIDES SECURITE PREVO S1 METAL - ISI 11





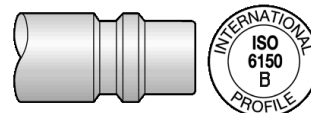

Sécurité anti coup de fouet	Température - 15°C + 70°C	Matière Corps Inox	Utilisation Applications pneumatiques	Passage 11 mm	Pression P.N. 16 bar	Couleur Inox/Bouton Bleu	Débit sous 6 bar 3 686 l/min - DP = 0,6 b
-----------------------------	---------------------------	--------------------	---------------------------------------	---------------	----------------------	--------------------------	---

		A	B	C	DESIGNATION	REFERENCE
Raccord taraudé femelle cylindrique						
		101	37	26	G 3/8	ISI 111102
		102	37	26	G 1/2	ISI 111103
		110,5	37	30	G 3/4	ISI 111104
Raccord fileté mâle cylindrique avec joint d'étanchéité						
		108,9	37	26	G 3/8	ISI 111152
		109,9	37	26	G 1/2	ISI 111153
		114,4	37	32	G 3/4	ISI 111154
Raccord pour flexibles						
		136	37	10	Ø 10 mm	ISI 111810
		120	37	12,5	Ø 13 mm	ISI 111813
		120	37	15,5	Ø 16 mm	ISI 111816
		161	37	18,5	Ø 19 mm	ISI 111819
Raccord orientable taraudé femelle						
		183	37	27	G 1/2	ISI 111103SW

EMBOUS POUR RACCORDS RAPIDES - IRP 11

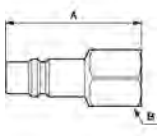

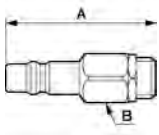
Dureté Résistance à l'abrasion Dureté : 650 Hv	Passage 11 mm	Précision Respect des tolérances	Pression 16 bar	Matière Acier traité - Revêtement anticorrosion
--	------------------	-------------------------------------	--------------------	--

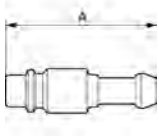
		A	B	DESIGNATION	REFERENCE
Embout taraudé femelle					
		60	25	G 3/8	IRP 116102
		60	25	G 1/2	IRP 116103
Embout fileté mâle conique					
				Filetage préteflonné	
		82	25	R 3/8 - préteflonné	IRP 116152
		84	25	R 1/2 - préteflonné	IRP 116153
Embout pour flexibles					
		65		Ø 9 - 10 mm	IRP 116810
		70		Ø 13 mm	IRP 116813
		69		Ø 16 mm	IRP 116816
		92		Ø 19 mm	IRP 116819

RACCORDS RAPIDES SECURITE PREVO S1 - ESI 07



Sécurité anti coup de fouet	Température -15°C + 70°C	Matière Composite	Utilisation Applications pneumatiques	Passage 7,2 - 7,4 mm	Pression P.N. 12 bar	Couleur Noir / Vert	Débit sous 6 bar 1 820 l/min - DP = 0,6 b	Poids 86 g (raccord pour tuyau Ø 13 mm)
-----------------------------	--------------------------	-------------------	---------------------------------------	----------------------	----------------------	---------------------	---	---

		A	B	C	D	E	DESIGNATION	REFERENCE
Raccord taraudé femelle cylindrique								
		73.3	32.25	23			G 1/4	ESI 071101
		73.3	32.25	23			G 3/8	ESI 071102
		80.3	32.25	26			G 1/2	ESI 071103
Raccord fileté mâle cylindrique avec joint d'étanchéité								
		81.3	32.25	23			G 1/4	ESI 071151
		82.3	32.25	23			G 3/8	ESI 071152
		84.3	32.25	26			G 1/2	ESI 071153
Raccord pour flexibles								
		87.3	32.25	22,6			Ø 6 mm	ESI 071806
		87.3	32.25	22,6			Ø 8 mm	ESI 071808
		87.3	32.25	22,6			Ø 9 mm	ESI 071809
		87.3	32.25	22,6			Ø 10 mm	ESI 071810
		92.3	32,25	22,6			Ø 13 mm	ESI 071813
Raccord orientable taraudé femelle								
							Liaison orientable Rotation sur 2 axes à 360°	
		176.3	32.25	128,6			G 3/8	ESI 071102SW
Distributeur fixe à 2 directions taraudé femelle								
		150	97	23			G 3/8	ESI 078102
		160	111	26			G 1/2	ESI 078103
Distributeur fixe à 2 directions fileté mâle cylindrique								
		145	95	23			G 3/8	ESI 078152
		155	108	26			G 1/2	ESI 078153

RACCORDS RAPIDES SECURITE PREVO S1 - ESI 07



Sécurité anti coup de fouet	Température -15°C + 70°C	Matière Composite	Utilisation Applications pneumatiques	Passage 7,2 - 7,4 mm	Pression P.N. 12 bar	Couleur Noir / Vert	Débit sous 6 bar 1 820 l/min - DP = 0,6 b	Poids 86 g (raccord pour tuyau Ø 13 mm)
-----------------------------	--------------------------	-------------------	---------------------------------------	----------------------	----------------------	---------------------	---	---

		A	B	C	D	E	DESIGNATION	REFERENCE	
Raccord taraudé femelle pour traversée de cloison									
		87.8	32.25	29	32		G 1/2 Ø de perçage : 27 mm Epaisseur de la cloison : 2 à 11 mm maxi	ESI 072103	
Applique murale taraudée - 2 raccords et purge manuelle - Profil Européen 7.2 mm									
		71	57	38	70	6,5	Entrée taraudée G 1/2	Sortie : 2 raccords 2 raccords ESI 07	ESI 078103WF
		71	57	38	70	6,5	G 3/4	2 raccords ESI 07	ESI 078104WF

EMBOUTS POUR RACCORDS RAPIDES - ERP 07

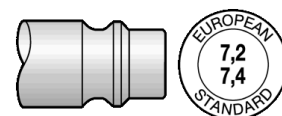

Passage 7,2 - 7,4 mm	Pression P.N. 16 bar	Précision Respect des tolérances	Durété Résistance à l'abrasion	Matière Acier traité
----------------------	----------------------	----------------------------------	--------------------------------	----------------------

		A	B	DESIGNATION	REFERENCE
Embout taraudé femelle					
		40	15	G 1/4	ERP 076101
		41	21	G 3/8	ERP 076102
		44	27	G 1/2	ERP 076103
Embout fileté mâle conique					
		35.5	13	Filetage prééflonné R 1/4 - prééflonné	ERP 076151
		41	17	R 3/8 - prééflonné	ERP 076152
		52	24	R 1/2 - prééflonné	ERP 076153
Embout pour flexibles					
		44.5		Ø 6 mm	ERP 076806
		46		Ø 8 mm	ERP 076808
		54		Ø 9 mm	ERP 076809
		46		Ø 10 mm	ERP 076810
		51.5		Ø 13 mm	ERP 076813

RACCORDS RAPIDES SECURITE

PREVO S1 - INOX

ESI 07HE



Sécurité anti coup de fouet	Température -15°C + 70°C	Matière Corps composite Obturateur et douille inox 316 L	Utilisation Ambiances humides - corrosives	Passage 7,2 - 7,4 mm	Pression P.N. 12 bar	Couleur Noir / Vert	Débit sous 6 bar 1 820 l/min - DP = 0,6 b
-----------------------------	--------------------------	--	--	----------------------	----------------------	---------------------	---

		A	B	C	DESIGNATION	REFERENCE
Raccord taraudé femelle cylindrique						
		73.3	32.2	23	G 1/4	ESI 071101HE
		73.3	32.2	26	G 3/8	ESI 071102HE
		80.3	32.2	26	G 1/2	ESI 071103HE
Raccord fileté mâle cylindrique avec joint d'étanchéité						
		81.3	32.2	23	G 1/4	ESI 071151HE
		82.3	32.2	26	G 3/8	ESI 071152HE
		84.3	32.2	26	G 1/2	ESI 071153HE
Raccord pour flexibles						
		87.3	32.2	23	Ø 8 mm	ESI 071808HE
		87.3	32.2	23	Ø 9 mm	ESI 071809HE
		87.3	32.2	23	Ø 10 mm	ESI 071810HE

EMBOUS INOX POUR RACCORDS RAPIDES ERP 07 HE

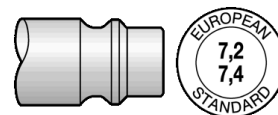

Passage 7,2 - 7,4 mm	Pression P.N. 16 bar	Précision Respect des tolérances	Dureté Résistance à l'abrasion	Matière INOX 316L	Utilisation Ambiances corrosives Environnements humides
-------------------------	-------------------------	-------------------------------------	-----------------------------------	----------------------	---

		A	B	DESIGNATION	REFERENCE
Embout taraudé femelle					
		40	15	G 1/4	ERP 076101HE
		41	21	G 3/8	ERP 076102HE
Embout fileté mâle conique					
		35.5	13	R 1/4 - prétefflonné	ERP 076151HE
		41	17	R 3/8 - prétefflonné	ERP 076152HE
Embout pour flexibles					
		46		Ø 8 mm	ERP 076808HE
		54		Ø 9 mm	ERP 076809HE
		46		Ø 10 mm	ERP 076810HE

RACCORDS RAPIDES SECURITE PREVO S1 METAL - ESI 11







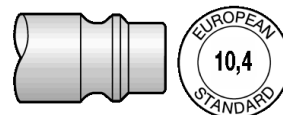

Sécurité anti coup de fouet	Température - 15°C + 70°C	Matière Corps Inox	Passage 10,4 mm	Pression P.N. 16 bar	Couleur Metal / Bouton vert	Débit sous 6 bar 3 530 l/min - DP = 0,6 b
-----------------------------	---------------------------	--------------------	-----------------	----------------------	-----------------------------	---

		A	B	C	DESIGNATION	REFERENCE
Raccord taraudé femelle cylindrique						
		92,5	37	26	G 3/8	ESI 111102
		93,5	37	26	G 1/2	ESI 111103
		102	37	30	G 3/4	ESI 111104
Raccord fileté mâle cylindrique avec joint d'étanchéité						
		100,4	37	26	G 3/8	ESI 111152
		101,4	37	26	G 1/2	ESI 111153
		105,9	37	32	G 3/4	ESI 111154
Raccord pour flexibles						
					Ø 9 mm	ESI 111809
		127,5	37	10	Ø 10 mm	ESI 111810
		111,4	37	12,5	Ø 13 mm	ESI 111813
		111,4	37	15,5	Ø 16 mm	ESI 111816
		152,5	37	18,5	Ø 19 mm	ESI 111819
Raccord orientable taraudé femelle						
		174	37	27	G 1/2	ESI 111103SW

EMBOUITS POUR RACCORDS RAPIDES - ERP 11



Dureté Résistance à l'abrasion Dureté : 650 Hv	Passage 10,4 mm	Précision Respect des tolérances	Pression 16 bar	Matière Acier traité - Revêtement anticorrosion
--	--------------------	-------------------------------------	--------------------	---

		DESIGNATION	REFERENCE
Embout taraudé femelle			
		G 3/8	ERP 116102
		G 1/2	ERP 116103
		G 3/4	ERP 116104
Embout fileté mâle			
		R 3/8 - préteflonné	ERP 116152
		R 1/2	ERP 116153
		R 3/4 - préteflonné	ERP 116154
Embout pour flexibles			
		Ø 9 mm	ERP 116809
		Ø 10 mm	ERP 116810
		Ø 13 mm	ERP 116813
		Ø 16 mm	ERP 116816
		Ø 19 mm	ERP 116819

RACCORDS RAPIDES SECURITE PREVO S1 - CSI 06

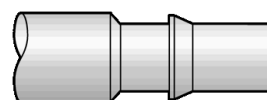

Sécurité anti coup de fouet	Température - 15° C + 70° C	Matière Composite	Utilisation Applications pneumatiques	Passage 6 mm	Pression P.N. 12 bar	Couleur Noir / Noir	Débit sous 6 bar DP 0,6 b = 833 l/min	Poids 37 g (raccord pour tuyau Ø 8 mm)
-----------------------------	-----------------------------	-------------------	---------------------------------------	--------------	----------------------	---------------------	---------------------------------------	--

		A	B	C	D	E	DESIGNATION	REFERENCE
Raccord taraudé femelle								
		55	27	20			G 1/4	CSI 061101
		60.5	27	20			G 3/8	CSI 061102
		66.5	27	26			G 1/2	CSI 061103
Raccord fileté mâle cylindrique avec joint d'étanchéité								
		63	27	20			G 1/4	CSI 061151
		65	27	23			G 3/8	CSI 061152
		69	27	26			G 1/2	CSI 061153
Raccord pour flexibles								
		69.5	27	23			Ø 6 mm	CSI 061806
		69.5	27	23			Ø 8 mm	CSI 061808
		69.5	27	23			Ø 10 mm	CSI 061810
		74.5	27	28			Ø 13 mm	CSI 061813
Raccord orientable taraudé femelle								
		158	27	112			G 3/8	CSI 061102SW
Distributeur fixe à 2 directions taraudé femelle								
		101	68	17			G 1/4	CSI 068101
		116	74	20			G 3/8	CSI 068102
		125	82	25			G 1/2	CSI 068103
Distributeur fixe à 2 directions fileté mâle cylindrique								
		110	75	17			G 1/4	CSI 068151
		116	80	20			G 3/8	CSI 068152
		125	88	25			G 1/2	CSI 068153

RACCORDS RAPIDES SECURITE PREVO S1 - CSI 06

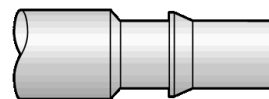

Sécurité anti coup de fouet	Température -15° C + 70° C	Matière Composite	Utilisation Applications pneumatiques	Passage 6 mm	Pression P.N. 12 bar	Couleur Noir / Noir	Débit sous 6 bar DP 0,6 b = 833 l/min	Poids 37 g (raccord pour tuyau Ø 8 mm)
-----------------------------	----------------------------	-------------------	---------------------------------------	--------------	----------------------	---------------------	---------------------------------------	--

		A	B	C	D	E	DESIGNATION	REFERENCE	
Raccord taraudé femelle pour traversée de cloison									
		70.5	27	29	32		G 1/4	CSI 062101	
Applique murale taraudée - 2 raccords et purge manuelle - Profil ISO C - Passage 6 mm									
NOUVEAU 		71	57	38	70	6,5	Entrée taraudée G 1/2	Sortie : 2 raccords 2 raccords CSI 06	CSI 068103WF
		71	57	38	70	6,5	G 3/4	2 raccords CSI 06	CSI 068104WF

EMBOUTS POUR RACCORDS RAPIDES - CRP 06

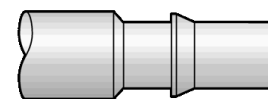

Passage 6 mm	Pression P.N. 16 bar	Précision Respect des tolérances	Matière Acier supérieur
--------------	----------------------	----------------------------------	-------------------------

		A	B	DESIGNATION	REFERENCE
Embout taraudé femelle					
		50	17	G 1/4	CRP 066101
		54	24	G 3/8	CRP 066102
Embout fileté mâle cylindrique					
		48	14	G 1/4	CRP 066151
		52	17	G 3/8	CRP 066152
Embout pour flexibles					
		62		Ø 6 mm	CRP 066806
		62		Ø 8 mm	CRP 066808
		62		Ø 10 mm	CRP 066810
		62		Ø 13 mm	CRP 066813

RACCORDS RAPIDES SECURITE PREVO S1 - CSI 08

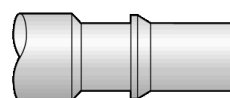



Sécurité anti coup de fouet	Température - 15° C + 70° C	Matière Composite	Utilisation Applications pneumatiques	Passage 8 mm	Pression P.N. 12 bar	Couleur Noir / Noir	Débit sous 6 bar DP 0,6 bar = 2 028 l/min	Poids 57 g (Raccord pour tuyau Ø 8 mm)
-----------------------------	-----------------------------	-------------------	---------------------------------------	--------------	----------------------	---------------------	---	--

		A	B	C	D	E	DESIGNATION	REFERENCE	
Raccord taraudé femelle cylindrique									
		67.5	32	23			G 1/4	CSI 081101	
		67.5	32	23				G 3/8	CSI 081102
		75.5	32	26				G 1/2	CSI 081103
Raccord fileté mâle cylindrique avec joint d'étanchéité									
		75.5	32	23			G 1/4	CSI 081151	
		76.5	32	23				G 3/8	CSI 081152
		78.5	32	26				G 1/2	CSI 081153
Raccord pour flexible									
		81.5	32	23			Ø 8 mm	CSI 081808	
		81.5	32	23				Ø 10 mm	CSI 081810
		86.5	32	28				Ø 13 mm	CSI 081813
		86.5	32	28				Ø 16 mm	CSI 081816
Raccord orientable taraudé femelle									
							Liaison orientable Rotation sur 2 axes à 360°		
		169	32	123				G 3/8	CSI 081102SW
Distributeur fixe à 2 directions taraudé femelle									
		130	83	20			G 3/8	CSI 088102	
		140	90	25				G 1/2	CSI 088103
Distributeur fixe à 2 directions fileté mâle cylindrique									
		135	90	20			G 3/8	CSI 088152	
		140	95	25				G 1/2	CSI 088153

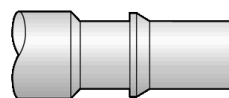
RACCORDS RAPIDES SECURITE PREVO S1 - CSI 08



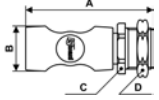

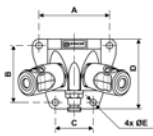

Sécurité anti coup de fouet	Température - 15° C + 70° C	Matière Composite	Utilisation Applications pneumatiques	Passage 8 mm	Pression P.N. 12 bar	Couleur Noir / Noir	Débit sous 6 bar DP 0,6 bar = 2 028 l/min	Poids 57 g (Raccord pour tuyau Ø 8 mm)
-----------------------------	-----------------------------	-------------------	---------------------------------------	--------------	----------------------	---------------------	---	--

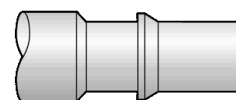
		A	B	C	D	E	DESIGNATION	REFERENCE	
Raccord taraudé femelle pour traversée de cloison									
		82	32	29	32		G 1/2	CSI 082103	
Applique murale taraudée - 2 raccords et purge manuelle - Profil ISO C - Passage 8 mm									
		71	57	38	70	6,5	Entrée taraudée G 1/2	Sortie : 2 raccords 2 raccords CSI 08	CSI 088103WF
		71	57	38	70	6,5	G 3/4	2 raccords CSI 08	CSI 088104WF

EMBOUTS POUR RACCORDS RAPIDES - CRP 08

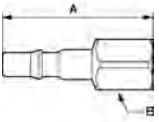

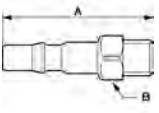
Matière Acier supérieur	Durété Résistance à l'abrasion	Passage 8 mm	Précision Respect des tolérances	Pression P.N. 16 bar
-------------------------	--------------------------------	--------------	----------------------------------	----------------------

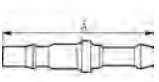
		A	B	DESIGNATION	REFERENCE
Embout taraudé femelle					
		57	19	G 1/4	CRP 086101
		59	24	G 3/8	CRP 086102
		62	24	G 1/2	CRP 086103
Embout fileté mâle cylindrique					
		55	19	G 1/4	CRP 086151
		56	16	G 3/8	CRP 086152
		60	24	G 1/2	CRP 086153
Embout pour flexibles					
		66		Ø 6 mm	CRP 086806
		66		Ø 8 mm	CRP 086808
		66		Ø 10 mm	CRP 086810
		66		Ø 13 mm	CRP 086813
		70		Ø 16 mm	CRP 086816

RACCORDS RAPIDES SECURITE PREVO S1 - ASI 06



Sécurité anti coup de fouet	Température -10°C + 70°C	Matière Composite	Utilisation Applications pneumatiques	Passage 6 mm	Pression P.N. 12 bar	Couleur Noir / Jaune	Débit sous 6 bar 800 l/min - DP = 0,6 b	Poids 74 g (raccord pour tuyau Ø 6 mm)
-----------------------------	--------------------------	-------------------	---------------------------------------	--------------	----------------------	----------------------	---	--

		A	B	C	D	E	DESIGNATION	REFERENCE
Raccord taraudé femelle cylindrique								
		68.6	30	20			G 1/4	ASI 061101
		74	30	20			G 3/8	ASI 061102
		80.1	30	26			G 1/2	ASI 061103
Raccord fileté mâle cylindrique avec joint d'étanchéité								
		76.3	30	20			G 1/4	ASI 061151
		78.3	30	23			G 3/8	ASI 061152
		82.3	30	26			G 1/2	ASI 061153
Raccord pour flexibles								
		83	30	19.4			Ø 6 mm	ASI 061806
		83	30	19.4			Ø 8 mm	ASI 061808
		83	30	19.4			Ø 10 mm	ASI 061810
		88	30	19.4			Ø 13 mm	ASI 061813
Raccord orientable taraudé femelle								
							Liaison orientable Rotation sur 2 axes à 360°	
		172	30	125,3			G 3/8	ASI 061102SW
Distributeur fixe à 2 directions taraudé femelle								
		134	82	17			G 1/4	ASI 068101
		140	87	20			G 3/8	ASI 068102
		150	95	25			G 1/2	ASI 068103
Distributeur fixe à 2 directions fileté mâle cylindrique								
		134	88	17			G 1/4	ASI 068151
		140	92	20			G 3/8	ASI 068152
		150	104	25			G 1/2	ASI 068153

RACCORDS RAPIDES SECURITE PREVO S1 - ASI 06



Sécurité anti coup de fouet	Température -10°C + 70°C	Matière Composite	Utilisation Applications pneumatiques	Passage 6 mm	Pression P.N. 12 bar	Couleur Noir / Jaune	Débit sous 6 bar 800 l/min - DP = 0,6 b	Poids 74 g (raccord pour tuyau Ø 6 mm)
-----------------------------	--------------------------	-------------------	---------------------------------------	--------------	----------------------	----------------------	---	--

		A	B	C	D	E	DESIGNATION	REFERENCE	
Raccord taraudé femelle pour traversée de cloison									
		84	30	29	32		Taraudé femelle G 1/4 Ø de perçage sur platine en mm : 27 Epaisseur de la platine en mm : 2 à 11 mm maxi	ASI 062101	
Applique murale taraudée - 2 raccords et purge manuelle - Profil ARO - Passage 6 mm									
		71	57	38	70	6,5	Entrée taraudée G 1/2	Sortie : 2 raccords 2 raccords ASI 06	ASI 068103WF
		71	57	38	70	6,5	G 3/4	2 raccords ASI 06	ASI 068104WF

EMBOUTS POUR RACCORDS RAPIDES - ARP 06

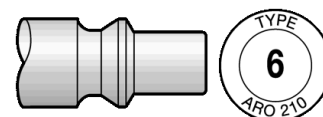

Dureté Résistance à l'abrasion	Passage 6 mm	Précision Constance des côtes	Pression P.N 16 bar	Matière Acier traité Traitement anti-corrosion
--------------------------------	--------------	-------------------------------	---------------------	--

		A	B	DESIGNATION	REFERENCE
Embout taraudé femelle					
		40	15	G 1/4	ARP 066101
		44	21	G 3/8	ARP 066102
Embout fileté mâle conique					
		38.5	13	R 1/4 - prétefflonné	ARP 066151
		44	17	R 3/8 - prétefflonné	ARP 066152
Embout pour flexibles					
		53		Ø 6-7 mm	ARP 066806
		49		Ø 8 mm	ARP 066808
		55		Ø 9 - 10 mm	ARP 066810

RACCORDS RAPIDES SECURITE PREVO S1 - BSI 06

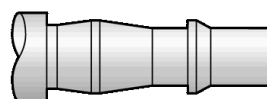

Sécurité anti coup de fouet	Température - 15°C + 70°C	Matière Composite	Utilisation Outils pneumatiques	Passage 6 mm	Pression P.N. 12 bar	Couleur Noir / Orange	Débit sous 6 bar 750 l/min - DP = 0,6 b	Poids 86 g (raccord pour tuyau Ø 6 mm)
-----------------------------	---------------------------	-------------------	---------------------------------	--------------	----------------------	-----------------------	---	--

		A	B	C	D	E	DESIGNATION	REFERENCE
Raccord taraudé femelle cylindrique								
		76.2	30	20			G 1/4	BSI 061101
		81.6	30	20			G 3/8	BSI 061102
		87.7	30	26			G 1/2	BSI 061103
Raccord fileté mâle cylindrique avec joint d'étanchéité								
		83.9	30	20			G 1/4	BSI 061151
		85.9	30	23			G 3/8	BSI 061152
		89.9	30	26			G 1/2	BSI 061153
Raccord pour flexibles								
		90.6	30	19.4			Ø 6 mm	BSI 061806
		90.6	30	19.4			Ø 8 mm	BSI 061808
		90.6	30	19.4			Ø 10 mm	BSI 061810
		95.6	30	19.4			Ø 13 mm	BSI 061813
Raccord orientable taraudé femelle								
		180	30	132.9			G 3/8	BSI 061102SW
Distributeur fixe à 2 directions taraudé femelle								
		137	83	20			G 1/4	BSI 068101
		142	89	23			G 3/8	BSI 068102
		153	95	26			G 1/2	BSI 068103
Distributeur fixe à 2 directions fileté mâle cylindrique								
		137	89	20			G 1/4	BSI 068151
		142	93	23			G 3/8	BSI 068152
		153	106	26			G 1/2	BSI 068153

RACCORDS RAPIDES SECURITE PREVO S1 - BSI 06

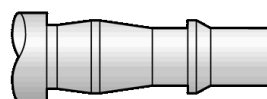

Sécurité anti coup de fouet	Température - 15°C + 70°C	Matière Composite	Utilisation Outils pneumatiques	Passage 6 mm	Pression P.N. 12 bar	Couleur Noir / Orange	Débit sous 6 bar 750 l/min - DP = 0,6 b	Poids 86 g (raccord pour tuyau Ø 6 mm)
-----------------------------	---------------------------	-------------------	---------------------------------	--------------	----------------------	-----------------------	---	--

		A	B	C	D	E	DESIGNATION	REFERENCE	
Raccord taraudé femelle pour traversée de cloison									
		84	30	29	32		Taraudé femelle G 1/4 Ø de perçage sur platine en mm : 27 mm Epaisseur de la platine en mm : 2 à 11 mm maxi	BSI 062101	
Applique murale taraudée - 2 raccords et purge manuelle - Profil British - Passage 6 mm									
		71	57	38	70	6,5	Entrée taraudée G 1/2	Sortie : 2 raccords 2 raccords BSI 06	BSI 068103WF
		71	57	38	70	6,5	G 3/4	2 raccords BSI 06	BSI 068104WF

EMBOUTS POUR RACCORDS RAPIDES - BRP 06

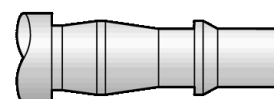

Dureté Résistance à l'abrasion	Passage 6 mm	Précision Constance des côtes	Pression P.N. 16 bar	Matière Acier traité Traitement anticorrosion
-----------------------------------	--------------	----------------------------------	----------------------	--

		A	B	DESIGNATION	REFERENCE
Embout taraudé femelle					
		53	17	G 1/4	BRP 066101
		57	21	G 3/8	BRP 066102
Embout fileté mâle conique					
		55	14	R 1/4	BRP 066151
		57	17	R 3/8	BRP 066152
Embout pour flexibles					
		64		Ø 6 mm	BRP 066806
		68		Ø 8 mm	BRP 066808
		68		Ø 10 mm	BRP 066810

RACCORDS RAPIDES SECURITE PREVO S1 - USI 06

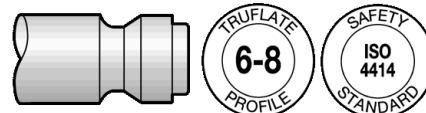



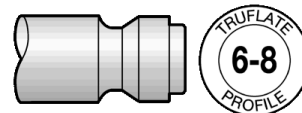

Sécurité anti coup de fouet	Température -15°C + 70°C	Matière Composite	Utilisation Outils pneumatiques	Passage 6 mm	Pression P.N. 12 bar	Couleur Noir / Rouge	Débit sous 6 bar 833 l/min - DP = 0,6 b	Poids 78 g (raccord pour tuyau Ø 6 mm)
-----------------------------	--------------------------	-------------------	---------------------------------	--------------	----------------------	----------------------	---	--

		A	B	C	D	E	DESIGNATION	REFERENCE	
Raccord taraudé femelle cylindrique									
		71	30	20			NPT 1/4	USI 061201	
		75	30	20			NPT 3/8	USI 061202	
		82	30	23			NPT 1/2	USI 061203	
Raccord fileté mâle cylindrique									
		82	30	20			NPT 1/4	USI 061251	
		82	30	20			NPT 3/8	USI 061252	
		88	30	23			NPT 1/2	USI 061253	
Raccord pour flexible									
		86	30	19.4			Ø 8 mm	USI 061808	
		86	30	19.4			Ø 10 mm	USI 061810	
Raccord orientable taraudé femelle									
		175	30	128.3			NPT 3/8	USI 061202SW	
Applique murale taraudée - 2 raccords et purge manuelle - Profil Truflate - Passage 6 mm									
		71	57	38	70	6,5	Entrée taraudée 1/2 NPT	Sortie : 2 raccords 2 raccords USI 06	USI 068203WF
		71	57	38	70	6,5	3/4 NPT	2 raccords USI 06	USI 068204WF

EMBOUITS POUR RACCORDS RAPIDES - URP 06

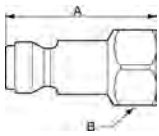

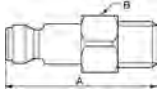
Dureté Résistance à l'abrasion	Passage 6 mm	Précision Constance des côtes	Pression P.N. 16 bar	Matière Acier traité Traitement anti-corrosion
-----------------------------------	-----------------	----------------------------------	-------------------------	--

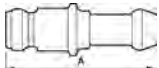
		A	B	DESIGNATION	REFERENCE
Embout taraudé femelle					
		40	17	NPT 1/4	URP 066201
		42	21	NPT 3/8	URP 066202
		48	25	NPT 1/2	URP 066203
Embout fileté mâle conique					
		Filetage préteflonné			
		41	14	NPT 1/4	URP 066251
		48	25	NPT 3/8	URP 066252
		50	22	NPT 1/2	URP 066253
Embout pour flexibles					
		52		Ø 6 mm	URP 066806
		53		Ø 10 mm	URP 066810

RACCORDS RAPIDES SECURITE PREVO S1 - USI 08

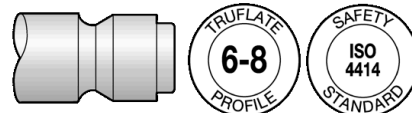



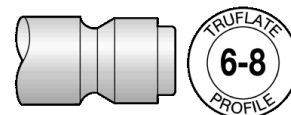

Sécurité anti coup de fouet	Température -15°C + 70°C	Matière Composite	Utilisation Outils pneumatiques	Passage 8 mm	Pression P.N. 12 bar	Couleur Noir / Rouge	Débit sous 6 bar 2 028 l/min - DP = 0,6 b
-----------------------------	--------------------------	-------------------	---------------------------------	--------------	----------------------	----------------------	---

		A	B	C	D	E	DESIGNATION	REFERENCE		
Raccord taraudé femelle cylindrique										
		82.4	33	23			NPT 1/4	USI 081201		
		82.4	33	23				NPT 3/8	USI 081202	
		91.4	33	23				NPT 1/2	USI 081203	
Raccord fileté mâle cylindrique avec joint d'étanchéité										
		94.4	33	23			NPT 1/4	USI 081251		
		94.4	33	23				NPT 3/8	USI 081252	
		98.4	33	23				NPT 1/2	USI 081253	
Raccord pour flexible										
		102.9	33	22.6			Ø 13 mm	USI 081813		
Raccord orientable taraudé femelle										
		184	33	139.2			NPT 3/8	USI 081202SW		
Applique murale taraudée - 2 raccords et purge manuelle - Profil Truflate - Passage 8 mm										
		71	57	38	70	6,5	Entrée taraudée 1/2 NPT	Sortie : 2 raccords 2 raccords USI 08	USI 088203WF	
								3/4 NPT	2 raccords USI 08	USI 088204WF

EMBOUITS POUR RACCORDS RAPIDES - URP 08

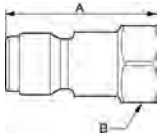

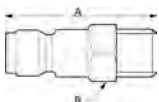
Dureté Résistance à l'abrasion	Passage 8 mm	Précision Constance des côtes	Pression P.N. 16 bar	Matière Acier traité Traitement anti-corrosion
-----------------------------------	-----------------	----------------------------------	-------------------------	--

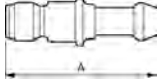
		A	B	DESIGNATION	REFERENCE
Embout taraudé femelle					
		46	17	NPT 1/4	URP 086201
		47	17	NPT 3/8	URP 086202
		50	22	NPT 1/2	URP 086203
Embout fileté mâle cylindrique					
				Filetage préteflonné	
		46	17	NPT 1/4	URP 086251
		47	17	NPT 3/8	URP 086252
		50	22	NPT 1/2	URP 086253
Embout pour flexibles					
		57		Ø 6 mm	URP 086806
		60		Ø 10 mm	URP 086810
		66		Ø 13 mm	URP 086813

RACCORDS RAPIDES SECURITE PREVO S1 METAL - USI 11

Sécurité anti coup de fouet	Température -15°C + 70°C	Matière Métal	Utilisation Outils pneumatiques	Passage 87mm	Pression P.N. 16 bar	Couleur Métal / Rouge	Débit sous 6 bar DP 0,6 b = 2 987 l/min
-----------------------------	--------------------------	---------------	---------------------------------	--------------	----------------------	-----------------------	---

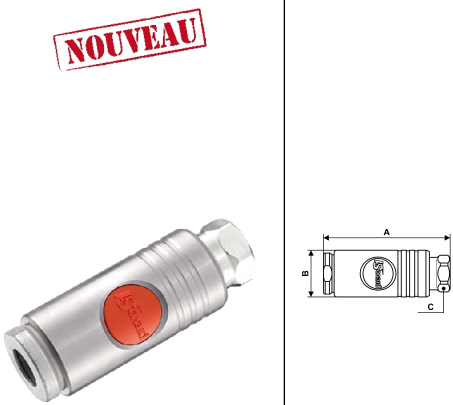
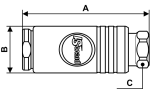
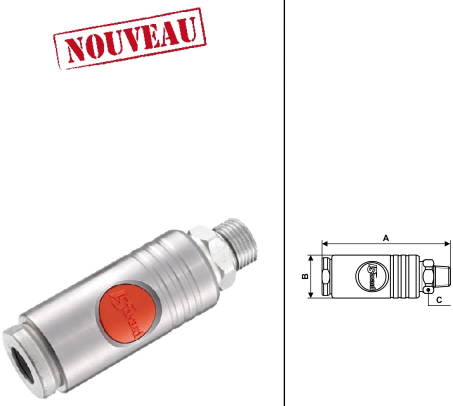
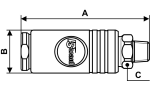
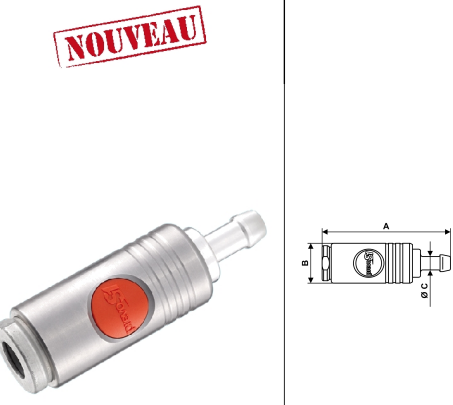
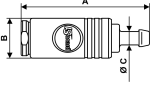
		A	B	C	DESIGNATION	REFERENCE
Raccord taraudé femelle cylindrique						
		99,5	37	26	NPT 3/8	USI 111202
		102	37	26	NPT 1/2	USI 111203
		108	37	30	NPT 3/4	USI 111204
Raccord fileté mâle cylindrique avec joint d'étanchéité						
		112	37	26	NPT 3/8	USI 111252
		116	37	26	NPT 1/2	USI 111253
		118	37	30	NPT 3/4	USI 111254
Raccord pour flexible						
		136,5	37	10	Ø 10 mm	USI 111810
		120,4	37	12,5	Ø 13 mm	USI 111813
		161,5	37	18,5	Ø 19 mm	USI 111819

isg 11

RACCORDS RAPIDES DE SECURITÉ

LA SÉCURITÉ, L'ATOUT N°1 DU RACCORD RAPIDE ISG

La technologie des raccords rapides **ISG**, associée aux embouts réalisés en acier traité, garantissent la solution la plus appropriée pour disposer d'une énergie pneumatique totalement maîtrisée.

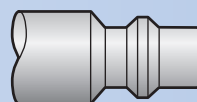

1 Une première translation dans le sens de la flèche permet une décompression en aval de l'air comprimé.

2 Une deuxième translation dans le sens inverse déconnecte l'embout en toute sécurité.

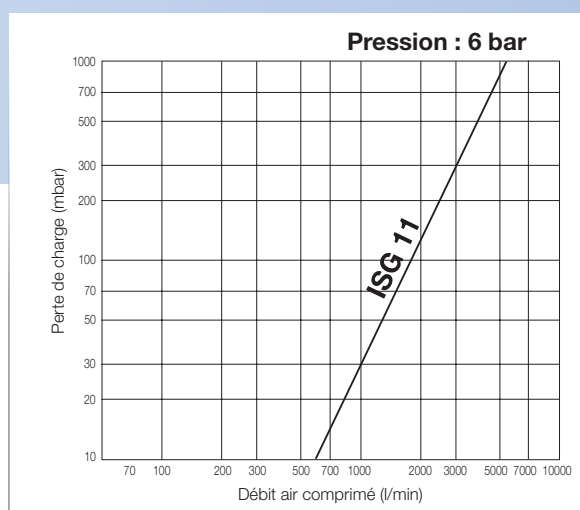



TECHNOLOGIE

Raccord automatique à bague utilisant un système d'accroche à billes et aiguilles :

- ▶ Effort d'accouplement minimum
- ▶ Étanchéité optimale

CONCEPTION BREVETÉE

La technologie des raccords ISG est protégée par les brevets :
U.S. Patents : **5 630 570 - 5 634 624**

SÉCURITÉ

Connexion et déconnexion en toute sécurité.
Mécanisme de décompression garantissant un désaccouplement sans risque de coup de fouet.

Normes ISO 4414

COMPATIBILITÉ

La ligne ISG est compatible avec le profil international **ISO 6150 B**.

IDENTIFICATION

Comme tous les raccords PREVOST, les raccords ISG ont un code couleur qui permet une identification immédiate du profil utilisé.

- **Bleu** : Profil 6150 ISO B

CONNEXION PARFAITE

Les embouts correspondant aux raccords ISG sont réalisés en acier traité avec protection anticorrosion.

Les filetages mâles sont coniques et pré-téflonnés pour un montage rapide et parfaitement étanche.

ANTISTATIQUE

Les raccords ISG sont antistatiques ; cela permet d'éviter l'attraction de poussières sur les surfaces de travail durant l'application de laque ou vernis.

ANTIRAYURE

Le corps du raccord est fabriqué en matériau composite absorbant l'énergie qui prévient tous risques de rayures sur les surfaces fragiles (carrosseries, meubles...). Il est léger et antirayure.

FABRICATION SANS SILICONE

Les raccords de la gamme ISG sont fabriqués sans silicone, ce qui garantit l'usager contre les risques de défauts à l'application de la peinture.

ROBUSTE

Corps en matériau composite.

Haute résistance :

- à l'abrasion
- aux chocs
- à l'écrasement
- aux vibrations

LÉGERS

Grâce à leur construction en matériau composite, les raccords ISG sont légers. Ils permettent à l'utilisateur un travail précis et sans fatigue.

PERFORMANCES







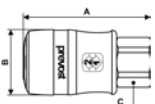

Débit optimal adapté à tous les outils pneumatiques

Ø mm	Débit		Pression de service	Pression maxi	Température d'utilisation
	6 bar	ΔP = 10%			
ISO B - 11 mm	4160 l/min		2 à 12 bar	16 bar	-15°C à +70°C

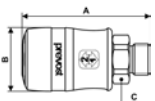
RACCORDS RAPIDES DE SECURITE - ISG 11

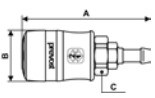

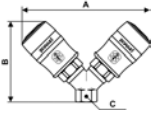

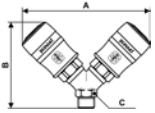

Sécurité anti coup de fouet	Température - 15°C + 70°C	Matière Composite	Utilisation Applications pneumatiques	Passage 11 mm	Pression P.N. 12 bar Mini 2 bar	Couleur Noir / Bleu	Débit sous 6 bar DP 0,6 b = 4 160 l/min	Poids 150 gr
-----------------------------	---------------------------	-------------------	---------------------------------------	---------------	---------------------------------	---------------------	---	--------------

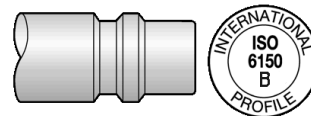
		A	B	C	DESIGNATION	REFERENCE
Raccord taraudé femelle						
		75.4	43	30	G 3/8	ISG 111102
		86	43	30	G 1/2	ISG 111103
		83.7	43	30	G 3/4	ISG 111104
Raccord fileté mâle						
		87	43	30	G 3/8	ISG 111152
		89	43	30	G 1/2	ISG 111153
		91	43	30	G 3/4	ISG 111154
Raccord pour flexibles						
		119	43	30	Ø 9 - 10 mm	ISG 111810
		109	43	30	Ø 13 mm	ISG 111813
		109	43	30	Ø 16 mm	ISG 111816
		156	43	30	Ø 19 mm	ISG 111819
Distributeur fixe à 2 directions taraudé femelle						
		168	113	30	G 1/2	ISG 118103
		176	121	30	G 3/4	ISG 118104
Distributeur fixe à 2 directions fileté mâle cylindrique						
		163	109	30	G 1/2	ISG 118153
		176	141	30	G 3/4	ISG 118154

EMBOUITS POUR RACCORDS RAPIDES - IRP 11

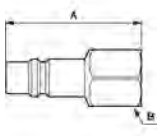

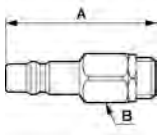
Dureté Résistance à l'abrasion Dureté : 650 Hv	Passage 11 mm	Précision Respect des tolérances	Pression 16 bar	Matière Acier traité - Revêtement anticorrosion
--	------------------	-------------------------------------	--------------------	--

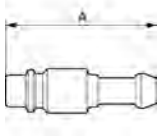
		A	B	DESIGNATION	REFERENCE
Embout taraudé femelle					
		60	25	G 3/8	IRP 116102
		60	25	G 1/2	IRP 116103
Embout fileté mâle conique					
				Filetage préteflonné	
		82	25	R 3/8 - préteflonné	IRP 116152
		84	25	R 1/2 - préteflonné	IRP 116153
Embout pour flexibles					
		65		Ø 9 - 10 mm	IRP 116810
		70		Ø 13 mm	IRP 116813
		69		Ø 16 mm	IRP 116816
		92		Ø 19 mm	IRP 116819

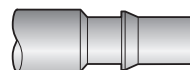

RACCORDS RAPIDES DE SECURITÉ

LES RACCORDS CSM, FIABILITÉ ET PERFORMANCE

- ▶ Sécurité
- ▶ Robustesse
- ▶ Étanchéité

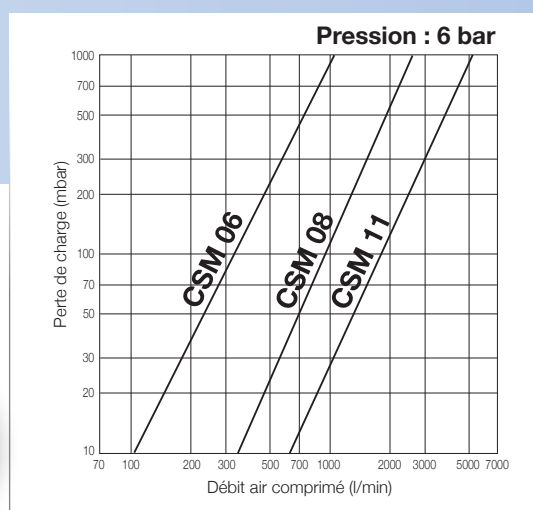
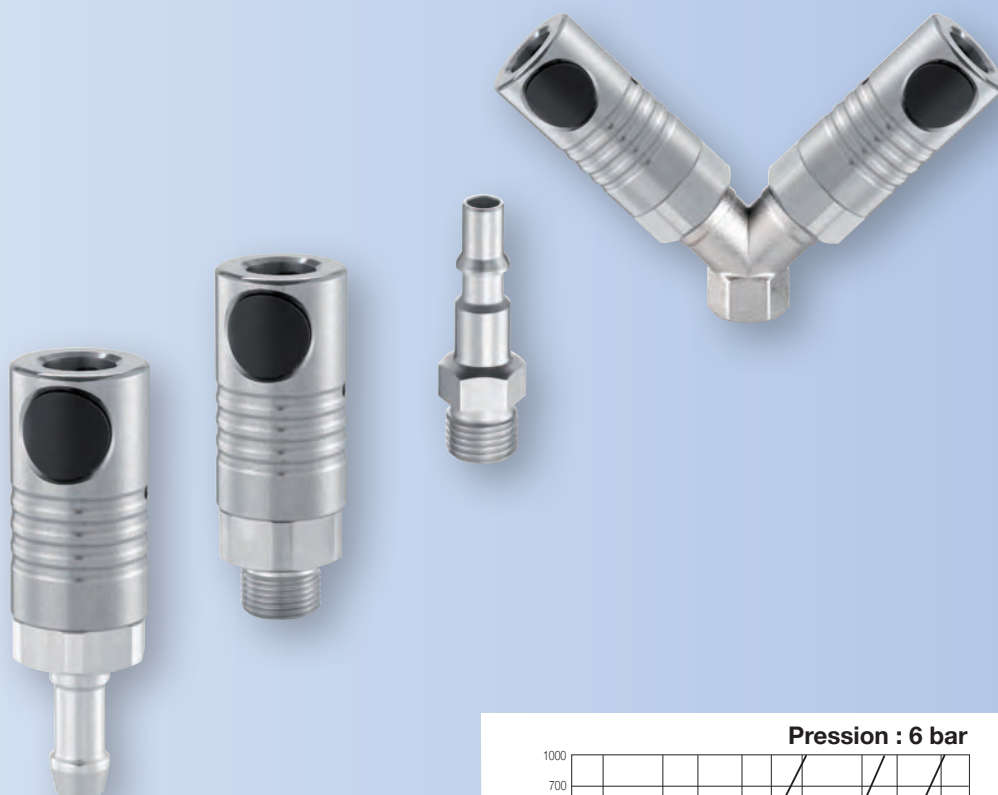

SÉCURITÉ ANTI-COUP DE FOUET

La gamme CSM maîtrise la décompression et le désaccouplement en 2 impulsions :

- ▶ impulsion 1 : décompression automatique du flexible aval
- ▶ impulsion 2 : désaccouplement du raccord en toute sécurité

ÉTANCHÉITÉ

- ▶ La gamme CSM possède une technologie dédiée à l'étanchéité, chaque raccord est contrôlé unitairement
- ▶ Elle participe activement à l'efficacité de vos installations pneumatiques grâce à sa fiabilité et à un excellent débit

COMPATIBILITÉ

Les raccords sont compatibles avec toutes les connexions de profil international

- ▶ Profil ISO 6150 série C :

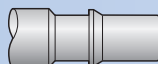

- ▶ 3 diamètres de passage :
 - 6 mm, **CSM 06**
 - 8 mm, **CSM 08**
 - 11 mm, **CSM 11**

FIABILITÉ

- ▶ Mécanisme souple et automatisé
- ▶ Étanchéité optimale

ROBUSTESSE

- ▶ Corps en acier inox aux caractéristiques mécaniques renforcées
- ▶ Résistance :
 - à l'abrasion
 - aux chocs
 - à l'écrasement
 - aux vibrations
 - à la corrosion

AVANTAGES ÉCONOMIQUES

- ▶ Gain de productivité (facilité d'utilisation, durée de vie importante)
- ▶ Réduction des coûts énergétiques (étanchéité longue durée)
- ▶ Rendement maximum des systèmes et outils pneumatiques
- ▶ Fiabilité dans le temps

MATÉRIAUX ÉLABORÉS

- ▶ Corps : acier inox à 17% de chrome
- ▶ Verrou monobloc : acier inox à 13% de chrome
- ▶ Étanchéité : soupape profilée et joint nitrile





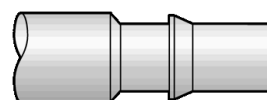

PERFORMANCES

Débit sous 6 bar - $\Delta P = 0,6$ bar			Pression de service		Température	Poids <i>raccords $\varnothing 6$ pour tuyau de $\varnothing 10$ mm</i>
\varnothing de 6 mm	\varnothing de 8 mm	\varnothing de 11 mm	\varnothing de 6 mm	\varnothing de 8 et 11 mm		
833 l/min	2 120 l/min	4 120 l/min	0 à 12 bar	0 à 16 bar	de -15 °C à +70°C	à partir de 70 g

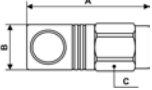
RACCORDS METALLIQUES DE SECURITE - CSM 06

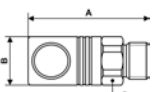

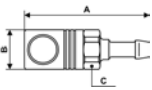
Sécurité ISO 4414	Température - 15°C + 70°C	Matière Acier supérieur	Utilisation Applications pneumatiques	Passage 6 mm	Pression P.N. 12 bar	Couleur Métal / Noir	Débit sous 6 bar DP 0,6b = 833 l/min
----------------------	------------------------------	----------------------------	---	-----------------	-------------------------	-------------------------	---

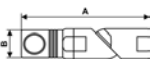
		A	B	C	DESIGNATION	REFERENCE
Raccord taraudé femelle						
 	52.5	22	20	G 1/4	CSM 061101	
	60.5	22	21	G 3/8	CSM 061102	
	63.5	22	25	G 1/2	CSM 061103	
Raccord fileté mâle cylindrique						
 	54.5	22	20	G 1/4	CSM 061151	
	55.5	22	20	G 3/8	CSM 061152	
	57.5	22	23	G 1/2	CSM 061153	
Raccord pour flexibles						
 	71	22	20	Ø 6 mm	CSM 061806	
	71	22	20	Ø 8 mm	CSM 061808	
	71	22	20	Ø 10 mm	CSM 061810	
	76	22	20	Ø 13 mm	CSM 061813	
Raccord orientable taraudé femelle						
 	103	24		Rotation sur 2 axes à 360° G 3/8	CSM 061102SW	

RACCORDS METALLIQUES DE SECURITE - CSM 06

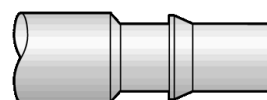

Sécurité ISO 4414	Température - 15°C + 70°C	Matière Acier supérieur	Utilisation Applications pneumatiques	Passage 6 mm	Pression P.N. 12 bar	Couleur Métal / Noir	Débit sous 6 bar DP 0,6b = 833 l/min
----------------------	------------------------------	----------------------------	---	-----------------	-------------------------	-------------------------	---

		A	B	C	DESIGNATION	REFERENCE
Distributeur fixe à 2 directions taraudé femelle						
		101	66	17	G 1/4	CSM 068101
		104	68	19	G 3/8	CSM 068102
		112	75	25	G 1/2	CSM 068103
Distributeur fixe à 2 directions fileté mâle cylindrique						
		101	71	17	G 1/4	CSM 068151
		104	75	20	G 3/8	CSM 068152
		112	85	25	G 1/2	CSM 068153

EMBOUTS POUR RACCORDS RAPIDES - CRP 06

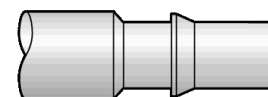

Passage 6 mm	Pression P.N. 16 bar	Précision Respect des tolérances	Matière Acier supérieur
-----------------	-------------------------	-------------------------------------	----------------------------

		A	B	DESIGNATION	REFERENCE
Embout taraudé femelle					
		50	17	G 1/4	CRP 066101
		54	24	G 3/8	CRP 066102
Embout fileté mâle cylindrique					
		48	14	G 1/4	CRP 066151
		52	17	G 3/8	CRP 066152
Embout pour flexibles					
		62		Ø 6 mm	CRP 066806
		62		Ø 8 mm	CRP 066808
		62		Ø 10 mm	CRP 066810
		62		Ø 13 mm	CRP 066813

RACCORDS METALLIQUES DE SECURITE - CSM 08

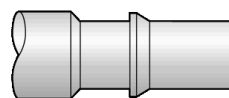

Sécurité ISO 4414	Température - 15°C + 70°C	Matière Acier supérieur	Utilisation Applications pneumatiques	Passage 8 mm	Pression P.N. 16 bar	Couleur Métal / Noir	Débit sous 6 bar DP 0,6b = 2120 l/min
----------------------	------------------------------	----------------------------	---	-----------------	-------------------------	-------------------------	---

		A	B	C	DESIGNATION	REFERENCE
Raccord taraudé femelle						
		68.5	27	25	G 1/4	CSM 081101
		69.5	27	25	G 3/8	CSM 081102
		74.5	27	25	G 1/2	CSM 081103
Raccord fileté mâle cylindrique						
		72	27	25	G 1/4	CSM 081151
		73	27	25	G 3/8	CSM 081152
		75	27	25	G 1/2	CSM 081153
Raccord pour flexibles						
		87	27	25	Ø 8 mm	CSM 081808
		87	27	25	Ø 10 mm	CSM 081810
		92	27	25	Ø 13 mm	CSM 081813
		92	27	25	Ø 16 mm	CSM 081816
Raccord orientable taraudé femelle						
		120	27		Rotation sur 2 axes à 360° G 3/8	CSM 081102SW

RACCORDS METALLIQUES DE SECURITE - CSM 08



Sécurité ISO 4414	Température - 15°C + 70°C	Matière Acier supérieur	Utilisation Applications pneumatiques	Passage 8 mm	Pression P.N. 16 bar	Couleur Métal / Noir	Débit sous 6 bar DP 0,6b = 2120 l/min
----------------------	------------------------------	----------------------------	---	-----------------	-------------------------	-------------------------	---

		A	B	C	DESIGNATION	REFERENCE
Distributeur fixe à 2 directions taraudé femelle						
		132	84	20	G 3/8	CSM 088102
		140	90	25	G 1/2	CSM 088103
		150	110	25	G 3/4	CSM 088104
Distributeur fixe à 2 directions fileté mâle cylindrique						
		132	88	20	G 3/8	CSM 088152
		140	98	25	G 1/2	CSM 088153
		150	130	32	G 3/4	CSM 088154

EMBOUTS POUR RACCORDS RAPIDES - CRP 08

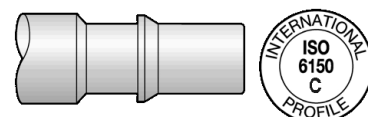

Matière Acier supérieur	Dureté Résistance à l'abrasion	Passage 8 mm	Précision Respect des tolérances	Pression P.N. 16 bar
----------------------------	-----------------------------------	-----------------	-------------------------------------	-------------------------

		A	B	DESIGNATION	REFERENCE
Embout taraudé femelle					
		57	19	G 1/4	CRP 086101
		59	24	G 3/8	CRP 086102
		62	24	G 1/2	CRP 086103
Embout fileté mâle cylindrique					
		55	19	G 1/4	CRP 086151
		56	16	G 3/8	CRP 086152
		60	24	G 1/2	CRP 086153
Embout pour flexibles					
		66		Ø 6 mm	CRP 086806
		66		Ø 8 mm	CRP 086808
		66		Ø 10 mm	CRP 086810
		66		Ø 13 mm	CRP 086813
		70		Ø 16 mm	CRP 086816

RACCORDS METALLIQUES DE SECURITE - CSM 11

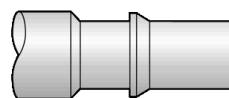



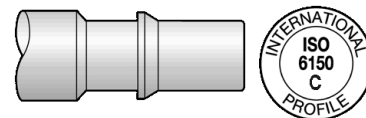

Sécurité ISO 4414	Température - 15°C + 70°C	Matière Acier supérieur	Utilisation Applications pneumatiques	Passage 11 mm	Pression P.N. 16 bar	Couleur Métal / Noir	Débit sous 6 bar DP 0,6 b = 4 120 l/min
----------------------	------------------------------	----------------------------	---	------------------	-------------------------	-------------------------	---

		A	B	C	DESIGNATION	REFERENCE
Raccord taraudé femelle						
		84	33	30	G 3/8	CSM 111102
		87	33	30	G 1/2	CSM 111103
		92	33	30	G 3/4	CSM 111104
Raccord fileté mâle cylindrique						
		94	33	30	G 3/8	CSM 111152
		96	33	30	G 1/2	CSM 111153
		98	33	30	G 3/4	CSM 111154
Raccord pour flexibles						
		119	33	30	Ø 10 mm	CSM 111810
		112	33	30	Ø 13 mm	CSM 111813
		111	33	30	Ø 16 mm	CSM 111816
		147	33	30	Ø 19 mm	CSM 111819
Distributeur fixe à 2 directions taraudé femelle						
		173	106	25	G 1/2	CSM 118103
		184	127	25	G 3/4	CSM 118104
Distributeur fixe à 2 directions fileté mâle cylindrique						
		173	115	25	G 1/2	CSM 118153
		183	150	32	G 3/4	CSM 118154

EMBOUITS POUR RACCORDS RAPIDES - CRP 11

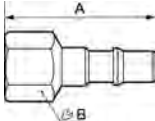

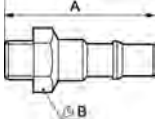
Passage 11 mm	Pression P.N. 16 bar	Précision Respect des tolérances	Dureté Résistance à l'abrasion	Matière Acier supérieur
------------------	-------------------------	-------------------------------------	-----------------------------------	----------------------------

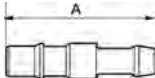
		A	B	DESIGNATION	REFERENCE
Embout taraudé femelle					
 		66	24	G 3/8	CRP 116102
		66	27	G 1/2	CRP 116103
		69	32	G 3/4	CRP 116104
Embout fileté mâle cylindrique					
 		64	24	G 3/8	CRP 116152
		65	24	G 1/2	CRP 116153
		69	32	G 3/4	CRP 116154
Embout pour flexibles					
 		72		Ø 9-10 mm	CRP 116810
		72		Ø 13 mm	CRP 116813
		72		Ø 16 mm	CRP 116816
		96		Ø 19 mm	CRP 116819

RACCORDS RAPIDES STANDARDS

LES RACCORDS PROLAC, LE GESTE NATUREL

Les raccords PROLAC se connectent par simple poussée de l'embout dans le raccord et se déconnectent instantanément par pression sur le bouton. Le procédé de déconnexion / obturation par poussée sur un bouton est un geste naturel. Un simple mouvement du pouce apporte à l'utilisateur plus de confort de travail. En cas de choc, la construction spéciale en résine acétal évite les rayures sur la carrosserie.

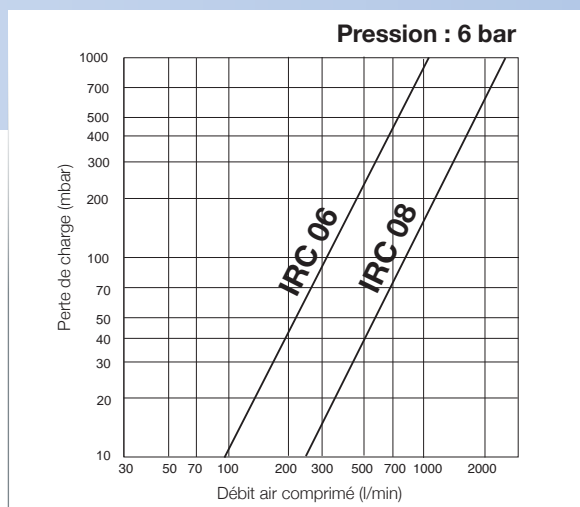



FIABILITÉ

Construction monobloc en matériau composite.
La construction monobloc, parfaitement cylindrique, permet l'utilisation dans tous les environnements de travail.

CONCEPTION

Aucune pièce n'est débordante à l'extérieur du raccord ce qui évite les accrochages et les déconnexions accidentelles.
Le circuit d'air s'ouvre lorsque l'embout est en place.

ÉTANCHÉITÉ

Le couple, raccord rapide associé à l'embout Prevost, assure une étanchéité parfaite sur 3 zones :

- ▶ Embout sur joint torique
- ▶ Joint de soupape fixé par son siège
- ▶ Joint massif de la chambre d'obturation

ERGONOMIE

Les raccords IRC sont conçus pour faciliter les mouvements de l'utilisateur. Ils sont simples à utiliser, légers et peu encombrants.
Leur légèreté permet d'optimiser le rendement et le confort de travail.
La construction du corps en résine évite les rayures sur les carrosseries.

OPTION ORIENTABLE

La libre rotation sur 360° permet une manipulation parfaite de l'outil.

La rotule supprime les contraintes du tuyau (enroulements incontrôlés, entortillements).

La manipulation devient aisée pour les pistolets de peinture, les outils pneumatiques et les travaux de précision.

RACCORD INOX PROXI

- ▶ Construction externe : matériau composite compatible avec les ambiances corrosives*
- ▶ Construction interne : acier inox haute résistance*
 - Obturateur : inox 316 L
- ▶ Fluides véhiculés :
 - Air comprimé en ambiance corrosive
 - Eaux froide et chaude jusqu'à 60°C
 - Gaz neutres de -15°C à +60°C

(* Nous consulter pour les compatibilités)

Préconisation des raccords Prolac sur outils pneumatiques

Sous 6 bar ΔP : 10%		IRC 06		IRC 08	
OUTILS PNEUMATIQUES	Poids de l'outil (kg)	Consommation instantanée (l/min à 6 bar)	Poids de l'outil (kg)	Consommation instantanée (l/min à 6 bar)	
Visseuse	0,3 à 1,2	de 200 à 600			
Ponceuse vibrante	1 à 2	de 300 à 450			
Meuleuse droite	0,25 à 1,6	de 120 à 700	2,5 à 5		de 1000 à 1600
Meuleuse d'angle	0,5 à 1,5	de 300 à 800	1,6 à 3		de 850 à 1100
Meuleuse verticale			0,25 à 5		de 1000 à 1600
Ponceuse verticale			2,5 à 6		de 1100 à 1500
Marteau piqueur	0,5 à 1,9	de 350 à 800	4 à 7		de 1000 à 1600
Perceuse	1 à 2	de 180 à 500	6 à 9		de 1300 à 1800
Perceuse	0,7 à 2,5	de 330 à 800	6 à 9		de 1300 à 1800
Clé à chocs	1 à 4	de 300 à 400	6 à 15		de 800 à 1600
Pompe pneumatique		de 300 à 400			
Pistolet à peinture		de 300 à 400			
Soufflette		de 200 à 400			
IRC 06		833 l/min			
IRC 08					1950-1666 l/min

RACCORDS RAPIDES STANDARDS - IRC 06

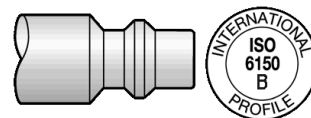

Température - 15°C + 70°C		Matière Composite		Passage 6 mm		Pression P.N. 12 bar		Couleur Bleu / Métal		Débit sous 6 bar DP 0.6b - 800 l/min		Poids	
		A	B	C	D	DESIGNATION				REFERENCE			
Raccord taraudé femelle													
		54	28	23		G 1/4				IRC 061101			
		62	28	23		G 3/8				IRC 061102			
		65	28	25		G 1/2				IRC 061103			
Raccord fileté mâle cylindrique													
		62	28	23		G 1/4				IRC 061151			
		62	28	23		G 3/8				IRC 061152			
		64	28	23		G 1/2				IRC 061153			
Raccord pour flexibles													
		78	28	23		Ø 6 mm				IRC 061806			
		78	28	23		Ø 8 mm				IRC 061808			
		78	28	23		Ø 9 - 10 mm				IRC 061810			
		78	28	23		Ø 13 mm				IRC 061813			
Raccord à coiffe pour flexibles													
		80	19	17	23	Ø 6 x 12 mm - Ø 6 x 11 mm				IRC 061806CO			
		83	22	22	23	Ø 8 x 14 mm - Ø 8 x 13 mm				IRC 061808CO			
		83	24	22	23	Ø 9 x 15 mm - Ø 9 x 14 mm				IRC 061809CO			
		83	24	22	23	Ø 10 x 16 mm - Ø 10 x 15 mm				IRC 061810CO			
Raccord orientable taraudé femelle													
						Raccord orientable							
		157.7	41	40		G 1/4				IRC 061101FA			
		157.7	41	40		G 3/8				IRC 061102FA			
Raccord orientable pour flexibles													
						Raccord orientable							
		157.7	41	40		Ø 6-7 mm				IRC 061806FA			
		157.7	41	40		Ø 8 mm				IRC 061808FA			
		157.7	41	40		Ø 9 - 10 mm				IRC 061810FA			
		157.7	41	40		Ø 13 mm				IRC 061813FA			

RACCORDS RAPIDES STANDARDS - IRC 06

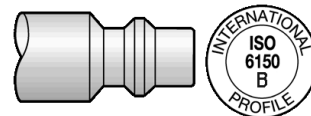

Température - 15°C + 70°C	Matière Composite	Passage 6 mm	Pression P.N. 12 bar	Couleur Bleu / Métal	Débit sous 6 bar DP 0.6b - 800 l/min	Poids	
		A	B	C	D	DESIGNATION	REFERENCE
Distributeur fixe à 2 directions taraudé femelle							
		116	77	23		G 1/4	IRC 068101
		120	82	23		G 3/8	IRC 068102
		128	93	23		G 1/2	IRC 068103
Distributeur fixe à 2 directions fileté mâle cylindrique							
		114	77	23		G 1/4	IRC 068151
		115	80	23		G 3/8	IRC 068152
		123	90	23		G 1/2	IRC 068153

EMBOUTS POUR RACCORDS RAPIDES - IRP 06

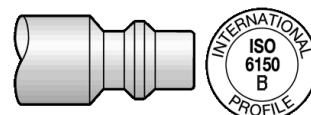



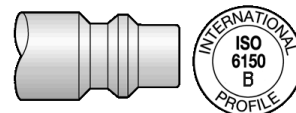

Passage 6 mm	Pression P.N. 16 bar	Précision Respect des tolérances	Matière Acier traité Revêtement anti-corrosion	Durété Résistance à l'abrasion			
		A	B	C	D	DESIGNATION	REFERENCE
Embout taraudé femelle							
		40.5	15			G 1/4	IRP 066101
		43	14			G 1/4 avec cône d'étanchéité	IRP 066101AE
		45	21			G 3/8	IRP 066102
		34	14			Pas Michelin (pas 0,8). Convient au pistolet de gonflage	IRP 066310
		44	17			Devilbiss (pas 9/16" - 20 filets au pouce)	IRP 066315
		41	17			1/4 NPS M	IRP 066301
		43	14			14/125 avec cône d'étanchéité	IRP 066314
Embout fileté mâle conique							
						Filetage préteflonné	
		39.5	13			R 1/4 - préteflonné	IRP 066151
		42	17			R 3/8 - préteflonné	IRP 066152
						14/125 - cylindrique	IRP 066354
Embout pour flexibles							
		49				Ø 6 - 7 mm	IRP 066806
		50				Ø 8 mm	IRP 066808
		50				Ø 9 - 10 mm	IRP 066810
		85				Ø 13 mm	IRP 066813
Embout à coiffe pour flexibles							
		76	17	17	19	Ø 6 x 12 mm - Ø 6 x 11 mm	IRP 066806CO
		79	17	22	24	Ø 8 x 14 mm - Ø 8 x 13 mm	IRP 066808CO
		79	17	22	24	Ø 9 x 15 mm - Ø 9 x 14 mm	IRP 066809CO
		79	17	22	24	Ø 10 x 16 mm - Ø 10 x 15 mm	IRP 066810CO

RACCORDS RAPIDES STANDARDS - IRC 08

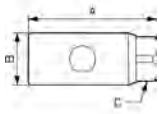

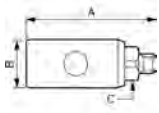
Température - 15°C + 70°C	Matière Composite	Utilisation Applications pneumatiques	Passage 8 mm	Pression P.N. 12 bar	Couleur Bleu / Bleu	Débit sous 6 bar DP 0.6b = 1950 l/min	Poids
------------------------------	----------------------	---	-----------------	-------------------------	------------------------	---	-------

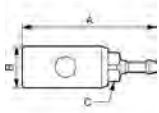
		A	B	C	DESIGNATION	REFERENCE
Raccord taraudé femelle						
		83.5	33	25	G 1/4	IRC 081101
		84.5	33	25	G 3/8	IRC 081102
		93.5	33	25	G 1/2	IRC 081103
Raccord fileté mâle cylindrique						
		90.5	33	25	G 1/4	IRC 081151
		91.5	33	25	G 3/8	IRC 081152
		93.5	33	25	G 1/2	IRC 081153
Raccord pour flexibles						
		104.5	33	25	Ø 8 mm	IRC 081808
		104.5	33	25	Ø 9 - 10 mm	IRC 081810
		109.5	33	25	Ø 13 mm	IRC 081813
		109.5	33	25	Ø 16 mm	IRC 081816

RACCORDS RAPIDES STANDARDS - IRC 08

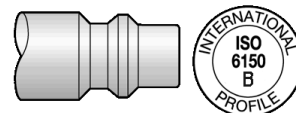

Température - 15°C + 70°C	Matière Composite	Utilisation Applications pneumatiques	Passage 8 mm	Pression P.N. 12 bar	Couleur Bleu / Bleu	Débit sous 6 bar DP 0.6b = 1950 l/min	Poids
Raccord orientable taraudé femelle			A	B	C	DESIGNATION	REFERENCE
		185.2	68.5	40	Raccord orientable G 1/4	IRC 081101FA	
		185.2	68.5	40	G 3/8	IRC 081102FA	
Raccord orientable pour flexibles			A	B	C	DESIGNATION	REFERENCE
		185.2	68.5	40	Raccord orientable Ø 8 mm	IRC 081808FA	
		185.2	68.5	40	Ø 10 mm	IRC 081810FA	
		185.2	68.5	40	Ø 13 mm	IRC 081813FA	

EMBOUTS POUR RACCORDS RAPIDES - IRP 08

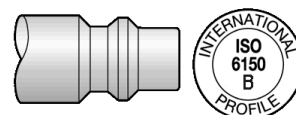

Dureté Résistance à l'abrasion	Passage 8 mm	Précision Respect des tolérances	Pression 16 bar	Matière Acier traité Revêtement anticorrosion	
Embout taraudé femelle		A	B	DESIGNATION	REFERENCE
		45	17	G 1/4	IRP 086101
		49	21	G 3/8	IRP 086102
		53	28	G 1/2	IRP 086103
Embout fileté mâle conique		A	B	DESIGNATION	REFERENCE
				Filetage prétéflonné	
		44.5	17	R 1/4 - prétéflonné	IRP 086151
		44.5	17	R 3/8 - prétéflonné	IRP 086152
55	22	R 1/2 - prétéflonné	IRP 086153		
Embout pour flexibles		A	B	DESIGNATION	REFERENCE
		62		Ø 8 mm	IRP 086808
		53.5		Ø 9 - 10 mm	IRP 086810
		59		Ø 13 mm	IRP 086813
		60		Ø 16 mm	IRP 086816

RACCORDS METALLIQUES STANDARDS - IRM 06

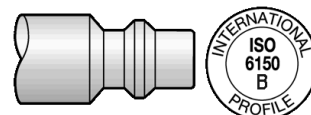

Température -15°C +70°C	Matière Acier traité	Utilisation Applications pneumatiques	Passage 6 mm	Pression P.N. 16 bar	Couleur Métal	Débit sous 6 bar DP 0,6b = 750 l/min	Robuste
----------------------------	-------------------------	---	-----------------	-------------------------	------------------	---	---------

		A	B	C	D	DESIGNATION	REFERENCE
Raccord taraudé femelle							
		52.5	26	23		G 1/4	IRM 061101
		60.5	26	23		G 3/8	IRM 061102
		83.5	26	25		G 1/2	IRM 061103
		54.5	26	23		14/125	IRM 061314
Raccord fileté mâle cylindrique							
		60.5	26	23		G 1/4	IRM 061151
		60.5	26	23		G 3/8	IRM 061152
		62.5	26	23		G 1/2	IRM 061153
Raccord pour flexibles							
		76.5	26	23		Ø 6-7 mm	IRM 061806
		76.5	26	23		Ø 8 mm	IRM 061808
		76.5	26	23		Ø 9-10 mm	IRM 061810
		81.5	26	23		Ø 13 mm	IRM 061813
Raccord pour traversée de cloison							
		52.5	26	32	23	Taraudé femelle G 1/4 Ø perçage sur platine : 27 mm Epaisseur de la platine : 2 à 11 mm maxi	IRM 062101

RACCORDS METALLIQUES STANDARDS - IRM 06

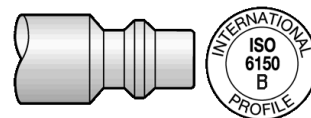

Température -15°C +70°C	Matière Acier traité	Utilisation Applications pneumatiques	Passage 6 mm	Pression P.N. 16 bar	Couleur Métal	Débit sous 6 bar DP 0,6b = 750 l/min	Robuste	
			A	B	C	D	DESIGNATION	REFERENCE
Distributeur fixe à 2 directions taraudé femelle								
		112	75	23		G 1/4	IRM 068101	
		117.5	82	23		G 3/8	IRM 068102	
		125.5	92	23		G 1/2	IRM 068103	
Distributeur fixe à 2 directions fileté mâle cylindrique								
		111.5	76	23		G 1/4	IRM 068151	
		112.5	78	23		G 3/8	IRM 068152	
		120	88	23		G 1/2	IRM 068153	

EMBOUTS POUR RACCORDS RAPIDES - IRP 06

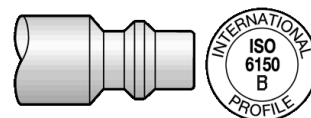

Passage 6 mm	Pression P.N. 16 bar	Précision Respect des tolérances	Matière Acier traité Revêtement anti-corrosion	Durété Résistance à l'abrasion			
		A	B	C	D	DESIGNATION	REFERENCE
Embout taraudé femelle							
		40.5	15			G 1/4	IRP 066101
		43	14			G 1/4 avec cône d'étanchéité	IRP 066101AE
		45	21			G 3/8	IRP 066102
		34	14			Pas Michelin (pas 0,8). Convient au pistolet de gonflage	IRP 066310
		44	17			Devilbiss (pas 9/16" - 20 filets au pouce)	IRP 066315
		41	17			1/4 NPS M	IRP 066301
		43	14			14/125 avec cône d'étanchéité	IRP 066314
Embout fileté mâle conique							
						Filetage préteflonné	
		39.5	13			R 1/4 - préteflonné	IRP 066151
		42	17			R 3/8 - préteflonné	IRP 066152
		43	17			14/125 - cylindrique	IRP 066354
Embout pour flexibles							
		49				Ø 6 - 7 mm	IRP 066806
		50				Ø 8 mm	IRP 066808
		50				Ø 9 - 10 mm	IRP 066810
		85				Ø 13 mm	IRP 066813
Embout à coiffe pour flexibles							
		76	17	17	19	Ø 6 x 12 mm - Ø 6 x 11 mm	IRP 066806CO
		79	17	22	24	Ø 8 x 14 mm - Ø 8 x 13 mm	IRP 066808CO
		79	17	22	24	Ø 9 x 15 mm - Ø 9 x 14 mm	IRP 066809CO
		79	17	22	24	Ø 10 x 16 mm - Ø 10 x 15 mm	IRP 066810CO

RACCORDS RAPIDES STANDARDS INOX - PROXI 06

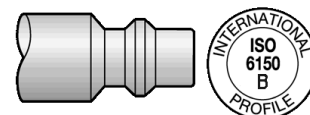







Température -15°C à + 60°C	Matière Corps composite + acier inox	Matière Embout acier inox	Utilisation alimentaire Air comprimé alimentaire	Ambiance corrosive	Passage 6 mm	Pression P.N. 12 bar	Débit sous 6 bar DP 0,6b = 800 l/min
-------------------------------	--	------------------------------	---	-----------------------	-----------------	-------------------------	---

		A	B	C	DESIGNATION	REFERENCE
Raccord taraudé femelle						
		54	28	23	G 1/4	PROXI 061101
		62	28	23	G 3/8	PROXI 061102
		65	28	25	G 1/2	PROXI 061103
Raccord fileté mâle cylindrique						
		62	28	23	G 1/4	PROXI 061151
		62	28	23	G 3/8	PROXI 061152
		64	28	23	G 1/2	PROXI 061153
Raccord pour flexibles						
		78	28	23	Ø 6-7 mm	PROXI 061806
		78	28	23	Ø 8 mm	PROXI 061808
		78	28	23	Ø 9 - 10 mm	PROXI 061810
Embout taraudé femelle						
		40	17		G 1/4	PROXI 066101
Embout fileté mâle conique						
		65	17	16	R 1/4	PROXI 066151
		65	17	20	R 3/8	PROXI 066152
Embout pour flexibles						
		69	17		Ø 6-7 mm	PROXI 066806
		69	17		Ø 8 mm	PROXI 066808
		69	17		Ø 9-10 mm	PROXI 066810

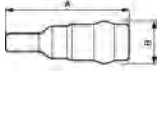

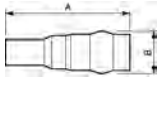
ASSORTIMENT RACCORDS ET EMOBOTS

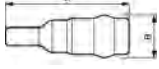
Présentation en boîte plastique	Raccordement Raccord rapide de sécurité	Utilisation Industrie	Utilisation Carrosserie	Utilisation Automobile
DESIGNATION			REFERENCE	
Coffret de dépannage pour garages et ateliers				
		Comprenant : 2 raccords G 1/4 femelle - ISI 061101 2 embouts G 1/4 femelle - IRP 066101 1 embout G 1/4 femelle avec cône d'étanchéité - IRP 066101AE 2 embouts G 1/4 mâle - IRP 066151 2 embouts pour flexibles Ø int. 8 mm - IRP 066808 2 jonctions filetés G 1/4 mâles pour tube Ø 8 mm - JFT 1408 2 colliers de serrage à oreilles - 1315 2 colliers de serrage à oreilles - 1517		
		Boîte raccords et embouts Profil ISO B		
Boîte d'assortiment raccords sécurité et embouts				
		Comprenant : 1 soufflette - STL 101 2 raccords de sécurité G 1/4 BSP femelle - ISI 061101 2 embouts R 1/4 BSP mâle - IRP 066151 2 embouts G 1/4 BSP femelle - IRP 066101 2 embouts pour flexibles Ø int. 8 mm - IRP 066808 2 jonctions G 1/4 pour tuyau int. Ø 8 mm - JFT 1408 2 mamelons G 1/4 BSP mâle-mâle - A2 1414		
		Boîte raccords et embouts Profil ISO B, et soufflette		
Kit de création pour rallonge de tuyau Ø 10 mm				
		Boîte contenant : - 1 raccord rapide orientable - 3 embouts pour raccords rapides - 1 soufflette de poche équipée d'un embout - 1 jonction pour tuyau Ø 10 mm - 2 colliers à oreilles		
		Boîte raccord, accessoires et soufflette -Profil ISOB		
Boîte raccord, accessoires et soufflette - Profil européen 7,2 - 7,4		BTE ESW		

PROTECTEURS POUR RACCORDS RAPIDES

Température 0°C +70°C	Matière Polyuréthane et caoutchouc	Anti rayures	Ergonomie		
Protecteurs NSB pour raccords Ø 6 Pour flexibles Ø ext 14 à 16 mm					
			Pour ISI 06, ISC 06; IRC 06 ; IRM 06 ; CSC 06 ; CSM 06 ; CRC 06; ERC 07, ESI 07; BSI 06; BSC 06; Proxi 06		
		96	35	Jaune	NSB 06J
		96	35	Rouge	NSB 06R
		96	35	Vert	NSB 06V
96	35	Bleu	NSB 06B		
Protecteurs NSB pour raccords Ø 6 Pour flexibles Ø ext 17 à 19 mm					
			Pour ISI 06; ISC 06; IRC 06; IRM 06; CSC 06; CRC 06; CSM 06; ERC 07; ESI 07; BSI 06; BSC 06; Proxi 06		
		96	35	Jaune	NSB 0617J
		96	35	Rouge	NSB 0617R
		96	35	Vert	NSB 0617V
96	35	Bleu	NSB 0617B		
Protecteurs NSB pour raccords Ø 8 Pour flexibles Ø ext. 10 à 19 mm					
		118	35	Noir	NSB 08N
Protecteur caoutchouc pour raccord orientable					
		118	40	Protecteur caoutchouc pour raccord orientable FA	NSB FA

RACCORDS RAPIDES AVEC LUBRIFICATEUR DE LIGNE

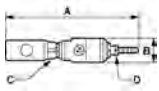
Matière Corps aluminium cuve polycarbonate	Température 0 °C à 60 °C	Lubrification Brouillard d'huile	Capacité 12 cm ³	3000 utilisations	Débit 1400 l/min Lub'Air seul	Pression 12 bar	Montage possible dans les 2 sens
Ensemble Lub'Air pour raccords monté étanche avec différents profils							
		151	33	23	14	IRC 06	LUBAIR 6000
		183	33	25	17	IRC 08	LUBAIR 8000
		68	33	19	-	Lubrificateur de ligne seul	LUBAIR 14F
Ensemble Lub'Air pour flexibles							
		154	33	23	14	Pour flexibles Ø 6 avec IRC 06	LUBAIR 63806
		154	33	23	14	Pour flexible Ø 8 avec IRC 06	LUBAIR 63808
		154	33	23	14	Pour flexibles Ø 8 avec CRC 06	LUB 63808C
		169	33	23	14	Pour flexibles Ø 9 avec ERC 07	LUBAIR 73809
		154	33	23	17	Pour flexibles Ø 10 avec IRC 06	LUBAIR 63810
		166	33	25	14	Pour flexibles Ø 8 avec CRC 08	LUB 83808C

air respirable

RACCORDS ET FLEXIBLES AIR RESPIRABLE

SOUPLESSE ET SÉCURITÉ



Pression : 6 bar

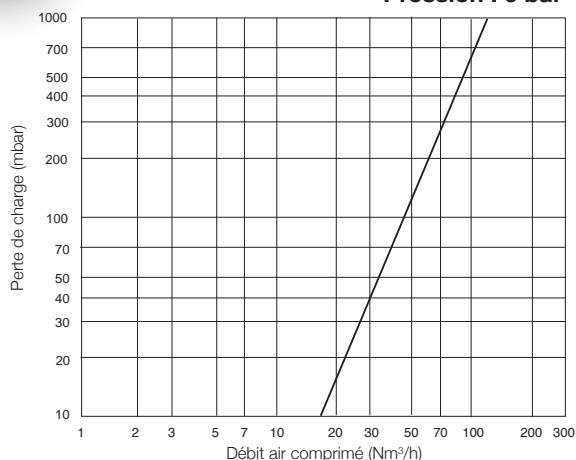

CARACTÉRISTIQUES TECHNIQUES

- Ø de passage en mm : 7,4
- Section en mm : 40,6
- Débit sous 6 bar ΔP 1bar : 106,5 Nm³/h
- Pression maxi de service à 20°C : 10 bar
- Poids : 115 g
- Température d'utilisation : - 20° à + 60°C
- Autres conditions, nous consulter

> MATIÈRE RACCORD

- Corps : laiton chromé
- Bague de verrouillage : acier chromé
- Ressort et billes : acier inox
- Joint : NBR
- Soupape : laiton chromé

> MATIÈRE EMBOUT

- Acier inox haute résistance



SÉCURITÉ

Sécurité à la déconnexion : impossibilité de débranchement accidentel, car seule une poussée sur l'embout et simultanément un mouvement axial de la bague du raccord permettent la déconnexion de l'embout.

CONNEXION STANDARD

Connexion par simple poussée de l'embout dans le raccord. Les raccords BAC sont compatibles avec la plupart des raccords utilisés pour l'air respirable. Ce profil est installé sur la majorité des équipements de protection individuelle.

PERFORMANCES

Diamètre de passage : 7,4 mm correspondant aux débits requis pour les applications air respirable.

Les lubrifiants sans silicone utilisés au montage des raccords sont de **qualité alimentaire**.

ÉTANCHÉITÉ GARANTIE

La technologie employée, la rigueur des cotes, la précision des ajustements mécaniques assurent au couple, raccord rapide Prevost BAC et embout Prevost BAP, une **étanchéité totale**.

A l'intérieur des filetages Gaz BSP mâles cylindriques des raccords et des embouts, un cône d'étanchéité à 60° assure un montage parfait sur les flexibles Prevost BAH, sans produit d'étanchéité.

Un contrôle d'étanchéité est effectué à l'unité.

FACILITÉ DE MANIPULATION

La souplesse et la légèreté du tuyau permettent la liberté de mouvements de l'opérateur.

Le rayon de courbure réduit facilite le travail, même dans les conditions les plus difficiles.

RÉSISTANCE DU TUYAU

- Excellente résistance à l'écrasement
- Très bonne tenue à l'abrasion

RÉSISTANCE DES RACCORDEMENTS

Résistance des raccords sur l'équipement de protection. Pas de risque de débranchements accidentels.

Conformité à la norme EN 14594.

CONDITIONNEMENT

Pour mise à l'abri de la poussière, les raccords et embouts sont équipés de bouchons de protection jetable.

Les flexibles sont protégés par un sachet individuel.

CARACTÉRISTIQUES TECHNIQUES DU TUYAU

- > Tuyau PVC composé de 2 couches et d'une tresse textile
 - Tube intérieur en PVC noir assurant la fonction antistatique
 - Tresse de renfort textile
 - Robe extérieure lisse en PVC mono couche
 - Couleur bleue (RAL 5015)
- > Conforme à la norme EN 14594
- > Antistatique – Résistance électrique > 103 Ω et < 108 Ω
- > Résistant à la chaleur
- > Température d'utilisation: -20°C + 60°C
- > Décontaminable
- > Exempt de silicone

Marquage sur tuyau: année et jour de fabrication

Marquage sur douilles de sertissage: année et semaine de fabrication

Flexibles équipés prêts à l'emploi

Flexibles avec jonctions serties et écrous tournants équipés d'un raccord BAC et d'un embout BAP

Ensemble monté suivant la norme EN 14594 se composant de :







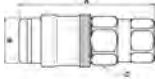

- > 1 longueur de tuyau antistatique
- > 2 jonctions serties inox 316 L avec écrou tournant inox 316 L
 - taraudage avec cône d'étanchéité 60°
 - G 1/4 et G 3/8 Gaz BSP femelle cylindrique
- > 1 embout BAP 07
- > 1 raccord BAC 07

Flexible avec jonctions serties et écrous tournants

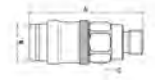

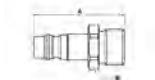
Ensemble monté suivant la norme EN 14594 se composant de :

- > 1 longueur de tuyau antistatique
- > 2 jonctions serties inox 316 L avec écrou tournant inox 316 L
 - taraudage avec cône d'étanchéité 60° (liaison sans produit d'étanchéité)
 - G 1/4 et G 3/8 Gaz BSP femelle

RACCORDS AIR RESPIRABLE BAC 07

Débit sous 6 bar 106,5 Nm ³ /h - DP = 1 b		Poids 115 gr		Pression maxi 10 bar		Diamètre 7,4 mm		Température - 20°C à + 60°C		Matière Laiton chromé	
		A	B	C	DESIGNATION				REFERENCE		
Raccord taraudé femelle											
		65	21	20	G 1/4				BAC 071101		
Raccord fileté mâle											
		62	21	20	G 1/4				BAC 071151		
		62	21	20	G 3/8				BAC 071152		
Embout fileté mâle											
		41	17		G 1/4				BAP 076151		
		42	19		G 3/8				BAP 076152		
Capuchon de protection (en option)											
					Pour raccords BAC				BAC 07CA		
Capuchon de protection (en option)											
					Pour embouts BAP				BAP 07CA		
Pièce détachée											
					Bague d'étanchéité pour raccord BAC 071151				KES 0191101		

FLEXIBLES DE LIAISON AIR RESPIRABLE - BAH

Température - 20°C à + 60 °C		Matière PVC 2 couches Tresse textile				Matière Décontaminable Exempt de silicone			
		Diamètre int./ext. en mm	Longueur en mètres	Poids g/m	Pression maxi en bar	Taraudage Gaz BSP	Rayon de courbure à 20°C	REFERENCE	
Flexibles avec raccords et embouts									
	10 x 16	2	160	10	-	40	BAH 1002CP		
	10 x 16	10	160	10	-	40	BAH 1010CP		
	10 x 16	15	160	10	-	40	BAH 1015CP		
	10 x 16	20	160	10	-	40	BAH 1020CP		
Flexibles avec jonctions serties									
	10 x 16	10	160	10	G 3/8	20	BAH 1010		
	10 x 16	15	160	10	G 3/8	40	BAH 1015		
	10 x 16	20	160	10	G 3/8	40	BAH 1020		

UNE GAMME COMPLÈTE ET PERFORMANTE

- ▶ Gamme Polymère : raccords instantanés légers, résistants et faciles à implanter
- ▶ Gamme Micro Conex : raccords instantanés à encombrement réduit
- ▶ Gamme Métal
- ▶ Gamme Inox

IMPLANTATION

- ▶ Sûreté et facilité d'implantation
- ▶ Serrage sur 6 pans intérieur/extérieur
- ▶ Filetage d'implantation conique ou cylindrique avec joint d'étanchéité
- ▶ Corps orientable sur la gamme polymère

CONNEXION

- ▶ Facilité de connexion
- ▶ Connexion par simple poussée du tube dans le raccord

DÉCONNEXION

- ▶ Souplesse de manipulation
- ▶ Déconnexion par appui sur la bague de déconnexion qui pousse les griffes et libère le tube du raccord
- ▶ Réactivité due au système auto-positionnant de la bague

ÉTANCHÉITÉ IMMÉDIATE

- ▶ Filetage conique prêtéflonné
- ▶ Filetage cylindrique joint NBR fond de gorge

MAINTIEN DU TUBE

- ▶ Excellente tenue du tube dans le raccord
- ▶ Griffes acier inox
- ▶ Excellent accrochage sur l'extérieur du tube

TENUE

- ▶ Tenue aux vibrations
- ▶ Très bonne connexion, même dans les conditions les plus sévères (vibrations, défaut d'alignement)



Facilité de mise en oeuvre

L'implantation de tous les raccords droits peut être réalisée avec une clef 6 pans facilitant le montage



Coude mâle prolongateur et orientable à 90°

Optimisation des sorties coudées
Centralisation des connexions coudées



Système de positionnement avec alignement sur oeillet



CARACTÉRISTIQUES TECHNIQUES

> Type de fluide	Air comprimé	
> Pression de service	0 à 10 bar	0 à 150 PSI
> Température d'utilisation	0 à 60°C	32 à 140°F
> Tube recommandé	Polyuréthane ou Polyamide	

SPÉCIFICATIONS

> Filetage conique	BSP	R 1/8 au R 1/2
> Filetage cylindrique	BSP	G 1/8 au G 1/2
> Filetage conique	NPT	1/8 au 1/2
> Filetage cylindrique	UNF	10 - 32
> Filetage cylindrique Métrique	Métrique	M3 et M5

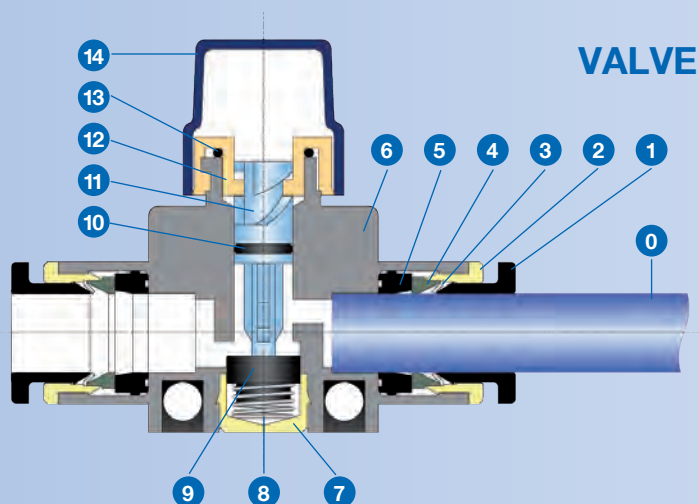

- 0 Tube
- 1 Bague de déconnexion
- 2 Chemise métallique
- 3 Griffes inox
- 4 Butée
- 5 Joint à lèvres
- 6 Corps polymère
- 7 Siège
- 8 Ressort
- 9 Joint plat épaulé
- 10 Joint torique
- 11 Boisseau pour ouverture et fermeture avec chemise pour échappement
- 12 Écrou de buse
- 13 Joint torique
- 14 Tête de vanne

RÉGLEUR DE DÉBIT

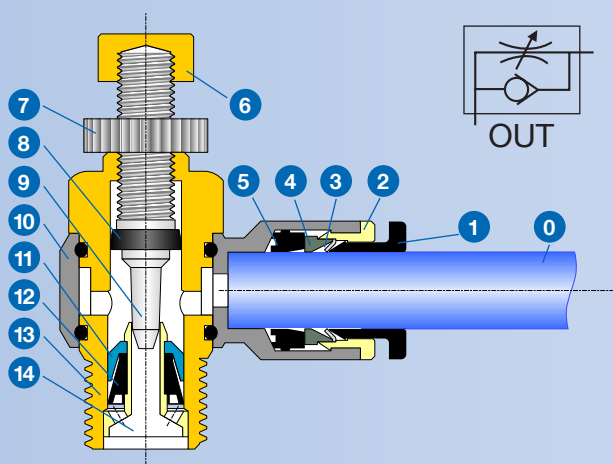

- 0 Tube
- 1 Bague de déconnexion
- 2 Chemise métallique
- 3 Griffes inox
- 4 Butée
- 5 Joint à lèvres
- 6 Molette de réglage
- 7 Écrou de blocage
- 8 Joint à lèvres
- 9 Vis pointeau
- 10 Corps polymère
- 11 Butée
- 12 Joint à lèvres
- 13 Filetage pré-téflonné
- 14 Buse

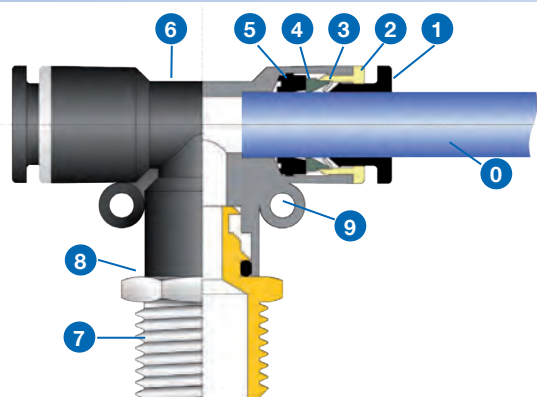



TÉ

- 0 Tube
- 1 Bague de déconnexion
- 2 Chemise métallique
- 3 Griffes inox
- 4 Butée
- 5 Joint à lèvres
- 6 Corps polymère
- 7 Filetage cylindrique avec joint en fond de gorge ou filetage conique pré-téflonné
- 8 Corps orientable
- 9 CÉillets de fixation



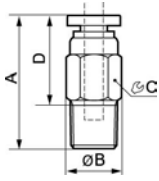

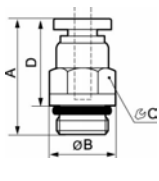
RACCORDS INSTANTANES POLYMERE

RACCORDS IMPLANTATION

Fluide Air	Diamètre Tubes: Ø ext. 4 à 16 mm	Pression 0 à 10 bar	Température 0 à 60° C		Matière Filetages : laiton nickelé			Matière polymère (raccords droits : laiton nickelé)	Compatibilité PU - PA	Etanchéité Mâle cylindrique avec joint	Etanchéité Mâle conique préfilonné
			A	B	C	D	E				
Raccord droit mâle conique - RPD MR											
							Laiton nickelé				
							Tube Ø ext.	Filetage Gaz BSP			
		21	11.5	10	13.5	4 mm	R 1/8	RPD MR0400			
		20	16	14	11	4 mm	R 1/4	RPD MR0401			
		22	14	12	14.5	5 mm	R 1/8	RPD MR0500			
		21	16	14	12	5 mm	R 1/4	RPD MR0501			
		23	19.5	17	12	5 mm	R 3/8	RPD MR0502			
		25.5	24	21	12.5	5 mm	R 1/2	RPD MR0503			
		22	14	12	14.5	6 mm	R 1/8	RPD MR0600			
		21	16	14	12	6 mm	R 1/4	RPD MR0601			
		23	19.5	17	12	6 mm	R 3/8	RPD MR0602			
		25.5	24	21	12.5	6 mm	R 1/2	RPD MR0603			
		27	16	14	19.5	8 mm	R 1/8	RPD MR0800			
		24	16	14	15	8 mm	R 1/4	RPD MR0801			
		24.5	19.5	17	13.5	8 mm	R 3/8	RPD MR0802			
		26	24	21	13	8 mm	R 1/2	RPD MR0803			
		28	19.5	17	20.5	10 mm	R 1/8	RPD MR1000			
		29	19.5	17	20	10 mm	R 1/4	RPD MR1001			
		27	19.5	17	16	10 mm	R 3/8	RPD MR1002			
		26	24	21	13	10 mm	R 1/2	RPD MR1003			
		33	22	19	24	12 mm	R 1/4	RPD MR1201			
		29.5	22	19	18.5	12 mm	R 3/8	RPD MR1202			
		27.5	24	21	8	12 mm	R 1/2	RPD MR1203			
		33.1	25	22	22.1	14 mm	R 3/8	RPD MR1402			
31.2	25	22	18.2	14 mm	R 1/2	RPD MR1403					
35	27.5	24	24	16 mm	R 3/8	RPD MR1602					
33	27.5	24	20	16 mm	R 1/2	RPD MR1603					
Raccord droit mâle cylindrique - RPD MG											
							Laiton nickelé				
							Tube Ø ext.	Filetage Gaz BSP			
		20	14	12	14.5	4 mm	G 1/8	RPD MG0400			
		19	16.5	14	13	4 mm	G 1/4	RPD MG0401			
		24	14	12	18.5	5 mm	G 1/8	RPD MG0500			
		21	16.5	14	15	5 mm	G 1/4	RPD MG0501			
		21	20	17	14.5	5 mm	G 3/8	RPD MG0502			
		22.5	22	19	14.5	5 mm	G 1/2	RPD MG0503			
		24	14	12	18.5	6 mm	G 1/8	RPD MG0600			
		21	16.5	14	15	6 mm	G 1/4	RPD MG0601			
		21	20	17	20.5	6 mm	G 3/8	RPD MG0602			
		22.5	22	19	14.5	6 mm	G 1/2	RPD MG0603			
		25.5	16.5	14	20	8 mm	G 1/8	RPD MG0800			
		22	16.5	14	16	8 mm	G 1/4	RPD MG0801			
		21	20	17	14.5	8 mm	G 3/8	RPD MG0802			
		22.5	22	19	14.5	8 mm	G 1/2	RPD MG0803			
		27.8	20	17	22.3	10 mm	G 1/8	RPD MG1000			
		27.8	20	17	21.8	10 mm	G 1/4	RPD MG1001			
		25.8	22	19	19.3	10 mm	G 3/8	RPD MG1002			
		26.3	25	21	18.3	10 mm	G 1/2	RPD MG1003			
		30	22	19	24	12 mm	G 1/4	RPD MG1201			
		26.5	22	19	20	12 mm	G 3/8	RPD MG1202			
		28	25	21	20	12 mm	G 1/2	RPD MG1203			
		30.8	25.5	22	24.3	14 mm	G 3/8	RPD MG1402			
28	28	24	20	14 mm	G 1/2	RPD MG1403					
33	28	24	26.5	16 mm	G 3/8	RPD MG1602					
34.5	28	24	26.5	16 mm	G 1/2	RPD MG1603					

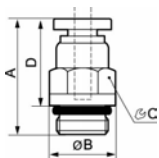

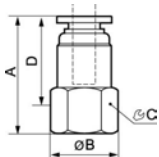
RACCORDS INSTANTANES POLYMERE

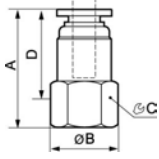
RACCORDS IMPLANTATION

Fluide Air	Diamètre Tubes: Ø ext. 4 à 16 mm	Pression 0 à 10 bar	Température 0 à 60° C	Matière Filetages : laiton nickelé					Matière polymère (raccords droits : laiton nickelé)	Compatibilité PU - PA	Etanchéité Mâle cylindrique avec joint	Etanchéité Mâle conique préfileté			
				A	B	C	D	E					DESIGNATION	REFERENCE	
Raccord droit mâle cylindrique - RPD MG															
								Laiton nickelé							
								Tube Ø ext.	Filetage métrique						
		21.5	12	10	17.5			4 mm	M5	RPD MG04M5					
		24	14	12	20			5 mm	M5	RPD MG05M5					
							24	14	12	20			6 mm	M5	RPD MG06M5
Raccord droit femelle cylindrique - RPD FG															
								Laiton nickelé							
								Tube Ø ext.	Filetage Gaz BSP						
		24	16.5	14	14			4 mm	G 1/8	RPD FG0400					
		26.5	20	17	19			4 mm	G 1/4	RPD FG0401					
		27	16.5	14	20			5 mm	G 1/8	RPD FG0500					
		26	20	17	18.5			5 mm	G 1/4	RPD FG0501					
		28.5	22	19	20.5			5 mm	G 3/8	RPD FG0502					
		31	28	24	21			5 mm	G 1/2	RPD FG0503					
		27	16.5	14	20			6 mm	G 1/8	RPD FG0600					
		26	20	17	18.5			6 mm	G 1/4	RPD FG0601					
		28.5	22	19	20.5			6 mm	G 3/8	RPD FG0602					
		31	28	24	21			6 mm	G 1/2	RPD FG0603					
		28	20	17	21			8 mm	G 1/8	RPD FG0800					
		28	20	17	20.5			8 mm	G 1/4	RPD FG0801					
		28.5	22	19	20.5			8 mm	G 3/8	RPD FG0802					
		31	28	24	21			8 mm	G 1/2	RPD FG0803					
		29.5	22	19	22.5			10 mm	G 1/8	RPD FG1000					
		29.5	22	19	22			10 mm	G 1/4	RPD FG1001					
		32	24.5	21	24			10 mm	G 3/8	RPD FG1002					
		32	28	24	22			10 mm	G 1/2	RPD FG1003					
		31.5	24.5	21	24			12 mm	G 1/4	RPD FG1201					
33	24.5	21	25			12 mm	G 3/8	RPD FG1202							
33	28	24	23			12 mm	G 1/2	RPD FG1203							
31.3	28	24	23.3			14 mm	G 3/8	RPD FG1402							
32	28	24	22			14 mm	G 1/2	RPD FG1403							
34	28	24	26			16 mm	G 3/8	RPD FG1602							
35	28	24	25			16 mm	G 1/2	RPD FG1603							
Raccord droit femelle cylindrique - RPD FG															
								Laiton nickelé							
								Tube Ø ext	Filetage métrique						
		22	14	12	17			4 mm	M5	RPD FG04M5					
		23.5	16.5	14	18.5			5 mm	M5	RPD FG05M5					
							23.5	16.5	14	18.5			6 mm	M5	RPD FG06M5

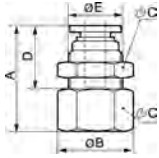

RACCORDS INSTANTANES POLYMERE

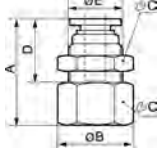
RACCORDS IMPLANTATION

Fluide Air	Diamètre Tubes: Ø ext. 4 à 16 mm	Pression 0 à 10 bar	Température 0 à 60° C		Matière Filetages : laiton nickelé			Matière polymère (raccords droits : laiton nickelé)	Compatibilité PU - PA	Étanchéité Mâle cylindrique avec joint	Étanchéité Mâle conique préflonné
			A	B	C	D	E				
Raccord droit traversée de cloison femelle cylindrique - RPD TG											
								Laiton nickelé			
								Tube Ø ext.	Filetage Gaz BSP		
		24.5	16.5	14	15.5	10	4 mm	G 1/8	RPD TG0400		
		26	20	17	17	10	4 mm	G 1/4	RPD TG0401		
		27	20	17	18.5	12.8	5 mm	G 1/8	RPD TG0500		
		28	20	17	18.5	12.8	5 mm	G 1/4	RPD TG0501		
		29.5	22	19	19.5	12.8	5 mm	G 3/8	RPD TG0502		
		31	28	24	19	12.8	5 mm	G 1/2	RPD TG0503		
		27	20	17	18.5	12.8	6 mm	G 1/8	RPD TG0600		
		28	20	17	18.5	12.8	6 mm	G 1/4	RPD TG0601		
		29.5	22	19	19.5	12.8	6 mm	G 3/8	RPD TG0602		
		31	28	24	19	12.8	6 mm	G 1/2	RPD TG0603		
		26.5	20	17	17.5	13.8	8 mm	G 1/8	RPD TG0800		
		28	20	17	18.5	13.8	8 mm	G 1/4	RPD TG0801		
		29	22	19	19	13.8	8 mm	G 3/8	RPD TG0802		
		31.5	28	24	19.5	13.8	8 mm	G 1/2	RPD TG0803		
		29.5	24.5	21	21	16.8	10 mm	G 1/8	RPD TG1000		
		29.5	24.5	21	20	16.8	10 mm	G 1/4	RPD TG1001		
		31.5	24.5	21	21.5	16.8	10 mm	G 3/8	RPD TG1002		
		31.5	28	24	19.5	16.8	10 mm	G 1/2	RPD TG1003		
		32	28	24	22.5	19.8	12 mm	G 1/4	RPD TG1201		
		33	28	24	23	19.8	12 mm	G 3/8	RPD TG1202		
		33	28	24	21	19.8	12 mm	G 1/2	RPD TG1203		
		32.5	28	24	22.5	22.7	14 mm	G 3/8	RPD TG1402		
34.5	28	24	22.5	22.7	14 mm	G 1/2	RPD TG1403				
32.3	28	24	22.3	23.8	16 mm	G 3/8	RPD TG1602				
34.3	28	24	22.3	23.8	16 mm	G 1/2	RPD TG1603				
Raccord droit traversée de cloison femelle cylindrique - RPD TG											
								Laiton nickelé			
								Tube Ø ext.	Filetage métrique		
		22	16.5	14	15	10	4 mm	M5	RPD TG04M5		
		23	16.5	14	16	12.8	5 mm	M5	RPD TG05M5		
23	16.5	14	16	12.8	6 mm	M5	RPD TG06M5				

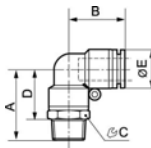

RACCORDS INSTANTANES POLYMERE

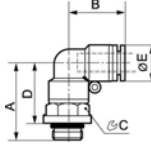
RACCORDS IMPLANTATION

Fluide Air	Diamètre Tubes: Ø ext. 4 à 16 mm	Pression 0 à 10 bar	Température 0 à 60° C		Matière Filetages : laiton nickelé		Matière polymère (raccords droits : laiton nickelé)	Compatibilité PU - PA	Etanchéité Mâle cylindrique avec joint	Etanchéité Mâle conique préflonné	
			A	B	C	D					E
Coude 90° mâle conique orientable - RPC MR											
							Tube Ø ext.	Filetage Gaz BSP			
		25	17.5	10	17.5	10	4 mm	R 1/8	RPC MR0400		
		26.5	17.5	14	17.5	10	4 mm	R 1/4	RPC MR0401		
		27.5	20.5	12	20	12.8	5 mm	R 1/8	RPC MR0500		
		29	20.5	14	20	12.8	5 mm	R 1/4	RPC MR0501		
		31.5	20.5	17	20.5	12.8	5 mm	R 3/8	RPC MR0502		
		34	20.5	21	21	12.8	5 mm	R 1/2	RPC MR0503		
		27.5	20.5	12	20	12.8	6 mm	R 1/8	RPC MR0600		
		29	20.5	14	20	12.8	6 mm	R 1/4	RPC MR0601		
		31.5	20.5	17	20.5	12.8	6 mm	R 3/8	RPC MR0602		
		34	20.5	21	21	12.8	6 mm	R 1/2	RPC MR0603		
		29.5	22.5	14	22	13.8	8 mm	R 1/8	RPC MR0800		
		31	22.5	14	22	13.8	8 mm	R 1/4	RPC MR0801		
		33.5	22.5	17	22.5	13.8	8 mm	R 3/8	RPC MR0802		
		36	22.5	21	23	13.8	8 mm	R 1/2	RPC MR0803		
		33.2	26.3	17	25.7	16.8	10 mm	R 1/8	RPC MR1000		
		34.7	26.3	17	25.7	16.8	10 mm	R 1/4	RPC MR1001		
		36.7	26.3	17	25.7	16.8	10 mm	R 3/8	RPC MR1002		
		39.2	26.3	21	26.2	16.8	10 mm	R 1/2	RPC MR1003		
		35.5	27.8	19	26.5	19.8	12 mm	R 1/4	RPC MR1201		
		38	27.8	19	27	19.8	12 mm	R 3/8	RPC MR1202		
		40	27.8	21	27	19.8	12 mm	R 1/2	RPC MR1203		
		40	29.8	22	29	22.7	14 mm	R 3/8	RPC MR1402		
		42	29.8	22	29	22.7	14 mm	R 1/2	RPC MR1403		
41.5	30.8	24	30.5	23.8	16 mm	R 3/8	RPC MR1602				
43.5	30.8	24	30.5	23.8	16 mm	R 1/2	RPC MR1603				
Coude 90° mâle cylindrique orientable - RPC MG											
							Tube Ø ext.	Filetage Gaz BSP			
		24.1	17.5	12	18.6	10	4 mm	G 1/8	RPC MG0400		
		24.7	17.5	14	18.7	10	4 mm	G 1/4	RPC MG0401		
		27	20.5	12	21.5	12.8	5 mm	G 1/8	RPC MG0500		
		27.5	20.5	14	21.5	12.8	5 mm	G 1/4	RPC MG0501		
		29	20.5	17	22.5	12.8	5 mm	G 3/8	RPC MG0502		
		30	20.5	21	22	12.8	5 mm	G 1/2	RPC MG0503		
		27	20.5	12	21.5	12.8	6 mm	G 1/8	RPC MG0600		
		27.5	20.5	14	21.5	12.8	6 mm	G 1/4	RPC MG0601		
		29	20.5	17	22.5	12.8	6 mm	G 3/8	RPC MG0602		
		30	20.5	21	22	12.8	6 mm	G 1/2	RPC MG0603		
		29.2	22.5	14	23.7	13.8	8 mm	G 1/8	RPC MG0800		
		29.2	22.5	14	23.2	13.8	8 mm	G 1/4	RPC MG0801		
		30.7	22.5	17	24.2	13.8	8 mm	G 3/8	RPC MG0802		
		31.7	22.5	21	23.7	13.8	8 mm	G 1/2	RPC MG0803		
		33.7	26.3	17	28.2	16.8	10 mm	G 1/8	RPC MG1000		
		34.2	26.3	17	28.2	16.8	10 mm	G 1/4	RPC MG1001		
		34.2	26.3	17	27.7	16.8	10 mm	G 3/8	RPC MG1002		
		35.2	26.3	21	27.2	16.8	10 mm	G 1/2	RPC MG1003		
		35	27.8	19	29	19.8	12 mm	G 1/4	RPC MG1201		
		34.5	27.8	19	28	19.8	12 mm	G 3/8	RPC MG1202		
		36	27.8	21	28	19.8	12 mm	G 1/2	RPC MG1203		
		38.2	29.8	22	31.7	22.7	14 mm	G 3/8	RPC MG1402		
		37.2	29.8	24	29.2	22.7	14 mm	G 1/2	RPC MG1403		
41.5	30.8	24	34.9	23.8	16 mm	G 3/8	RPC MG1602				
39	30.8	24	31	23.8	16 mm	G 1/2	RPC MG1603				

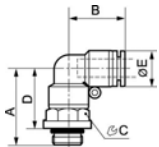

RACCORDS INSTANTANES POLYMERE

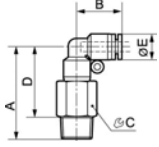
RACCORDS IMPLANTATION

Fluide Air	Diamètre Tubes: Ø ext. 4 à 16 mm	Pression 0 à 10 bar	Température 0 à 60° C		Matière Filetages : laiton nickelé			Matière polymère (raccords droits : laiton nickelé)	Compatibilité PU - PA	Etanchéité Mâle cylindrique avec joint	Etanchéité Mâle conique préflonné
			A	B	C	D	E				
Coude 90° mâle cylindrique orientable - RPC MG											
		25	17.5	10	21	10	Tube Ø ext. 4 mm	Filetage métrique M5	RPC MG04M5		
		27.5	20.5	12	23.5	12.8	6 mm	M5	RPC MG06M5		
		27.5	20.5	12	23.5	12.8	5 mm	M5	RPC MG05M5		
Coude 90° mâle conique long orientable - RPC LR											
		35.5	17.5	10	28	10	Tube Ø ext. 4 mm	Filetage Gaz BSP R 1/8	RPC LR0400		
		37	17.5	14	28	10	4 mm	R 1/4	RPC LR0401		
		40.5	20.5	12	33	12.8	5 mm	R 1/8	RPC LR0500		
		43.5	20.5	14	34.5	12.8	5 mm	R 1/4	RPC LR0501		
		46	20.5	17	35	12.8	5 mm	R 3/8	RPC LR0502		
		48.5	20.5	21	35.5	12.8	5 mm	R 1/2	RPC LR0503		
		40.5	20.5	12	33	12.8	6 mm	R 1/8	RPC LR0600		
		43.5	20.5	14	34.5	12.8	6 mm	R 1/4	RPC LR0601		
		46	20.5	17	35	12.8	6 mm	R 3/8	RPC LR0602		
		48.5	20.5	21	35.5	12.8	6 mm	R 1/2	RPC LR0603		
		44	22.5	14	36.5	13.8	8 mm	R 1/8	RPC LR0800		
		45.5	22.5	14	36.5	13.8	8 mm	R 1/4	RPC LR0801		
		48	22.5	17	37	13.8	8 mm	R 3/8	RPC LR0802		
		50.5	22.5	21	37.5	13.8	8 mm	R 1/2	RPC LR0803		
		51.2	26.3	17	43.7	16.8	10 mm	R 1/8	RPC LR1000		
		52.7	26.3	17	43.7	16.8	10 mm	R 1/4	RPC LR1001		
		54.7	26.3	17	43.7	16.8	10 mm	R 3/8	RPC LR1002		
		57.2	26.3	21	44.2	16.8	10 mm	R 1/2	RPC LR1003		
		55.5	27.8	19	46.5	19.8	12 mm	R 1/4	RPC LR1201		
		58	27.8	19	47	19.8	12 mm	R 3/8	RPC LR1202		
		60	27.8	21	47	19.8	12 mm	R 1/2	RPC LR1203		
		60.5	29.8	22	49.5	22.7	14 mm	R 3/8	RPC LR1402		
62.5	29.8	22	49.5	22.7	14 mm	R 1/2	RPC LR1403				
62	30.8	24	51	23.8	16 mm	R 3/8	RPC LR1602				
64	30.8	24	51	23.8	16 mm	R 1/2	RPC LR1603				

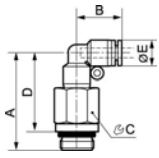

RACCORDS INSTANTANES POLYMERE

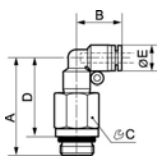
RACCORDS IMPLANTATION

Fluide Air	Diamètre Tubes: Ø ext. 4 à 16 mm	Pression 0 à 10 bar	Température 0 à 60° C		Matière Filetages : laiton nickelé			Matière polymère (raccords droits : laiton nickelé)	Compatibilité PU - PA	Etanchéité Mâle cylindrique avec joint	Etanchéité Mâle conique préflonné
			A	B	C	D	E				
Coude 90° mâle cylindrique long orientable - RPC LG											
							Tube Ø ext.	Filetage Gaz BSP			
		34.5	17.5	14	29	10	4 mm	G 1/8	RPC LG0400		
		35	17.5	17	29	10	4 mm	G 1/4	RPC LG0401		
		40	20.5	14	34.5	12.8	5 mm	G 1/8	RPC LG0500		
		42	20.5	17	36	12.8	5 mm	G 1/4	RPC LG0501		
		43.5	20.5	21	37	12.8	5 mm	G 3/8	RPC LG0502		
		44.5	20.5	24	36.5	12.8	5 mm	G 1/2	RPC LG0503		
		40	20.5	14	34.5	12.8	6 mm	G 1/8	RPC LG0600		
		42	20.5	17	36	12.8	6 mm	G 1/4	RPC LG0601		
		43.5	20.5	21	37	12.8	6 mm	G 3/8	RPC LG0602		
		44.5	20.5	24	36.5	12.8	6 mm	G 1/2	RPC LG0603		
		44	22.5	14	38.5	13.8	8 mm	G 1/8	RPC LG0800		
		44	22.5	14	38	13.8	8 mm	G 1/4	RPC LG0801		
		45.5	22.5	17	39	13.8	8 mm	G 3/8	RPC LG0802		
		46.5	22.5	24	38.5	13.8	8 mm	G 1/2	RPC LG0803		
		51.7	26.3	17	46.2	16.8	10 mm	G 1/8	RPC LG1000		
		52.2	26.3	17	46.2	16.8	10 mm	G 1/4	RPC LG1001		
		52.2	26.3	21	45.7	16.8	10 mm	G 3/8	RPC LG1002		
		53.2	26.3	24	45.2	16.8	10 mm	G 1/2	RPC LG1003		
		55	27.8	19	49	19.8	12 mm	G 1/4	RPC LG1201		
		54.5	27.8	21	48	19.8	12 mm	G 3/8	RPC LG1202		
56	27.8	24	48	19.8	12 mm	G 1/2	RPC LG1203				
57	29.8	24	50.5	22.7	14 mm	G 3/8	RPC LG1402				
58.5	29.8	24	50.5	22.7	14 mm	G 1/2	RPC LG1403				
58.5	30.8	24	52	23.8	16 mm	G 3/8	RPC LG1602				
60	30.8	24	52	23.8	16 mm	G 1/2	RPC LG1603				
Coude 90° mâle cylindrique long orientable - RPC LG											
							Tube Ø ext.	Filetage métrique			
		35.5	17.5	10	31.5	10	4 mm	M5	RPC LG04M5		
		40.5	20.5	12	36.5	12.8	5 mm	M5	RPC LG05M5		
	40.5	20.5	12	36.5	12.8	6 mm	M5	RPC LG06M5			

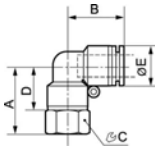

RACCORDS INSTANTANES POLYMERE

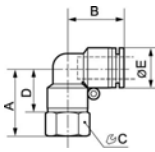
RACCORDS IMPLANTATION

Fluide Air	Diamètre Tubes: Ø ext. 4 à 16 mm	Pression 0 à 10 bar	Température 0 à 60° C		Matière Filetages : laiton nickelé			Matière polymère (raccords droits : laiton nickelé)	Compatibilité PU - PA	Etanchéité Mâle cylindrique avec joint	Etanchéité Mâle conique préflonné
			A	B	C	D	E				
Coude 90° femelle cylindrique orientable - RPC FG											
		22.5	17.5	12	15.5	10	Tube Ø ext. 4 mm	Filetage Gaz BSP G 1/8	RPC FG0400		
		23	17.5	17	15.5	10	4 mm	G 1/4	RPC FG0401		
		25	20.5	12	18	12.8	5 mm	G 1/8	RPC FG0500		
		25.5	20.5	17	18	12.8	5 mm	G 1/4	RPC FG0501		
		26	20.5	19	18	12.8	5 mm	G 3/8	RPC FG0502		
		28	20.5	24	18	12.8	5 mm	G 1/2	RPC FG0503		
		25	20.5	12	18	12.8	6 mm	G 1/8	RPC FG0600		
		25.5	20.5	17	18	12.8	6 mm	G 1/4	RPC FG0601		
		26	20.5	19	18	12.8	6 mm	G 3/8	RPC FG0602		
		28	20.5	24	18	12.8	6 mm	G 1/2	RPC FG0603		
		26.7	22.5	14	19.7	13.8	8 mm	G 1/8	RPC FG0800		
		27.2	22.5	17	19.7	13.8	8 mm	G 1/4	RPC FG0801		
		27.7	22.5	19	19.7	13.8	8 mm	G 3/8	RPC FG0802		
		29.7	22.5	24	19.7	13.8	8 mm	G 1/2	RPC FG0803		
		30.2	26.3	19	23.2	16.8	10 mm	G 1/8	RPC FG1000		
		30.7	26.3	19	23.2	16.8	10 mm	G 1/4	RPC FG1001		
		31.2	26.3	19	23.2	16.8	10 mm	G 3/8	RPC FG1002		
		33.2	26.3	24	23.2	16.8	10 mm	G 1/2	RPC FG1003		
		31.5	27.8	19	24	19.8	12 mm	G 1/4	RPC FG1201		
		32	27.8	21	24	19.8	12 mm	G 3/8	RPC FG1202		
		34	27.8	24	24	19.8	12 mm	G 1/2	RPC FG1203		
		33.5	29.8	22	25.5	22.7	14 mm	G 3/8	RPC FG1402		
		35.5	29.8	24	25.5	22.7	14 mm	G 1/2	RPC FG1403		
		35	30.8	24	27	23.8	16 mm	G 3/8	RPC FG1602		
		37	30.8	24	27	23.8	16 mm	G 1/2	RPC FG1603		
Coude 90° femelle cylindrique orientable - RPC FG											
		20.5	17.5	12	15.5	10	Tube Ø ext. 4 mm	Filetage métrique M5	RPC FG04M5		
		23	20.5	12	18	12.8	5 mm	M5	RPC FG05M5		
		23	20.5	12	18	12.8	6 mm	M5	RPC FG06M5		

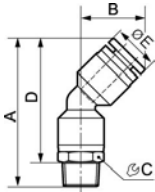

RACCORDS INSTANTANES POLYMERE

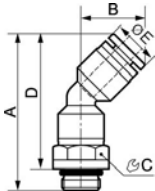
RACCORDS IMPLANTATION

Fluide Air	Diamètre Tubes: Ø ext. 4 à 16 mm	Pression 0 à 10 bar	Température 0 à 60° C		Matière Filetages : laiton nickelé			Matière polymère (raccords droits : laiton nickelé)	Compatibilité PU - PA	Étanchéité Mâle cylindrique avec joint	Étanchéité Mâle conique préflonné
			A	B	C	D	E				
Coude 45° mâle conique orientable - RPQ MR											
								Tube Ø ext.	Filetage Gaz BSP		
		39.4	14.5	10	31.9	10	4 mm	R 1/8	RPQ MR0400		
		40.9	14.5	14	31.9	10	4 mm	R 1/4	RPQ MR0401		
		43	16.5	12	35.5	12.8	5 mm	R 1/8	RPQ MR0500		
		44.5	16.5	14	35.5	12.8	5 mm	R 1/4	RPQ MR0501		
		47	16.5	17	36	12.8	5 mm	R 3/8	RPQ MR0502		
		49.5	16.5	21	36.5	12.8	5 mm	R 1/2	RPQ MR0503		
		43	16.5	12	35.5	12.8	6 mm	R 1/8	RPQ MR0600		
		44.5	16.5	14	35.5	12.8	6 mm	R 1/4	RPQ MR0601		
		47	16.5	17	36	12.8	6 mm	R 3/8	RPQ MR0602		
		49.5	16.5	21	36.5	12.8	6 mm	R 1/2	RPQ MR0603		
		46	19	14	38.5	13.8	8 mm	R 1/8	RPQ MR0800		
		47.5	19	14	38.5	13.8	8 mm	R 1/4	RPQ MR0801		
		50	19	17	39	13.8	8 mm	R 3/8	RPQ MR0802		
		52.5	19	21	39.5	13.8	8 mm	R 1/2	RPQ MR0803		
		51.3	22	17	43.8	16.8	10 mm	R 1/8	RPQ MR1000		
		52.8	22	17	43.8	16.8	10 mm	R 1/4	RPQ MR1001		
		54.8	22	17	43.8	16.8	10 mm	R 3/8	RPQ MR1002		
		57.3	22	21	44.3	16.8	10 mm	R 1/2	RPQ MR1003		
		55.5	23	19	46.5	19.8	12 mm	R 1/4	RPQ MR1201		
58	23	19	47	19.8	12 mm	R 3/8	RPQ MR1202				
60	23	21	47	19.8	12 mm	R 1/2	RPQ MR1203				
Coude 45° mâle cylindrique orientable - RPQ MG											
								Tube Ø ext.	Filetage Gaz BSP		
		38	14.5	12	33.5	10	4 mm	G 1/8	RPQ MG0400		
		39	14.5	14	33	10	4 mm	G 1/4	RPQ MG0401		
		41.5	16.5	12	35.5	12.8	5 mm	G 1/8	RPQ MG0500		
		42.5	16.5	14	36.5	12.8	5 mm	G 1/4	RPQ MG0501		
		44	16.5	17	37.5	12.8	5 mm	G 3/8	RPQ MG0502		
		44	16.5	21	36	12.8	5 mm	G 1/2	RPQ MG0503		
		42	16.5	12	35.5	12.8	6 mm	G 1/8	RPQ MG0600		
		43	16.5	14	37	12.8	6 mm	G 1/4	RPQ MG0601		
		44	16.5	17	37.5	12.8	6 mm	G 3/8	RPQ MG0602		
		45	16.5	21	37	12.8	6 mm	G 1/2	RPQ MG0603		
		46	19	14	40.5	13.8	8 mm	G 1/8	RPQ MG0800		
		46	19	14	40	13.8	8 mm	G 1/4	RPQ MG0801		
		47	19	17	40	13.8	8 mm	G 3/8	RPQ MG0802		
		48.5	19	21	40.5	13.8	8 mm	G 1/2	RPQ MG0803		
		51	22	17	45	16.8	10 mm	G 1/8	RPQ MG1000		
		51	22	17	45	16.8	10 mm	G 1/4	RPQ MG1001		
		51	22	17	44.5	16.8	10 mm	G 3/8	RPQ MG1002		
		52	22	21	44	16.8	10 mm	G 1/2	RPQ MG1003		
		55	23	19	49	19.8	12 mm	G 1/4	RPQ MG1201		
55	23	19	48.5	19.8	12 mm	G 3/8	RPQ MG1202				
56	23	21	48	19.8	12 mm	G 1/2	RPQ MG1203				

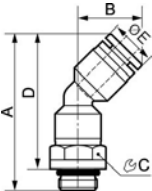

RACCORDS INSTANTANES POLYMERE

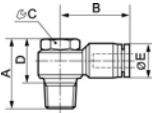
RACCORDS IMPLANTATION

Fluide Air	Diamètre Tubes: Ø ext. 4 à 16 mm	Pression 0 à 10 bar	Température 0 à 60° C		Matière Filetages : laiton nickelé		Matière polymère (raccords droits : laiton nickelé)	Compatibilité PU - PA	Etanchéité Mâle cylindrique avec joint	Etanchéité Mâle conique préfilonné
			A	B	C	D				
Coude 45° mâle cylindrique orientable - RPQ MG										
							Tube Ø ext.	Filetage métrique		
		39	14.5	10	35	10	4 mm	M5	RPQ MG04M5	
		43	16.5	12	39	12.8	5 mm	M5	RPQ MG05M5	
		42.5	16.5	12	38.5	12.8	6 mm	M5	RPQ MG06M5	
Banjo mâle conique orientable - RPB MR										
							Tube Ø ext.	Filetage Gaz BSP		
		25	21.8	10	17.5	10	4 mm	R 1/8	RPB MR0400	
		29	24	14	20	10	4 mm	R 1/4	RPB MR0401	
		25	23	10	17.5	12.8	5 mm	R 1/8	RPB MR0500	
		29	25.5	14	20	12.8	5 mm	R 1/4	RPB MR0501	
		35	27.1	19	24	12.8	5 mm	R 3/8	RPB MR0502	
		40	30.1	24	27	12.8	5 mm	R 1/2	RPB MR0503	
		25	23	10	17.5	12.8	6 mm	R 1/8	RPB MR0600	
		29	25.5	14	20	12.8	6 mm	R 1/4	RPB MR0601	
		35	27.1	19	24	12.8	6 mm	R 3/8	RPB MR0602	
		40	30.1	24	27	12.8	6 mm	R 1/2	RPB MR0603	
		25	24.6	10	17.5	13.8	8 mm	R 1/8	RPB MR0800	
		29	26.8	14	20	13.8	8 mm	R 1/4	RPB MR0801	
		35	28.8	19	24	13.8	8 mm	R 3/8	RPB MR0802	
		40	30.5	24	27	13.8	8 mm	R 1/2	RPB MR0803	
		25	28.5	10	17.5	16.8	10 mm	R 1/8	RPB MR1000	
		29	31	14	20	16.8	10 mm	R 1/4	RPB MR1001	
		35	31	19	24	16.8	10 mm	R 3/8	RPB MR1002	
		40	34	24	27	16.8	10 mm	R 1/2	RPB MR1003	
		29	31.8	14	20	19.8	12 mm	R 1/4	RPB MR1201	
		35	34	19	24	19.8	12 mm	R 3/8	RPB MR1202	
40	35.8	24	27	19.8	12 mm	R 1/2	RPB MR1203			
35	34.8	19	24	23.8	16 mm	R 3/8	RPB MR1602			
40	36.6	24	27	23.8	16 mm	R 1/2	RPB MR1603			

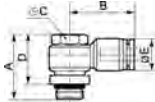

RACCORDS INSTANTANES POLYMERE

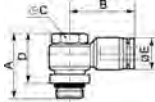
RACCORDS IMPLANTATION

Fluide Air	Diamètre Tubes: Ø ext. 4 à 16 mm	Pression 0 à 10 bar	Température 0 à 60° C		Matière Filetages : laiton nickelé			Matière polymère (raccords droits : laiton nickelé)	Compatibilité PU - PA	Etanchéité Mâle cylindrique avec joint	Etanchéité Mâle conique préflonné
			A	B	C	D	E				
Banjo mâle cylindrique orientable - RPB MG											
							Tube Ø ext.	Filetage Gaz BSP			
		23.5	23.5	10	18	10	4 mm	G 1/8	RPB MG0400		
		28	28	14	22	10	4 mm	G 1/4	RPB MG0401		
		23.5	23.5	10	18	12.8	5 mm	G 1/8	RPB MG0500		
		28	28	14	22	12.8	5 mm	G 1/4	RPB MG0501		
		34	34	19	27.5	12.8	5 mm	G 3/8	RPB MG0502		
		38	38	24	30	12.8	5 mm	G 1/2	RPB MG0503		
		23.5	23.5	10	18	12.8	6 mm	G 1/8	RPB MG0600		
		28	28	14	22	12.8	6 mm	G 1/4	RPB MG0601		
		34	34	19	27.5	12.8	6 mm	G 3/8	RPB MG0602		
		38	38	24	30	12.8	6 mm	G 1/2	RPB MG0603		
		23.5	24.6	10	18	13.8	8 mm	G 1/8	RPB MG0800		
		28	26.8	14	22	13.8	8 mm	G 1/4	RPB MG0801		
		34	28.8	19	27.5	13.8	8 mm	G 3/8	RPB MG0802		
		38	30.5	24	30	13.8	8 mm	G 1/2	RPB MG0803		
		23.5	28.5	10	18	16.8	10 mm	G 1/8	RPB MG1000		
		28	31	14	22	16.8	10 mm	G 1/4	RPB MG1001		
		34	31	19	27.5	16.8	10 mm	G 3/8	RPB MG1002		
		38	34	24	30	16.8	10 mm	G 1/2	RPB MG1003		
		28	32	14	22	19.8	12 mm	G 1/4	RPB MG1201		
34	34	19	27.5	19.8	12 mm	G 3/8	RPB MG1202				
38	36	24	30	19.8	12 mm	G 1/2	RPB MG1203				
34	34.8	19	27.5	23.8	16 mm	G 3/8	RPB MG1602				
38	36.6	24	30	23.8	16 mm	G 1/2	RPB MG1603				
Banjo mâle cylindrique orientable - RPB MG											
							Tube Ø ext.	Filetage métrique			
		20	19.7	8	16	10	4 mm	M5	RPB MG04M5		
		20	19.7	8	16	12.8	5 mm	M5	RPB MG05M5		
		20	19.7	8	16	12.8	6 mm	M5	RPB MG06M5		

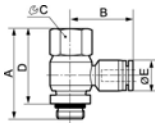

RACCORDS INSTANTANES POLYMERE

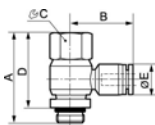
RACCORDS IMPLANTATION

Fluide Air	Diamètre Tubes: Ø ext. 4 à 16 mm	Pression 0 à 10 bar	Température 0 à 60° C		Matière Filetages : laiton nickelé			Matière polymère (raccords droits : laiton nickelé)	Compatibilité PU - PA	Etanchéité Mâle cylindrique avec joint	Etanchéité Mâle conique préflonné
			A	B	C	D	E				
Banjo femelle cylindrique orientable - RPB FG											
		30	23.5	12	24.5	10	Tube Ø ext. 4 mm	Filetage Gaz BSP G 1/8	RPB FG0400		
		32	24	17	26	10	4 mm	G 1/4	RPB FG0401		
		30	23.5	12	24.5	12.8	5 mm	G 1/8	RPB FG0500		
		32	25	17	26	12.8	5 mm	G 1/4	RPB FG0501		
		39	26.5	19	32.5	12.8	5 mm	G 3/8	RPB FG0502		
		42	29.5	24	34	12.8	5 mm	G 1/2	RPB FG0503		
		30	23	12	24.5	12.8	6 mm	G 1/8	RPB FG0600		
		32	25	17	26	12.8	6 mm	G 1/4	RPB FG0601		
		39	26.5	19	32.5	12.8	6 mm	G 3/8	RPB FG0602		
		42	29.8	24	34	12.8	6 mm	G 1/2	RPB FG0603		
		30	25	12	24.5	13.8	8 mm	G 1/8	RPB FG0800		
		32	27	17	26	13.8	8 mm	G 1/4	RPB FG0801		
		39	29	19	32.5	13.8	8 mm	G 3/8	RPB FG0802		
		42	30.3	24	34	13.8	8 mm	G 1/2	RPB FG0803		
		30	29	12	24.5	16.8	10 mm	G 1/8	RPB FG1000		
		32	33	17	26	16.8	10 mm	G 1/4	RPB FG1001		
		39	32	19	32.5	16.8	10 mm	G 3/8	RPB FG1002		
		42	34	24	34	16.8	10 mm	G 1/2	RPB FG1003		
		32	31	17	26	19.8	12 mm	G 1/4	RPB FG1201		
		39	34	19	32.5	19.8	12 mm	G 3/8	RPB FG1202		
42	36	24	34	19.8	12 mm	G 1/2	RPB FG1203				
39	34	19	32.5	23.8	16 mm	G 3/8	RPB FG1602				
42	36.3	24	34	23.8	16 mm	G 1/2	RPB FG1603				
Banjo femelle cylindrique orientable - RPB FG											
		20	19.7	8	16	10	Tube Ø ext. 4 mm	Filetage métrique M5	RPB FG04M5		
		20	22.3	10	16	12.8	5 mm	M5	RPB FG05M5		
		20	22.3	8	16	12.8	6 mm	M5	RPB FG06M5		

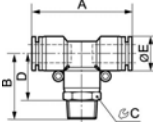

RACCORDS INSTANTANES POLYMERE

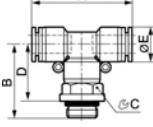
RACCORDS IMPLANTATION

Fluide Air	Diamètre Tubes: Ø ext. 4 à 16 mm	Pression 0 à 10 bar	Température 0 à 60° C		Matière Filetages : laiton nickelé		Matière polymère (raccords droits : laiton nickelé)	Compatibilité PU - PA	Etanchéité Mâle cylindrique avec joint	Etanchéité Mâle conique préflonné
			A	B	C	D				
Té mâle conique au centre orientable - RPT CR										
							Tube Ø ext.	Filetage Gaz BSP		
		35	25	10	17.5	10	4 mm	R 1/8	RPT CR0400	
		35	26.5	14	17.5	10	4 mm	R 1/4	RPT CR0401	
		41	27.5	12	20	12.8	5 mm	R 1/8	RPT CR0500	
		41	29	14	20	12.8	5 mm	R 1/4	RPT CR0501	
		41	31.5	17	20.5	18.8	5 mm	R 3/8	RPT CR0502	
		41	34	21	21	12.8	5 mm	R 1/2	RPT CR0503	
		41	27.5	12	20	12.8	6 mm	R 1/8	RPT CR0600	
		41	29	14	20	12.8	6 mm	R 1/4	RPT CR0601	
		41	31.5	17	20.5	12.8	6 mm	R 3/8	RPT CR0602	
		41	34	21	21	12.8	6 mm	R 1/2	RPT CR0603	
		45	29.5	14	22	13.8	8 mm	R 1/8	RPT CR0800	
		45	31	14	22	13.8	8 mm	R 1/4	RPT CR0801	
		45	33.5	17	22.5	13.8	8 mm	R 3/8	RPT CR0802	
		45	36	21	23	13.8	8 mm	R 1/2	RPT CR0803	
		52.6	33.2	17	25.7	16.8	10 mm	R 1/8	RPT CR1000	
		52.6	34.7	17	25.7	16.8	10 mm	R 1/4	RPT CR1001	
		52.6	36.7	17	25.7	16.8	10 mm	R 3/8	RPT CR1002	
		52.6	39.2	21	26.2	16.8	10 mm	R 1/2	RPT CR1003	
		55.6	35.5	19	26.5	19.8	12 mm	R 1/4	RPT CR1201	
		55.6	38	19	27	19.8	12 mm	R 3/8	RPT CR1202	
		55.6	40	21	27	19.8	12 mm	R 1/2	RPT CR1203	
		62	41.2	22	30.2	22.7	14 mm	R 3/8	RPT CR1402	
		62	43.2	22	30.2	22.7	14 mm	R 1/2	RPT CR1403	
64.6	43	24	32	23.8	16 mm	R 3/8	RPT CR1602			
64.6	45	24	32	23.8	16 mm	R 1/2	RPT CR1603			
Té mâle cylindrique au centre orientable - RPT CG										
							Tube Ø ext.	Filetage gaz BSP		
		35	23.6	12	18.1	10	4 mm	G 1/8	RPT CG0400	
		35	24	14	18	10	4 mm	G 1/4	RPT CG0401	
		41	27	12	21.5	12.8	5 mm	G 1/8	RPT CG0500	
		41	27.5	14	21.5	12.8	5 mm	G 1/4	RPT CG0501	
		41	29	17	22.5	12.8	5 mm	G 3/8	RPT CG0502	
		41	30	21	22	12.8	5 mm	G 1/2	RPT CG0503	
		41	27	12	21.5	12.8	6 mm	G 1/8	RPT CG0600	
		41	27.5	14	21.5	12.8	6 mm	G 1/4	RPT CG0601	
		41	29	17	22.5	12.8	6 mm	G 3/8	RPT CG0602	
		41	30	21	22	12.8	6 mm	G 1/2	RPT CG0603	
		45	29.5	14	24	13.8	8 mm	G 1/8	RPT CG0800	
		45	29.5	14	23.5	13.8	8 mm	G 1/4	RPT CG0801	
		45	31	17	24.5	13.8	8 mm	G 3/8	RPT CG0802	
		45	32	21	24	13.8	8 mm	G 1/2	RPT CG0803	
		52.6	33.7	17	28.2	16.8	10 mm	G 1/8	RPT CG1000	
		52.6	34.2	17	28.2	16.8	10 mm	G 1/4	RPT CG1001	
		52.6	34.2	17	27.7	16.8	10 mm	G 3/8	RPT CG1002	
		52.6	35.2	21	27.2	16.8	10 mm	G 1/2	RPT CG1003	
		55.6	35	19	29	19.8	12 mm	G 1/4	RPT CG1201	
		55.6	34.5	19	28	19.8	12 mm	G 3/8	RPT CG1202	
		55.6	35.5	21	27.5	19.8	12 mm	G 1/2	RPT CG1203	
		62	39.3	22	32.8	22.7	14 mm	G 3/8	RPT CG1402	
		62	38.5	22	30.5	22.7	14 mm	G 1/2	RPT CG1403	
64.6	43	24	36.5	23.8	16 mm	G 3/8	RPT CG1602			
64.6	40.5	24	32.5	23.8	16 mm	G 1/2	RPT CG1603			

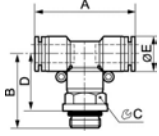

RACCORDS INSTANTANES POLYMERE

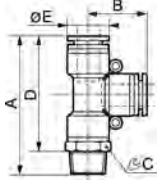
RACCORDS IMPLANTATION

Fluide Air	Diamètre Tubes: Ø ext. 4 à 16 mm	Pression 0 à 10 bar	Température 0 à 60° C		Matière Filetages : laiton nickelé			Matière polymère (raccords droits : laiton nickelé)	Compatibilité PU - PA	Etanchéité Mâle cylindrique avec joint	Etanchéité Mâle conique préfileté
			A	B	C	D	E				
Té mâle cylindrique au centre orientable - RPT CG											
		35	25	10	21	10	Tube Ø ext. 4 mm	Filetage métrique M5	RPT CG04M5		
		41	27.5	12	23.5	12.8	5 mm	M5	RPT CG05M5		
		41	27.5	12	23.5	12.8	6 mm	M5	RPT CG06M5		
Té mâle latéral conique orientable - RPT AR											
		42.5	17.5	10	35	10	Tube Ø ext. 4 mm	Filetage Gaz BSP R 1/8	RPT AR0400		
		44	17.5	14	35	10	4 mm	R 1/4	RPT AR0401		
		48	20.5	12	40.5	12.8	5 mm	R 1/8	RPT AR0500		
		49.5	20.5	14	40.5	12.8	5 mm	R 1/4	RPT AR0501		
		52	20.5	17	41	12.8	5 mm	R 3/8	RPT AR0502		
		54.5	20.5	21	41.5	12.8	5 mm	R 1/2	RPT AR0503		
		48	20.5	12	40.5	12.8	6 mm	R 1/8	RPT AR0600		
		49.5	20.5	14	40.5	12.8	6 mm	R 1/4	RPT AR0601		
		52	20.5	17	41	12.8	6 mm	R 3/8	RPT AR0602		
		54.5	20.5	21	41.5	12.8	6 mm	R 1/2	RPT AR0603		
		52	22.5	14	44.5	13.8	8 mm	R 1/8	RPT AR0800		
		53.5	22.5	14	44.5	13.8	8 mm	R 1/4	RPT AR0801		
		56	22.5	17	45	13.8	8 mm	R 3/8	RPT AR0802		
		58.5	22.5	21	45.5	13.8	8 mm	R 1/2	RPT AR0803		
		59.5	26.3	17	52	16.8	10 mm	R 1/8	RPT AR1000		
		61	26.3	17	52	16.8	10 mm	R 1/4	RPT AR1001		
		63	26.3	17	52	16.8	10 mm	R 3/8	RPT AR1002		
		65.5	26.3	21	52.5	16.8	10 mm	R 1/2	RPT AR1003		
		63.3	27.8	19	54.3	19.8	12 mm	R 1/4	RPT AR1201		
		65.8	27.8	19	54.8	19.8	12 mm	R 3/8	RPT AR1202		
67.8	27.8	21	54.8	19.8	12 mm	R 1/2	RPT AR1203				
72.2	31	22	61.2	22.7	14 mm	R 3/8	RPT AR1402				
74.2	31	22	61.2	22.7	14 mm	R 1/2	RPT AR1403				
75.3	32.3	24	64.3	23.8	16 mm	R 3/8	RPT AR1602				
77.3	32.3	24	64.3	23.8	16 mm	R 1/2	RPT AR1603				



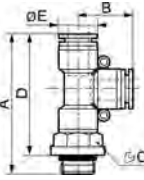

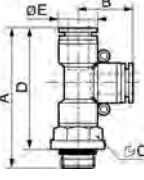
RACCORDS INSTANTANES POLYMERE

RACCORDS IMPLANTATION

Fluide Air	Diamètre Tubes: Ø ext. 4 à 16 mm	Pression 0 à 10 bar	Température 0 à 60° C		Matière Filetages : laiton nickelé			Matière polymère (raccords droits : laiton nickelé)	Compatibilité PU - PA	Etanchéité Mâle cylindrique avec joint	Etanchéité Mâle conique préflonné
			A	B	C	D	E				
Té mâle latéral cylindrique orientable - RPT AG											
		41.1	17.5	12	35.6	10	Tube Ø ext. 4 mm	Filetage Gaz BSP G 1/8	RPT AG0400		
		41.5	17.5	14	35.5	10	4 mm	G 1/4	RPT AG0401		
		47.5	20.5	12	42	12.8	5 mm	G 1/8	RPT AG0500		
		48	20.5	14	42	12.8	5 mm	G 1/4	RPT AG0501		
		49.5	20.5	17	43	12.8	5 mm	G 3/8	RPT AG0502		
		50.5	20.5	21	42.5	12.8	5 mm	G 1/2	RPT AG0503		
		47.5	20.5	12	42	12.8	6 mm	G 1/8	RPT AG0600		
		48	20.5	14	42	12.8	6 mm	G 1/4	RPT AG0601		
		49.5	20.5	17	43	12.8	6 mm	G 3/8	RPT AG0602		
		50.5	20.5	21	42.5	12.8	6 mm	G 1/2	RPT AG0603		
		52	22.5	14	46.5	13.8	8 mm	G 1/8	RPT AG0800		
		52	22.5	14	46	13.8	8 mm	G 1/4	RPT AG0801		
		53.5	22.5	17	47	13.8	8 mm	G 3/8	RPT AG0802		
		54.5	22.5	21	46.5	13.8	8 mm	G 1/2	RPT AG0803		
		60	26.3	17	54.5	16.8	10 mm	G 1/8	RPT AG1000		
		60.5	26.3	17	54.5	16.8	10 mm	G 1/4	RPT AG1001		
		60.5	26.3	17	54	16.8	10 mm	G 3/8	RPT AG1002		
		61.5	26.3	21	53.5	16.8	10 mm	G 1/2	RPT AG1003		
		62.8	27.8	19	56.8	19.8	12 mm	G 1/4	RPT AG1201		
		62.3	27.8	19	55.8	19.8	12 mm	G 3/8	RPT AG1202		
63.3	27.8	21	55.3	19.8	12 mm	G 1/2	RPT AG1203				
70.3	31	22	63.8	22.7	14 mm	G 3/8	RPT AG1402				
69.5	31	22	61.5	22.7	14 mm	G 1/2	RPT AG1403				
75.3	32.3	24	68.8	23.8	16 mm	G 3/8	RPT AG1602				
72.8	32.3	24	64.8	23.8	16 mm	G 1/2	RPT AG1603				
Té mâle latéral cylindrique orientable - RPT AG											
		42.5	17.5	10	38.5	10	Tube Ø ext. 4 mm	Filetage métrique M5	RPT AG04M5		
		48	20.5	12	44	12.8	5 mm	M5	RPT AG05M5		
		48	20.5	12	44	12.8	6 mm	M5	RPT AG06M5		

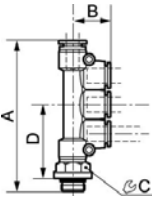

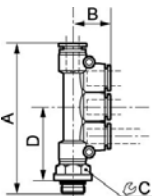
RACCORDS INSTANTANES POLYMERE

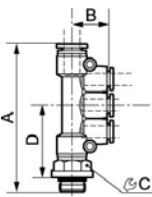
RACCORDS IMPLANTATION

Fluide Air	Diamètre Tubes: Ø ext. 4 à 16 mm	Pression 0 à 10 bar	Température 0 à 60° C					Matière Filetages : laiton nickelé	Matière polymère (raccords droits : laiton nickelé)	Compatibilité PU - PA	Etanchéité Mâle cylindrique avec joint	Etanchéité Mâle conique préflonné
			A	B	C	D	E					
Union triple égale mâle cylindrique orientable - RPN MG												
								Tube Ø ext.	Filetage Gaz BSP			
		66.7	19.5	12	31.5			4 mm	G 1/8		RPN MG0400	
		67.2	19.5	14	33.5			4 mm	G 1/4		RPN MG0401	
		66.7	19.5	14	31.5			5 mm	G 1/8		RPN MG0500	
		67.2	19.5	14	31.5			5 mm	G 1/4		RPN MG0501	
		68.7	19.5	17	31.5			5 mm	G 3/8		RPN MG0502	
		69.7	19.5	21	31.5			5 mm	G 1/2		RPN MG0503	
		66.7	19.5	14	31.5			6 mm	G 1/8		RPN MG0600	
		67.2	19.5	14	31.5			6 mm	G 1/4		RPN MG0601	
		68.7	19.5	17	31.5			6 mm	G 3/8		RPN MG0602	
		69.7	19.5	21	31.5			6 mm	G 1/2		RPN MG0603	
		67.2	24	17	42			8 mm	G 1/8		RPN MG0800	
		67.2	24	17	42			8 mm	G 1/4		RPN MG0801	
		68.7	24	17	42			8 mm	G 3/8		RPN MG0802	
69.7	24	21	42			8 mm	G 1/2		RPN MG0803			
Union triple égale mâle cylindrique orientable - RPN MG												
							Tube Ø ext.	Filetage métrique				
		66.7	19.5	10	33.5			4 mm	M5		RPN MG04M5	
		66.7	19.5	10	31.5			5 mm	M5		RPN MG05M5	
		66.7	19.5	10	33.5			6 mm	M5		RPN MG06M5	
Union triple inégale mâle cylindrique orientable - RPN KG												
							Tube Ø ext.	Tube Ø ext. x 3	Filetage Gaz BSP			
		66.2	20	14	31.5			6 mm	4 mm	G 1/8	RPN KG6400	
		67	20	14	31.5			8 mm	4 mm	G 1/4	RPN KG8401	
		67.9	20	14	31.5			8 mm	6 mm	G 1/4	RPN KG8601	
		87.8	23	17	42			10 mm	8 mm	G 3/8	RPN KG1082	
		88.8	23	21	42			10 mm	8 mm	G 1/2	RPN KG1083	

RACCORDS INSTANTANES POLYMERE

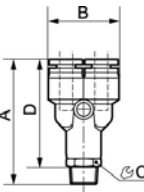
RACCORDS IMPLANTATION

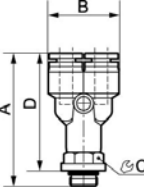
Fluide Air	Diamètre Tubes: Ø ext. 4 à 16 mm	Pression 0 à 10 bar	Température 0 à 60° C		Matière Filetages : laiton nickelé			Matière polymère (raccords droits : laiton nickelé)	Compatibilité PU - PA	Etanchéité Mâle cylindrique avec joint	Etanchéité Mâle conique préflonné
			A	B	C	D	E				
Y mâle conique orientable - RPY MR											
		41.5	20	10	34		Tube Ø ext.	Filetage Gaz BSP			
							4 mm	R 1/8	RPY MR0400		
		43	20	14	34		4 mm	R 1/4	RPY MR0401		
		44	25.6	12	36.5		5 mm	R 1/8	RPY MR0500		
		45.5	25.6	14	36.5		5 mm	R 1/4	RPY MR0501		
		48	25.6	17	37		5 mm	R 3/8	RPY MR0502		
		50.5	25.6	21	37.5		5 mm	R 1/2	RPY MR0503		
		44	25.6	12	36.5		6 mm	R 1/8	RPY MR0600		
		45.5	25.6	14	36.5		6 mm	R 1/4	RPY MR0601		
		48	25.6	17	37		6 mm	R 3/8	RPY MR0602		
		50.5	25.6	21	37.5		6 mm	R 1/2	RPY MR0603		
		44.3	27.6	14	36.8		8 mm	R 1/8	RPY MR0800		
		45.8	27.6	14	36.8		8 mm	R 1/4	RPY MR0801		
		48.3	27.6	17	37.3		8 mm	R 3/8	RPY MR0802		
		50.8	27.6	21	37.8		8 mm	R 1/2	RPY MR0803		
		56.1	33.6	17	48.6		10 mm	R 1/8	RPY MR1000		
		57.6	33.6	17	48.6		10 mm	R 1/4	RPY MR1001		
		59.6	32.6	17	48.6		10 mm	R 3/8	RPY MR1002		
		62.1	33.6	21	49.1		10 mm	R 1/2	RPY MR1003		
		60.8	39.6	19	51.8		12 mm	R 1/4	RPY MR1201		
		63.3	39.6	19	52.3		12 mm	R 3/8	RPY MR1202		
		65.3	39.6	21	52.3		12 mm	R 1/2	RPY MR1203		
		64.8	45.4	22	53.8		14 mm	R 3/8	RPY MR1402		
66.8	45.4	22	53.8		14 mm	R 1/2	RPY MR1403				
66.5	47.6	24	55.5		16 mm	R 3/8	RPY MR1602				
68.5	47.6	24	55.5		16 mm	R 1/2	RPY MR1603				
Y mâle cylindrique orientable - RPY MG											
		40.5	20	12	33		Tube Ø ext.	Filetage Gaz BSP			
							4 mm	G 1/8	RPY MG0400		
		41	20	14	32		4 mm	G 1/4	RPY MG0401		
		43.5	25.6	12	36		5 mm	G 1/8	RPY MG0500		
		44	25.6	14	35		5 mm	G 1/4	RPY MG0501		
		45.5	25.6	17	34.5		5 mm	G 3/8	RPY MG0502		
		46.5	25.6	21	33.5		5 mm	G 1/2	RPY MG0503		
		43.5	25.6	12	36		6 mm	G 1/8	RPY MG0600		
		44	25.6	14	35		6 mm	G 1/4	RPY MG0601		
		45.5	25.6	17	34.5		6 mm	G 3/8	RPY MG0602		
		46.5	25.6	21	33.5		6 mm	G 1/2	RPY MG0603		
		45.3	27.6	14	37.8		8 mm	G 1/8	RPY MG0800		
		45.3	27.6	14	36.3		8 mm	G 1/4	RPY MG0801		
		46.8	27.6	17	35.8		8 mm	G 3/8	RPY MG0802		
		47.8	27.6	21	34.8		8 mm	G 1/2	RPY MG0803		
		57.3	33.6	17	49.8		10 mm	G 1/8	RPY MG1000		
		57.8	33.6	17	48.8		10 mm	G 1/4	RPY MG1001		
		57.8	32.6	17	46.8		10 mm	G 3/8	RPY MG1002		
		58.8	33.6	21	45.8		10 mm	G 1/2	RPY MG1003		
		60.5	39.6	19	51.5		12 mm	G 1/4	RPY MG1201		
		60	39.6	19	49		12 mm	G 3/8	RPY MG1202		
		61.5	39.6	21	48.5		12 mm	G 1/2	RPY MG1203		
		61.6	45.4	22	50.6		14 mm	G 3/8	RPY MG1402		
63.5	45.4	24	50.5		14 mm	G 1/2	RPY MG1403				
64.3	47.6	24	53.3		16 mm	G 3/8	RPY MG1602				
61.8	47.6	24	48.8		16 mm	G 1/2	RPY MG1603				

RACCORDS INSTANTANES POLYMERE

RACCORDS IMPLANTATION

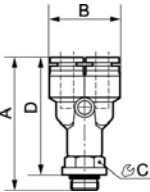
Fluide Air	Diamètre Tubes: Ø ext. 4 à 16 mm	Pression 0 à 10 bar	Température 0 à 60° C	Matière Filetages : laiton nickelé					Matière polymère (raccords droits : laiton nickelé)	Compatibilité PU - PA	Etanchéité Mâle cylindrique avec joint	Etanchéité Mâle conique préflonné
				A	B	C	D	E				
Y mâle cylindrique orientable - RPY MG												
								Tube Ø ext.	Filetage métrique			
		41.4	20	10	37.6			4 mm	M5	RPY MG04M5		
		43.5	26	12	39.8			5 mm	M5	RPY MG05M5		
		43.8	24.8	12	40			6 mm	M5	RPY MG06M5		

RACCORDS INSTANTANES POLYMERE



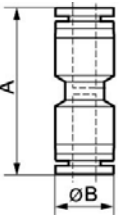

RACCORDS DE LIAISON

Pression 0 à 10 bar	Température 0 à 60° C	Matière Corps: polymère et/ ou laiton nickelé					Fluide Air	Diamètre Tubes: Ø ext. 4 à 16 mm	Compatibilité PU - PA	
		A	B	C	D	E				DESIGNATION
Union égale - RPU ET										
								Tube Ø ext.		
		30	10					4 mm	RPU ET0404	
		36.7	12.8					5 mm	RPU ET0505	
		36.7	12.8					6 mm	RPU ET0606	
		39	13.8					8 mm	RPU ET0808	
		42.2	16.8					10 mm	RPU ET1010	
		44.3	19.8					12 mm	RPU ET1212	
		49.5	22.7					14 mm	RPU ET1414	
49.6	23.8					16 mm	RPU ET1616			

RACCORDS INSTANTANES POLYMERE

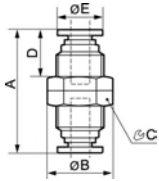

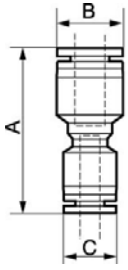

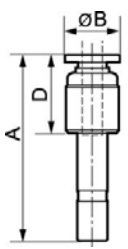

RACCORDS DE LIAISON

Pression 0 à 10 bar	Température 0 à 60° C	Matière Corps: polymère et/ ou laiton nickelé	Fluide Air	Diamètre Tubes: Ø ext. 4 à 16 mm	Compatibilité PU - PA
------------------------	--------------------------	---	---------------	-------------------------------------	--------------------------

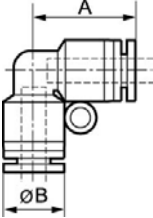
		A	B	C	D	E	DESIGNATION	REFERENCE	
Union traversée de cloison - RPU TT									
							Tube Ø ext.		
		34	16.5	14	13	10	4 mm	RPU TT0404	
		36	20	17	14	12.8	5 mm	RPU TT0505	
		36	20	17	14	12.8	6 mm	RPU TT0606	
		39.5	22	19	15.8	13.8	8 mm	RPU TT0808	
		40.6	28	24	16.5	16.8	10 mm	RPU TT1010	
		44.5	30.5	26	17.8	19.8	12 mm	RPU TT1212	
		52	32.5	28	18.3	23.8	16 mm	RPU TT1616	
Union droite inégale - RPU IT									
							Tube Ø ext.	Tube Ø ext.	
		33.1	12.8	10			6 mm	4 mm	RPU IT0604
		38.3	13.8	12.8			8 mm	6 mm	RPU IT0806
		41.1	16.8	13.8			10 mm	8 mm	RPU IT1008
		45.3	19.8	16.8			12 mm	10 mm	RPU IT1210
		49.6	23.8	19.6			16 mm	12 mm	RPU IT1612
Réduction de piquage - RPR PT									
							Raccord Ø int.	Tube Ø ext.	
		37	10		15.5		5 mm	4 mm	RPR PT0504
		37	10		15.5		6 mm	4 mm	RPR PT0604
		37	10		15.5		8 mm	4 mm	RPR PT0804
		37.5	12.8		16		8 mm	6 mm	RPR PT0806
		41	12.8		16		10 mm	6 mm	RPR PT1006
		44	13.8		19		10 mm	8 mm	RPR PT1008
		43	13.8		18		12 mm	8 mm	RPR PT1208
42.5	16.8		17.5		12 mm	10 mm	RPR PT1210		

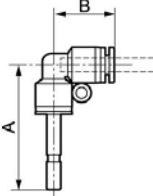

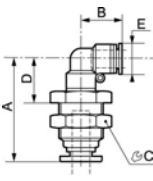
RACCORDS INSTANTANES POLYMERE

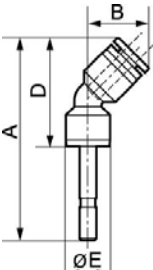
RACCORDS DE LIAISON

Pression 0 à 10 bar		Température 0 à 60° C		Matière Corps: polymère et/ ou laiton nickelé			Fluide Air		Diamètre Tubes: Ø ext. 4 à 16 mm		Compatibilité PU - PA	
		A	B	C	D	E	DESIGNATION		REFERENCE			
Coude égal 90° - RPC ET												
							Tube Ø ext.					
		17.5	10				4 mm	RPC ET0404				
		20.5	12.8				5 mm	RPC ET0505				
		20.5	12.8				6 mm	RPC ET0606				
		22.5	13.8				8 mm	RPC ET0808				
		22.8	13.8				10 mm	RPC ET1010				
		27	16.8				12 mm	RPC ET1212				
		29.8	19.8				14 mm	RPC ET1414				
		30.8	23.8				16 mm	RPC ET1616				
Coude de piquage 90° - RPC PT												
							Tube Ø ext.	Raccord Ø int.				
		31	17.5				4 mm	4 mm	RPC PT0404			
		37.6	20.5				5 mm	5 mm	RPC PT0505			
		38.5	20.5				6 mm	6 mm	RPC PT0606			
		40.5	22.5				8 mm	8 mm	RPC PT0808			
		46.5	26.3				10 mm	10 mm	RPC PT1010			
		48	27.8				12 mm	12 mm	RPC PT1212			
		51.8	29.8				14 mm	14 mm	RPC PT1414			
		54	30.8				16 mm	16 mm	RPC PT1616			
Coude 90° traversée de cloison - RPC TT												
							Tube Ø ext.					
		37	17.5	14	18	10	4 mm	RPC TT0404				
		39.5	20.5	17	18	12.8	5 mm	RPC TT0505				
		40.5	20.5	17	21.5	12.8	6 mm	RPC TT0606				
		45	22.8	19	24	13.8	8 mm	RPC TT0808				
		48	26.3	24	25	16.8	10 mm	RPC TT1010				
		54	27.8	26	27	19.8	12 mm	RPC TT1212				
		51	29.8	26	28	22.7	14 mm	RPC TT1414				
		54	30.8	28	30	23.8	16 mm	RPC TT1616				
Coude de piquage 45° - RPQ PT												
							Tube Ø ext.	Raccord Ø int.				
		45.4	14.7		27.4	10.5	4 mm	4 mm	RPQ PT0404			
		54	16.5		34	13	5 mm	5 mm	RPQ PT0505			
		54	16.5		32	13	6 mm	6 mm	RPQ PT0606			
		57	18.5		35	14.5	8 mm	8 mm	RPQ PT0808			
		65.3	21		40	18	10 mm	10 mm	RPQ PT1010			
		68	24		43	20	12 mm	12 mm	RPQ PT1212			



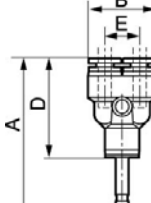

RACCORDS INSTANTANES POLYMERE

RACCORDS DE LIAISON

Pression 0 à 10 bar	Température 0 à 60° C	Matière Corps: polymère et/ ou laiton nickelé					Fluide Air	Diamètre Tubes: Ø ext. 4 à 16 mm		Compatibilité PU - PA
		A	B	C	D	E	DESIGNATION		REFERENCE	
Y égal - RPY ET										
							Tube Ø ext.			
		34	20		10.5	10	4 mm		RPY ET0404	
		37	25.6		13	12.8	5 mm		RPY ET0505	
		37	25.6		13	12.8	6 mm		RPY ET0606	
		37.6	27.6		14.5	13.8	8 mm		RPY ET0808	
		50.6	33.6		18	16.8	10 mm		RPY ET1010	
		53.1	39.6		20	19.8	12 mm		RPY ET1212	
		54.6	45.4		23.3	22.7	14 mm		RPY ET1414	
		56.6	49		24.5	24.5	16 mm		RPY ET1616	
Y inégal - RPY IT										
							Tube Ø ext.	Tube Ø ext. x 2		
		35.5	20		10.5	12.8	6 mm	4 mm	RPY IT0604	
		42	25.6		13	13.8	8 mm	6 mm	RPY IT0806	
		49.6	27.6		14.5	16.8	10 mm	8 mm	RPY IT1008	
		53	33.6		18	19.8	12 mm	10 mm	RPY IT1210	
		56.6	39.6		24.5	24.5	16 mm	12 mm	RPY IT1612	
Y de piquage - RPY PT										
							Tube Ø ext.	Raccord Ø int.		
		48.5	20		31	10.5	4 mm	4 mm	RPY PT0404	
		53.5	25.6		33.5	13	5 mm	5 mm	RPY PT0505	
		55	25.6		33	13	6 mm	6 mm	RPY PT0606	
		55.3	27.6		33.5	14.5	8 mm	8 mm	RPY PT0808	
		70.8	33.6		45.5	18	10 mm	10 mm	RPY PT1010	
		73.3	39.6		48	20	12 mm	12 mm	RPY PT1212	
		75.8	45.4		49	23.3	14 mm	14 mm	RPY PT1414	
		79	47.6		51	24.5	16 mm	16 mm	RPY PT1616	
Y de piquage inégal - RPY PT										
							Raccord Ø int.	Tube Ø ext.		
		52.5	20		31	10.5	6 mm	4 mm	RPY PT0604	
		55	25.6		33.5	13	8 mm	6 mm	RPY PT0806	
		60	27.6		35	14.5	10 mm	8 mm	RPY PT1008	
		70.8	33.6		45.5	18	12 mm	10 mm	RPY PT1210	

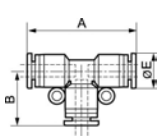

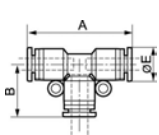

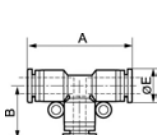
RACCORDS INSTANTANES POLYMERE

RACCORDS DE LIAISON

Pression 0 à 10 bar		Température 0 à 60° C		Matière Corps: polymère et/ ou laiton nickelé		Fluide Air		Diamètre Tubes: Ø ext. 4 à 16 mm		Compatibilité PU - PA	
		A	B	C	D	E	DESIGNATION		REFERENCE		
Té égal - RPT ET											
							Tube Ø ext.				
		35	17.5			10	4 mm		RPT ET0404		
		40	20			12.8	5 mm		RPT ET0505		
		40	20			12.8	6 mm		RPT ET0606		
		45.6	22.8			13.8	8 mm		RPT ET0808		
		54	27			16.8	10 mm		RPT ET1010		
		55.6	27.8			19.8	12 mm		RPT ET1212		
		62	31			22.7	14 mm		RPT ET1414		
64	32			23.8	16 mm		RPT ET1616				
Té inégal - Ø supérieur au centre - RPT JT											
							Tube Ø ext.	Tube Ø ext. x 2			
		40	19.5			10	6 mm	4 mm	RPT JT0604		
		45.6	22.5			12.8	8 mm	6 mm	RPT JT0806		
		54	26.8			13.8	10 mm	8 mm	RPT JT1008		
		55.6	27.1			16.8	12 mm	10 mm	RPT JT1210		
		64	32			16.8	16 mm	12 mm	RPT JT1612		
Té inégal - Ø inférieur au centre - RPT IT											
							Tube Ø ext. x 2	Tube Ø ext.			
		39	20			12.8	6 mm	4 mm	RPT IT0604		
		45	22.8			13.8	8 mm	6 mm	RPT IT0806		
		53.6	27			16.8	10 mm	8 mm	RPT IT1008		
		54.2	27.8			19.8	12 mm	10 mm	RPT IT1210		
		64	32			23.8	16 mm	12 mm	RPT IT1612		

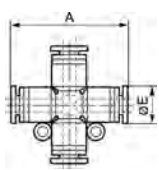

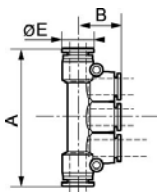

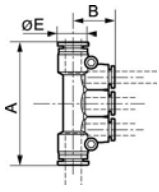

RACCORDS INSTANTANES POLYMERE

RACCORDS DE LIAISON

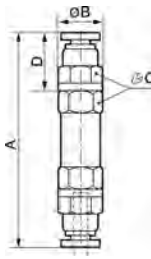
Pression 0 à 10 bar		Température 0 à 60° C		Matière Corps: polymère et/ ou laiton nickelé		Fluide Air		Diamètre Tubes: Ø ext. 4 à 16 mm		Compatibilité PU - PA	
		A	B	C	D	E	DESIGNATION		REFERENCE		
Croix égale - RPX ET											
							Tube Ø ext.				
		35.4				10	4 mm	RPX ET0404			
		41				12.8	5 mm	RPX ET0505			
		41				12.8	6 mm	RPX ET0606			
		45.6				13.8	8 mm	RPX ET0808			
		52.6				16.8	10 mm	RPX ET1010			
		58.6				19.8	12 mm	RPX ET1212			
Union multiple égale - RPN ET											
							Tube Ø ext.				
		59	19.5			10	4 mm	RPN ET0404			
		60.5	19.5			12.8	5 mm	RPN ET0505			
		60.5	19.5			12.8	6 mm	RPN ET0606			
		79.6	24			13.8	8 mm	RPN ET0808			
Union multiple inégale - RPN IT											
							Tube Ø ext. x 2	Tube Ø ext. x 3			
		60.2	19.5			12.8	6 mm	4 mm	RPN IT0604		
		60.8	19.5			13.8	8 mm	4 mm	RPN IT0804		
		60.8	19.5			13.8	8 mm	6 mm	RPN IT0806		
		81	23			16.8	10 mm	6 mm	RPN IT1006		
		81	24			16.8	10 mm	8 mm	RPN IT1008		

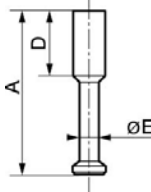
RACCORDS INSTANTANES POLYMERE

RACCORDS DE LIAISON

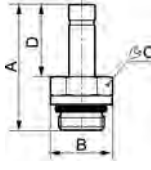
Pression 0 à 10 bar	Température 0 à 60° C	Matière Corps: polymère et/ ou laiton nickelé					Fluide Air	Diamètre Tubes: Ø ext. 4 à 16 mm	Compatibilité PU - PA
		A	B	C	D	E	DESIGNATION	REFERENCE	
Clapet anti-retour - RPA ET									
							Tube Ø ext.	Tube Ø ext.	
		63	16.5	16	13		4 mm	RPA ET0404	
		66	16.5	16	15		5 mm	RPA ET0505	
		66	16.5	16	15		6 mm	RPA ET0606	
		71	16.5	16	16		8 mm	RPA ET0808	
		79	20	16	21.8		10 mm	RPA ET1010	
		87	22	16	24		12 mm	RPA ET1212	
Bouchon - RPH PT									
							Raccord Ø int.		
		30			15.5	2	4 mm	RPH PT0404	
		34			18	3	6 mm	RPH PT0606	
		37			18.5	4	8 mm	RPH PT0808	
		39.5			20.5	5	10 mm	RPH PT1010	
44			23	6	12 mm	RPH PT1212			
Douille de jonction - RPJ PG									
			F	12	18		Raccord Ø int.	Filetage Gaz BSP	
		29	13.9	12	18		4 mm	G 1/8	RPJ PG0400
		29	13.9	12	18		5 mm	G 1/8	RPJ PG0500
		31	19.6	17	18		5 mm	G 1/4	RPJ PG0501
		29	13.9	12	18		6 mm	G 1/8	RPJ PG0600
		31	19.6	17	18		6 mm	G 1/4	RPJ PG0601
		32	13.9	12	21		8 mm	G 1/8	RPJ PG0800
		34	19.6	17	21		8 mm	G 1/4	RPJ PG0801
		35	21.9	19	21		8 mm	G 3/8	RPJ PG0802
		36	19.6	17	23		10 mm	G 1/4	RPJ PG1001
		37	21.9	19	23.5		10 mm	G 3/8	RPJ PG1002
36.5	19.6	17	23.5		12 mm	G 1/4	RPJ PG1201		
37.5	21.9	19	23.5		12 mm	G 3/8	RPJ PG1202		
Douille de jonction - RPJ PG									
							Raccord Ø int.	Filetage métrique	
		27	10.4	9	18		4 mm	M5	RPJ PG04M5
		27	9.2	8	18		5 mm	M5	RPJ PG05M5
27	11.5	10	18		6 mm	M5	RPJ PG06M5		

ASSORTIMENT DE RACCORDS INSTANTANES CONEX

		A	B	C	DESIGNATION	REFERENCE
Mallette de raccords instantanés polymère CONEX						
		385	280	55	Assortiment de 150 raccords instantanés CONEX : 50 raccords droits mâles 40 coudes mâles coniques 10 coudes mâles cylindriques 30 unions égales 20 tés égaux 1 coupe tube	MAL RP150

RACCORDS INSTANTANES POLYMERE MICRO VANNES A DECOMPRESSION



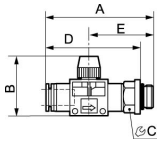

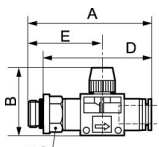
Fluide Air	Matière Corps : Polymère Filetage : laiton nickelé	Température 0°C à + 60°C	Pression 0 à 10 bar	Diamètre Tubes: Ø ext. 6 à 12 mm	Compatibilité PA - PU	Filetage Filetages mâles cylindriques avec joint
---------------	---	-----------------------------	------------------------	--	--------------------------	---

		A	B	C	D	E	DESIGNATION	REFERENCE	
Micro Vanne - Tube/Filetage mâle cylindrique - RPS PG									
							Tube Ø ext.	Filetage Gaz BSP	
		58	40.3	14	52.5	32.5	6 mm	G 1/8	RPS PG0600
		58	40.3	14	52	32.5	6 mm	G 1/4	RPS PG0601
		59.5	40.3	17	53	34	6 mm	G 3/8	RPS PG0602
		58.3	40.3	14	52.8	32.5	8 mm	G 1/8	RPS PG0800
		58.3	40.3	14	52.3	32.5	8 mm	G 1/4	RPS PG0801
		59.8	40.3	17	53.3	34	8 mm	G 3/8	RPS PG0802
		70.1	44.5	17	64.1	39	10 mm	G 1/4	RPS PG1001
		69.6	44.5	17	63.1	38.5	10 mm	G 3/8	RPS PG1002
		71.1	44.5	21	63.1	40	10 mm	G 1/2	RPS PG1003
		70.8	44.5	17	64.8	39	12 mm	G 1/4	RPS PG1201
		70.3	44.5	17	63.8	38.5	12 mm	G 3/8	RPS PG1202
		71.8	44.5	21	63.8	40	12 mm	G 1/2	RPS PG1203

		A	B	C	D	E	DESIGNATION	REFERENCE	
Micro Vanne - Filetage mâle cylindrique/Tube - RPS TG									
							Tube Ø ext.	Filetage Gaz BSP	
		58	40.3	14	52.5	32.5	6 mm	G 1/8	RPS TG0600
		58	40.3	14	52	32.5	6 mm	G 1/4	RPS TG0601
		59.5	40.3	17	53	34	6 mm	G 3/8	RPS TG0602
		58.3	40.3	14	52.8	32.5	8 mm	G 1/8	RPS TG0800
		58.3	40.3	14	52.3	32.5	8 mm	G 1/4	RPS TG0801
		59.8	40.3	17	53.3	34	8 mm	G 3/8	RPS TG0802
		70.1	44.5	17	64.1	39	10 mm	G 1/4	RPS TG1001
		69.6	44.5	17	63.1	38.5	10 mm	G 3/8	RPS TG1002
		71.1	44.5	21	63.1	40	10 mm	G 1/2	RPS TG1003
		70.8	44.5	17	64.8	39	12 mm	G 1/4	RPS TG1201
		70.3	44.5	17	63.8	38.5	12 mm	G 3/8	RPS TG1202
		71.8	44.5	21	63.8	40	12 mm	G 1/2	RPS TG1203

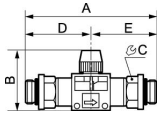

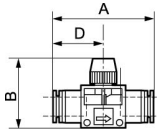

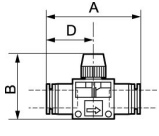
RACCORDS INSTANTANES POLYMERE MICRO VANNES A DECOMPRESSION

Fluide Air	Matière Corps : Polymère Filetage : laiton nickelé	Température 0°C à + 60°C	Pression 0 à 10 bar	Diamètre Tubes: Ø ext. 6 à 12 mm	Compatibilité PA - PU	Filetage Filetages mâles cylindriques avec joint
---------------	---	-----------------------------	------------------------	--	--------------------------	---

		A	B	C	D	E	DESIGNATION		REFERENCE
Micro Vanne - Filetages mâles cylindriques - RPS DG									
							Filetage Gaz BSP	Filetage Gaz BSP	
		65	40.3	14	32.5	32.5	G 1/8	G 1/8	RPS DG0000
		66.5	40.3	14	34	32.5	G 1/4	G 1/8	RPS DG0100
		68	40.3	14	34	34	G 1/4	G 1/4	RPS DG0101
		81.5	44.5	17	42	39.5	G 3/8	G 1/4	RPS DG0201
		84	44.5	17	42	42	G 3/8	G 3/8	RPS DG0202
		86	44.5	21	44	42	G 1/2	G 3/8	RPS DG0302
88	44.5	21	44	44	G 1/2	G 1/2	RPS DG0303		
Micro Vanne - Tubes égaux - RPS ET									
							Tube Ø ext.		
		51	40.3		25.5		6 mm		RPS ET0606
		51.6	40.3		25.8		8 mm		RPS ET0808
		62.2	44.5		31.1		10 mm		RPS ET1010
63.6	44.5		31.8		12 mm		RPS ET1212		
Micro Vanne - Tubes inégaux - RPS IT									
							Tube Ø ext.	Tube Ø ext.	
		51.3	40.3		25.8		8 mm	6 mm	RPS IT0806
62.9	44.5		31.8		12 mm	10 mm	RPS IT1210		

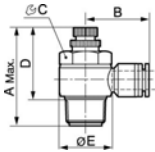
RACCORDS INSTANTANES POLYMERE REGLEURS DE DEBITS

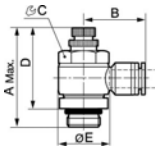

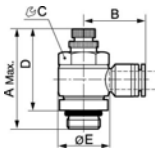

Fluide Air	Température 0°C à 60°C	Matière Corps: Polymère - Filetage: laiton nickelé	Pression 0 à 10 bar	Compatibilité PA - PU	Diamètre Tubes: Ø ext. 4 à 12 mm	Filetage Mâle conique préfileté - Cylindrique avec joint
---------------	---------------------------	--	------------------------	--------------------------	--	---

		A	B	C	D	E	DESIGNATION		REFERENCE
Régleur de débit mâle conique à molette - admission - RPM IR									
							Tube Ø ext.	Filetage Gaz BSP	
		41	21.8	10	33.5	14.5	4 mm	R 1/8	RPM IR0400
		49	24	14	40	18.2	4 mm	R 1/4	RPM IR0401
		41	23	10	33.5	14.5	6 mm	R 1/8	RPM IR0600
		49	25.5	14	40	18.2	6 mm	R 1/4	RPM IR0601
		58	27.1	19	47	22	6 mm	R 3/8	RPM IR0602
		63	30.1	24	50	27.4	6 mm	R 1/2	RPM IR0603
		41	24.6	10	33.5	14.5	8 mm	R 1/8	RPM IR0800
		49	26.8	14	40	18.2	8 mm	R 1/4	RPM IR0801
		58	28.8	19	47	22	8 mm	R 3/8	RPM IR0802
		63	30.5	24	50	27.4	8 mm	R 1/2	RPM IR0803
		41	28.5	10	33.5	14.5	10 mm	R 1/8	RPM IR1000
		49	31	14	40	18.2	10 mm	R 1/4	RPM IR1001
		58	31	19	47	22	10 mm	R 3/8	RPM IR1002
		63	34	24	50	27.4	10 mm	R 1/2	RPM IR1003
		49	31.8	14	40	18.2	12 mm	R 1/4	RPM IR1201
58	34	19	47	22	12 mm	R 3/8	RPM IR1202		
63	35.8	24	50	27.4	12 mm	R 1/2	RPM IR1203		
Régleur de débit mâle cylindrique à molette - admission - RPM IG									
							Tube Ø ext.	Filetage Gaz BSP	
		40	21.8	10	34.5	14.5	4 mm	G 1/8	RPM IG0400
		47	24	14	41	18.2	4 mm	G 1/4	RPM IG0401
		40	23	10	34.5	14.5	6 mm	G 1/8	RPM IG0600
		47	25.5	14	41	18.2	6 mm	G 1/4	RPM IG0601
		59	27.1	19	52.5	22	6 mm	G 3/8	RPM IG0602
		63	30.1	24	55	27.4	6 mm	G 1/2	RPM IG0603
		40	24.6	10	34.5	14.5	8 mm	G 1/8	RPM IG0800
		47	26.8	14	41	18.2	8 mm	G 1/4	RPM IG0801
		59	28.8	19	52.5	22	8 mm	G 3/8	RPM IG0802
		63	30.5	24	55	27.4	8 mm	G 1/2	RPM IG0803
		40	28.5	10	34.5	14.5	10 mm	G 1/8	RPM IG1000
		47	31	14	41	18.2	10 mm	G 1/4	RPM IG1001
		59	31	19	52.5	22	10 mm	G 3/8	RPM IG1002
		63	34	24	55	27.4	10 mm	G 1/2	RPM IG1003
		47	31.8	14	41	18.2	12 mm	G 1/4	RPM IG1201
59	34	19	52.5	22	12 mm	G 3/8	RPM IG1202		
63	35.8	24	55	27.4	12 mm	G 1/2	RPM IG1203		
Régleur de débit mâle cylindrique à molette - admission - RPM IG									
							Tube Ø ext.	Filetage métrique	
		31	19.7	8	27	10	4 mm	M5	RPM IG04M5
		31	22.5	8	27	10	6 mm	M5	RPM IG06M5

RACCORDS INSTANTANES POLYMERE

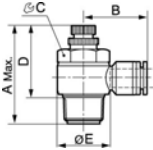

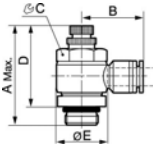

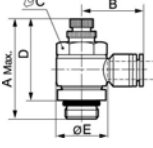
REGLEURS DE DEBITS

Fluide Air	Température 0°C à 60°C	Matière Corps: Polymère - Filetage: laiton nickelé	Pression 0 à 10 bar	Compatibilité PA - PU	Diamètre Tubes: Ø ext. 4 à 12 mm	Filetage Mâle conique préfileté - Cylindrique avec joint
---------------	---------------------------	--	------------------------	--------------------------	--	---

		A	B	C	D	E	DESIGNATION		REFERENCE
Régleur de débit mâle conique à molette - échappement - RPM OR									
							Tube Ø ext.	Filetage Gaz BSP	
		39	21.8	10	31.5	14.5	4 mm	R 1/8	RPM OR0400
		50	24	14	41	18.2	4 mm	R 1/4	RPM OR0401
		39	23	10	31.5	14.5	6 mm	R 1/8	RPM OR0600
		50	25.5	14	41	18.2	6 mm	R 1/4	RPM OR0601
		59	27.1	19	48	22	6 mm	R 3/8	RPM OR0602
		63	30.1	24	50	27.4	6 mm	R 1/2	RPM OR0603
		39	24.6	10	31.5	14.5	8 mm	R 1/8	RPM OR0800
		50	26.8	14	41	18.2	8 mm	R 1/4	RPM OR0801
		59	28.8	19	48	22	8 mm	R 3/8	RPM OR0802
		63	30.5	24	50	27.4	8 mm	R 1/2	RPM OR0803
		39	28.5	10	31.5	14.5	10 mm	R 1/8	RPM OR1000
		50	31	14	41	18.2	10 mm	R 1/4	RPM OR1001
		59	31	19	48	22	10 mm	R 3/8	RPM OR1002
		63	34	24	50	27.4	10 mm	R 1/2	RPM OR1003
50	31.8	14	41	18.2	12 mm	R 1/4	RPM OR1201		
59	34	19	48	14.5	12 mm	R 3/8	RPM OR1202		
63	35.8	24	50	27.4	12 mm	R 1/2	RPM OR1203		
Régleur de débit mâle cylindrique à molette - échappement - RPM OG									
							Tube Ø ext.	Filetage Gaz BSP	
		40	21.8	10	34.5	14.5	4 mm	G 1/8	RPM OG0400
		47	24	14	41	18.2	4 mm	G 1/4	RPM OG0401
		40	23	10	34.5	14.5	6 mm	G 1/8	RPM OG0600
		47	25.5	14	41	18.2	6 mm	G 1/4	RPM OG0601
		59	27.1	19	52.5	22	6 mm	G 3/8	RPM OG0602
		63	30.1	24	55	27.4	6 mm	G 1/2	RPM OG0603
		40	24.6	10	34.5	14.5	8 mm	G 1/8	RPM OG0800
		47	26.8	14	41	18.2	8 mm	G 1/4	RPM OG0801
		59	28.8	19	52.5	22	8 mm	G 3/8	RPM OG0802
		63	30.5	24	55	27.4	8 mm	G 1/2	RPM OG0803
		40	28.5	10	34.5	14.5	10 mm	G 1/8	RPM OG1000
		47	31	14	41	18.2	10 mm	G 1/4	RPM OG1001
		59	31	19	52.5	22	10 mm	G 3/8	RPM OG1002
		63	34	24	55	27.4	10 mm	G 1/2	RPM OG1003
47	31.8	14	41	18.2	12 mm	G 1/4	RPM OG1201		
59	34	19	52.5	22	12 mm	G 3/8	RPM OG1202		
63	35.8	24	55	27.4	12 mm	G 1/2	RPM OG1203		
Régleur de débit mâle cylindrique à molette - échappement - RPM OG									
		31	19.7	8	27	10	4 mm	M5	RPM OG04M5
		31	22.5	8	27	10	6 mm	M5	RPM OG06M5

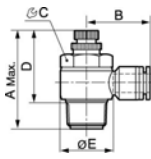

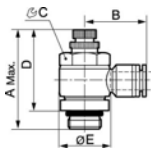

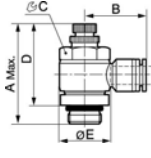
RACCORDS INSTANTANES POLYMERE REGLEURS DE DEBITS

Fluide Air	Température 0°C à 60°C	Matière Corps: Polymère - Filetage: laiton nickelé	Pression 0 à 10 bar	Compatibilité PA - PU	Diamètre Tubes: Ø ext. 4 à 12 mm	Filetage Mâle conique préfileté - Cylindrique avec joint
---------------	---------------------------	--	------------------------	--------------------------	--	---

		A	B	C	D	E	DESIGNATION		REFERENCE
Régleur de débit mâle conique à molette - bidirectionnel - RPM BR									
							Tube Ø ext.	Filetage Gaz BSP	
		42	21.8	10	34.5	14.5	4 mm	R 1/8	RPM BR0400
		46	24	14	37	18.2	4 mm	R 1/4	RPM BR0401
		42	23	10	34.5	14.5	6 mm	R 1/8	RPM BR0600
		46	25.5	14	37	18.2	6 mm	R 1/4	RPM BR0601
		55.5	27.1	19	44.5	22	6 mm	R 3/8	RPM BR0602
		61.5	30.1	24	48.5	27.4	6 mm	R 1/2	RPM BR0603
		42	24.6	10	34.5	14.5	8 mm	R 1/8	RPM BR0800
		46	26.8	14	37	18.2	8 mm	R 1/4	RPM BR0801
		55.5	28.8	19	44.5	22	8 mm	R 3/8	RPM BR0802
		61.5	30.5	24	48.5	27.4	8 mm	R 1/2	RPM BR0803
		42	28.5	10	34.5	14.5	10 mm	R 1/8	RPM BR1000
		46	31	14	37	18.2	10 mm	R 1/4	RPM BR1001
		55.5	31	19	44.5	22	10 mm	R 3/8	RPM BR1002
		61.5	34	24	48.5	27.4	10 mm	R 1/2	RPM BR1003
		46	31.8	14	37	18.2	12 mm	R 1/4	RPM BR1201
55.5	34	19	44.5	22	12 mm	R 3/8	RPM BR1202		
61.5	35.8	24	48.5	27.4	12 mm	R 1/2	RPM BR1203		
Régleur de débit mâle cylindrique à molette - bidirectionnel - RPM BG									
							Tube Ø ext.	Filetage Gaz BSP	
		42	21.8	10	36	14.5	4 mm	G 1/8	RPM BG0400
		46	24	14	39.5	18.2	4 mm	G 1/4	RPM BG0401
		42	23	10	36	14.5	6 mm	G 1/8	RPM BG0600
		46	25.5	14	39.5	18.2	6 mm	G 1/4	RPM BG0601
		55	27.1	19	47.5	22	6 mm	G 3/8	RPM BG0602
		61	30.1	24	52	27.4	6 mm	G 1/2	RPM BG0603
		42	24.6	10	36	14.5	8 mm	G 1/8	RPM BG0800
		46	26.8	14	39.5	18.2	8 mm	G 1/4	RPM BG0801
		55	28.8	19	47.5	22	8 mm	G 3/8	RPM BG0802
		61	30.5	24	52	27.4	8 mm	G 1/2	RPM BG0803
		42	28.5	10	36	14.5	10 mm	G 1/8	RPM BG1000
		46	31	14	39.5	18.2	10 mm	G 1/4	RPM BG1001
		55	31	19	47.5	22	10 mm	G 3/8	RPM BG1002
		61	34	24	52	27.4	10 mm	G 1/2	RPM BG1003
		46	31.8	14	39.5	18.2	12 mm	G 1/4	RPM BG1201
55	34	19	47.5	22	12 mm	G 3/8	RPM BG1202		
61	35.8	24	52	27.4	12 mm	G 1/2	RPM BG1203		
Régleur de débit mâle cylindrique à molette - bidirectionnel - RPM BG									
		32	19.7	8	28	10	4 mm	M5	RPM BG04M5
		32	22.5	8	28	10	6 mm	M5	RPM BG06M5

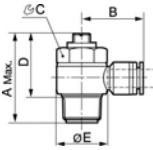

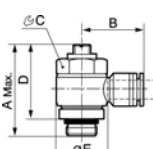

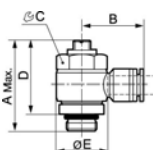
RACCORDS INSTANTANES POLYMERE REGLEURS DE DEBITS

Fluide Air	Température 0°C à 60°C	Matière Corps: Polymère - Filetage: laiton nickelé	Pression 0 à 10 bar	Compatibilité PA - PU	Diamètre Tubes: Ø ext. 4 à 12 mm	Filetage Mâle conique préfileté - Cylindrique avec joint
---------------	---------------------------	--	------------------------	--------------------------	--	---

		A	B	C	D	E	DESIGNATION		REFERENCE
Régleur de débit mâle conique à vis - admission - RPV IR									
							Tube Ø ext.	Filetage Gaz BSP	
		33	21.8	10	25.5	14.5	4 mm	R 1/8	RPV IR0400
		41	24	14	32	18.2	4 mm	R 1/4	RPV IR0401
		33	23	10	25.5	14.5	6 mm	R 1/8	RPV IR0600
		41	25.5	14	32	18.2	6 mm	R 1/4	RPV IR0601
		52	27.1	19	41	22	6 mm	R 3/8	RPV IR0602
		57	30.1	24	44	27.4	6 mm	R 1/2	RPV IR0603
		33	24.6	10	25.5	14.5	8 mm	R 1/8	RPV IR0800
		41	26.8	14	32	18.2	8 mm	R 1/4	RPV IR0801
		52	28.8	19	41	22	8 mm	R 3/8	RPV IR0802
		57	30.5	24	44	27.4	8 mm	R 1/2	RPV IR0803
		33	28.5	10	25.5	14.5	10 mm	R 1/8	RPV IR1000
		41	31	14	32	18.2	10 mm	R 1/4	RPV IR1001
		52	31	19	41	22	10 mm	R 3/8	RPV IR1002
		57	34	24	44	27.4	10 mm	R 1/2	RPV IR1003
		41	31.8	14	32	18.2	12 mm	R 1/4	RPV IR1201
52	34	19	41	22	12 mm	R 3/8	RPV IR1202		
57	35.8	24	44	27.4	12 mm	R 1/2	RPV IR1203		
Régleur de débit mâle cylindrique à vis - admission - RPV IG									
							Tube Ø ext.	Filetage Gaz BSP	
		32	21.8	10	26.5	14.5	4 mm	G 1/8	RPV IG0400
		39	24	14	33	18.2	4 mm	G 1/4	RPV IG0401
		32	23	10	26.5	14.5	6 mm	G 1/8	RPV IG0600
		39	25.5	14	33	18.2	6 mm	G 1/4	RPV IG0601
		51.5	27.1	19	45	22	6 mm	G 3/8	RPV IG0602
		55.5	30.1	24	47.5	27.4	6 mm	G 1/2	RPV IG0603
		32	24.6	10	26.5	14.5	8 mm	G 1/8	RPV IG0800
		39	26.8	14	33	18.2	8 mm	G 1/4	RPV IG0801
		51.5	28.8	19	45	22	8 mm	G 3/8	RPV IG0802
		55.5	30.5	24	47.5	27.4	8 mm	G 1/2	RPV IG0803
		32	28.5	10	26.5	14.5	10 mm	G 1/8	RPV IG1000
		39	31	14	33	18.2	10 mm	G 1/4	RPV IG1001
		51.5	31	19	45	22	10 mm	G 3/8	RPV IG1002
		55.5	34	24	47.5	27.4	10 mm	G 1/2	RPV IG1003
		39	31.8	14	33	18.2	12 mm	G 1/4	RPV IG1201
51.5	34	19	45	22	12 mm	G 3/8	RPV IG1202		
55.5	35.8	24	47.5	27.4	12 mm	G 1/2	RPV IG1203		
Régleur de débit mâle cylindrique à vis - admission - RPV IG									
		25	19.7	8	21	10	4 mm	M5	RPV IG04M5
		25	22.5	8	21	10	6 mm	M5	RPV IG06M5

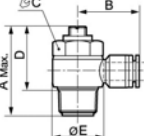

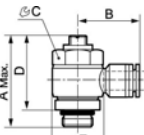

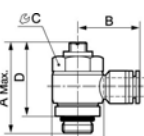
RACCORDS INSTANTANES POLYMERE REGLEURS DE DEBITS

Fluide Air	Température 0°C à 60°C	Matière Corps: Polymère - Filetage: laiton nickelé	Pression 0 à 10 bar	Compatibilité PA - PU	Diamètre Tubes: Ø ext. 4 à 12 mm	Filetage Mâle conique préfileté - Cylindrique avec joint
---------------	---------------------------	--	------------------------	--------------------------	--	---

		A	B	C	D	E	DESIGNATION		REFERENCE
Régleur de débit mâle conique à vis - échappement - RPV OR									
							Tube Ø ext.	Filetage Gaz BSP	
		33	21.8	10	25.5	14.5	4 mm	R 1/8	RPV OR0400
		41	24	14	32	18.2	4 mm	R 1/4	RPV OR0401
		33	23	10	25.5	14.5	6 mm	R 1/8	RPV OR0600
		41	25.5	14	32	18.2	6 mm	R 1/4	RPV OR0601
		52	27.1	19	41	22	6 mm	R 3/8	RPV OR0602
		57	30.1	24	44	27.4	6 mm	R 1/2	RPV OR0603
		33	24.6	10	25.5	14.5	8 mm	R 1/8	RPV OR0800
		41	26.8	14	32	18.2	8 mm	R 1/4	RPV OR0801
		52	28.8	19	41	22	8 mm	R 3/8	RPV OR0802
		57	30.5	24	44	27.4	8 mm	R 1/2	RPV OR0803
		33	28.5	10	25.5	14.5	10 mm	R 1/8	RPV OR1000
		41	31	14	32	18.2	10 mm	R 1/4	RPV OR1001
		52	31	19	41	22	10 mm	R 3/8	RPV OR1002
		57	34	24	44	27.4	10 mm	R 1/2	RPV OR1003
		41	31.8	14	32	18.2	12 mm	R 1/4	RPV OR1201
52	34	19	41	22	12 mm	R 3/8	RPV OR1202		
57	35.8	24	44	27.4	12 mm	R 1/2	RPV OR1203		
Régleur de débit mâle cylindrique à vis - échappement - RPV OG									
							Tube Ø ext.	Filetage Gaz BSP	
		33	21.8	10	27.5	14.5	4 mm	G 1/8	RPV OG0400
		40	24	14	34	18.2	4 mm	G 1/4	RPV OG0401
		33	23	10	27.5	14.5	6 mm	G 1/8	RPV OG0600
		40	25.5	14	34	18.2	6 mm	G 1/4	RPV OG0601
		51	27.1	19	44.5	22	6 mm	G 3/8	RPV OG0602
		55.5	30.1	24	47.5	27.4	6 mm	G 1/2	RPV OG0603
		33	24.6	10	27.5	14.5	8 mm	G 1/8	RPV OG0800
		40	26.8	14	34	18.2	8 mm	G 1/4	RPV OG0801
		51	28.8	19	44.5	22	8 mm	G 3/8	RPV OG0802
		55.5	30.5	24	47.5	27.4	8 mm	G 1/2	RPV OG0803
		33	28.5	10	27.5	14.5	10 mm	G 1/8	RPV OG1000
		40	31	14	34	18.2	10 mm	G 1/4	RPV OG1001
		51	31	19	44.5	22	10 mm	G 3/8	RPV OG1002
		55.5	34	24	47.5	27.4	10 mm	G 1/2	RPV OG1003
		40	31.8	14	34	18.2	12 mm	G 1/4	RPV OG1201
51	34	19	44.5	22	12 mm	G 3/8	RPV OG1202		
55.5	35.8	24	47.5	27.4	12 mm	G 1/2	RPV OG1203		
Régleur de débit mâle cylindrique à vis - échappement - RPV OG									
		25.5	19.7	8	21.5	10	4 mm	M5	RPV OG04M5
		25.5	22.5	8	21.5	10	6 mm	M5	RPV OG06M5

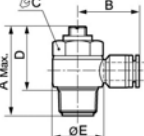

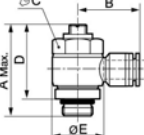

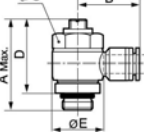
RACCORDS INSTANTANES POLYMERE REGLEURS DE DEBITS

Fluide Air	Température 0°C à 60°C	Matière Corps: Polymère - Filetage: laiton nickelé	Pression 0 à 10 bar	Compatibilité PA - PU	Diamètre Tubes: Ø ext. 4 à 12 mm	Filetage Mâle conique préflonné - Cylindrique avec joint
---------------	---------------------------	--	------------------------	--------------------------	--	---

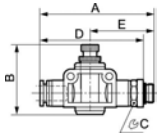

		A	B	C	D	E	DESIGNATION		REFERENCE
Régleur de débit mâle conique à vis - bidirectionnel - RPV BR									
							Tube Ø ext.	Filetage Gaz BSP	
		30	21.8	10	22.5	14.5	4 mm	R 1/8	RPV BR0400
		40	24	14	31	18.2	4 mm	R 1/4	RPV BR0401
		30	23	10	22.5	14.5	6 mm	R 1/8	RPV BR0600
		40	25.5	14	31	18.2	6 mm	R 1/4	RPV BR0601
		48	27.1	19	37	22	6 mm	R 3/8	RPV BR0602
		55.5	30.1	24	42.5	27.4	6 mm	R 1/2	RPV BR0603
		30	24.6	10	22.5	14.5	8 mm	R 1/8	RPV BR0800
		40	26.8	14	31	18.2	8 mm	R 1/4	RPV BR0801
		48	28.8	19	37	22	8 mm	R 3/8	RPV BR0802
		55.5	30.5	24	42.5	27.4	8 mm	R 1/2	RPV BR0803
		30	28.5	10	22.5	14.5	10 mm	R 1/8	RPV BR1000
		40	31	14	31	18.2	10 mm	R 1/4	RPV BR1001
		48	31	19	37	22	10 mm	R 3/8	RPV BR1002
		55.5	34	24	42.5	27.4	10 mm	R 1/2	RPV BR1003
		40	31.8	14	31	18.2	12 mm	R 1/4	RPV BR1201
		48	34	19	37	22	12 mm	R 3/8	RPV BR1202
55.5	35.8	24	42.5	27.4	12 mm	R 1/2	RPV BR1203		
Régleur de débit mâle cylindrique à vis - bidirectionnel - RPV BG									
							Tube Ø ext.	Filetage Gaz BSP	
		30	21.8	10	24	14.5	4 mm	G 1/8	RPV BG0400
		37.5	24	14	31	18.2	4 mm	G 1/4	RPV BG0401
		30	23	10	24	14.5	6 mm	G 1/8	RPV BG0600
		37.5	25.5	14	31	18.2	6 mm	G 1/4	RPV BG0601
		46.5	27.1	19	39	22	6 mm	G 3/8	RPV BG0602
		54.5	30.1	24	45.5	27.4	6 mm	G 1/2	RPV BG0603
		30	24.6	10	24	14.5	8 mm	G 1/8	RPV BG0800
		37.5	26.8	14	31	18.2	8 mm	G 1/4	RPV BG0801
		46.5	28.8	19	39	22	8 mm	G 3/8	RPV BG0802
		54.5	30.5	24	45.5	27.4	8 mm	G 1/2	RPV BG0803
		30	28.5	10	24	14.5	10 mm	G 1/8	RPV BG1000
		37.5	31	14	31	18.2	10 mm	G 1/4	RPV BG1001
		46.5	31	19	39	22	10 mm	G 3/8	RPV BG1002
		54.5	34	24	45.5	27.4	10 mm	G 1/2	RPV BG1003
		37.5	31.8	14	31	18.2	12 mm	G 1/4	RPV BG1201
		46.5	34	19	39	22	12 mm	G 3/8	RPV BG1202
54.5	35.8	24	45.5	27.4	12 mm	G 1/2	RPV BG1203		
Régleur de débit mâle cylindrique à vis - bidirectionnel - RPV BG									
							Tube Ø ext.	Filetage métrique	
		26	19.7	8	22	10	4 mm	M5	RPV BG04M5
		26	22.5	8	22	10	6 mm	M5	RPV BG06M5

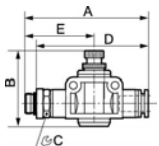
RACCORDS INSTANTANES POLYMERE REGLEURS DE DEBITS

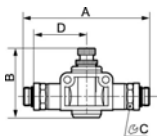
Fluide Air	Température 0°C à 60°C	Matière Corps: Polymère - Filetage: laiton nickelé	Pression 0 à 10 bar	Compatibilité PA - PU	Diamètre Tubes: Ø ext. 4 à 12 mm	Filetage Mâle conique préfileté - Cylindrique avec joint
---------------	---------------------------	--	------------------------	--------------------------	--	---

		A	B	C	D	E	DESIGNATION		REFERENCE
Régleur de débit unidirectionnel - Tube/Filetage mâle cylindrique - RPL PG									
							Tube Ø ext.	Filetage Gaz BSP	
		54.1	30	12	48.6	30.1	4 mm	G 1/8	RPL PG0400
		55.5	43	12	50	31	6 mm	G 1/8	RPL PG0600
		56	43	14	50	31.5	6 mm	G 1/4	RPL PG0601
		61.8	47	14	56.3	34.3	8 mm	G 1/8	RPL PG0800
		61.8	47	14	55.8	34.3	8 mm	G 1/4	RPL PG0801
		63.3	47	17	56.8	35.8	8 mm	G 3/8	RPL PG0802
		70.9	54	17	64.9	39.4	10 mm	G 1/4	RPL PG1001
		70.9	54	17	64.4	39.4	10 mm	G 3/8	RPL PG1002
		71.5	54	21	63.5	40	10 mm	G 1/2	RPL PG1003
		81.7	59	19	75.7	44.2	12 mm	G 1/4	RPL PG1201
		81.2	59	19	74.7	43.7	12 mm	G 3/8	RPL PG1202
		82.7	59	21	74.7	45.2	12 mm	G 1/2	RPL PG1203
Régleur de débit unidirectionnel - Filetage mâle cylindrique/Tube - RPL TG									
							Tube Ø ext.	Filetage Gaz BSP	
		54.1	30	12	48.6	30.1	4 mm	G 1/8	RPL TG0400
		55.5	43	12	50	31	6 mm	G 1/8	RPL TG0600
		56	43	14	50	31.5	6 mm	G 1/4	RPL TG0601
		61.8	47	14	56.3	34.3	8 mm	G 1/8	RPL TG0800
		61.8	47	14	55.8	34.3	8 mm	G 1/4	RPL TG0801
		63.3	47	17	56.8	35.8	8 mm	G 3/8	RPL TG0802
		70.9	54	17	64.9	39.4	10 mm	G 1/4	RPL TG1001
		70.9	54	17	64.4	39.4	10 mm	G 3/8	RPL TG1002
		71.5	54	21	63.5	40	10 mm	G 1/2	RPL TG1003
		81.7	59	19	75.7	44.2	12 mm	G 1/4	RPL TG1201
		81.2	59	19	74.7	43.7	12 mm	G 3/8	RPL TG1202
		82.7	59	21	74.7	45.2	12 mm	G 1/2	RPL TG1203
Régleur de débit unidirectionnel - Filetage mâle cylindrique/ Filetage mâle cylindrique - RPL DG									
							Filetage Gaz BSP	Filetage Gaz BSP	
		49	43	12	19		G 1/8	G 1/8	RPL DG0000
		55	43	14	21.5		G 1/4	G 1/4	RPL DG0101
		63	43	17	25		G 3/8	G 3/8	RPL DG0202
		75	43	21	29.5		G 1/2	G 1/2	RPL DG0303

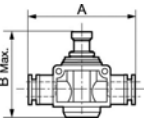
RACCORDS INSTANTANES POLYMERE REGLEURS DE DEBITS

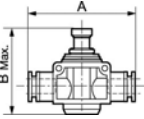
Fluide Air	Température 0°C à 60°C	Matière Corps: Polymère - Filetage: laiton nickelé	Pression 0 à 10 bar	Compatibilité PA - PU	Diamètre Tubes: Ø ext. 4 à 12 mm	Filetage Mâle conique prétéflonné - Cylindrique avec joint			
		A	B	C	D	E	DESIGNATION	REFERENCE	
Régleur de débit unidirectionnel - Tube/Tube - RPL ET									
							Tube Ø ext.		
		38	29					4 mm	RPL ET0404
		49	43					6 mm	RPL ET0606
		55.1	48					8 mm	RPL ET0808
		63	54					10 mm	RPL ET1010
		75	58					12 mm	RPL ET1212
Régleur de débit bidirectionnel - Tube/Tube - RPO ET									
							Tube Ø ext.		
		48	31					Ø 4 mm	RPO ET0404
		49	46					Ø 6 mm	RPO ET0606
		55.1	50					Ø 8 mm	RPO ET0808
		63	53					Ø 10 mm	RPO ET1010
		75	63					Ø 12 mm	RPO ET1212

RACCORDS INSTANTANES POLYMERE MICRO CONEX

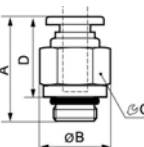
Diamètre Tubes: Ø ext. 3 - 4 - 6 mm	Filetage G 1/8 - M3 - M5	Température 0°C à 60° C	Fluide Air	Pression 0 à 10 bar	Matière Corps: Polymère - Filetage: laiton nickelé	Compatibilité PU - PA				
		A	B	C	D	E	DESIGNATION	REFERENCE		
Micro raccord droit mâle cylindrique - RCD MG										
							Tube Ø ext.	Filetage Gaz BSP		
		15	11.5	10	10			4 mm	G 1/8	RCD MG0400
		17.5	11.5	10	12.5			6 mm	G 1/8	RCD MG0600







RACCORDS INSTANTANES POLYMERE MICRO CONEX

Diamètre Tubes: Ø ext. 3 - 4 - 6 mm	Filetage G 1/8 - M3 - M5	Température 0°C à 60° C	Fluide Air	Pression 0 à 10 bar	Matière Corps: Polymère - Filetage: laiton nickelé	Compatibilité PU - PA
---	-----------------------------	----------------------------	---------------	------------------------	--	--------------------------

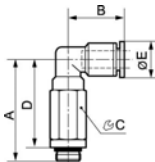
		A	B	C	D	E	DESIGNATION		REFERENCE
Micro raccord droit mâle cylindrique - RCD MG									
		15	9.2	8	12		Tube Ø ext.	Filetage métrique	
		15	9.2	8	11.5		3 mm	M3	RCD MG03M3
		17	9.2	8	14		3 mm	M5	RCD MG03M5
		17.5	9.2	8	14		4 mm	M3	RCD MG04M3
		20	11.5	10	16.5		4 mm	M5	RCD MG04M5
							6 mm	M5	RCD MG06M5
Micro raccord droit femelle cylindrique - RCD FG									
		22.7	14	12	13.7		Tube Ø ext.	Filetage Gaz BSP	
		22.7	14	12	13.7		4 mm	G 1/8	RCD FG0400
							6 mm	G 1/8	RCD FG0600
Micro raccord droit femelle cylindrique - RCD FG									
		15.7	9.5	8	11.2		Tube Ø ext.	Filetage métrique	
		16.2	9.5	8	11.2		3 mm	M3	RCD FG03M3
		18.2	9.5	8	13.7		3 mm	M5	RCD FG03M5
		18.7	9.5	8	13.7		4 mm	M3	RCD FG04M3
		20.2	12	10	15.2		4 mm	M5	RCD FG04M5
							6 mm	M5	RCD FG06M5
Micro coude 90° mâle cylindrique - RCC MG									
		16.5	15.7	10	9	8.5	Tube Ø ext.	Filetage Gaz BSP	
		18.5	16.7	10	11	10.5	4 mm	G 1/8	RCC MG0400
							6 mm	G 1/8	RCC MG0600
Micro coude 90° mâle cylindrique - RCC MG									
		14.5	12.8	8	11.5	7	Tube Ø ext.	Filetage métrique	
		15	12.8	8	11.5	7	3 mm	M3	RCC MG03M3
		12.5	15.7	8	9.5	8.5	3 mm	M5	RCC MG03M5
		13	15.7	8	9.5	8.5	4 mm	M3	RCC MG04M3
		18	16.7	10	14.5	10.5	4 mm	M5	RCC MG04M5
							6 mm	M5	RCC MG06M5

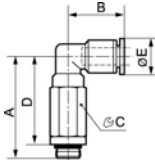

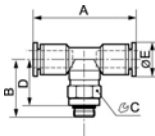

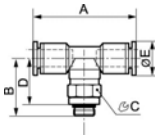

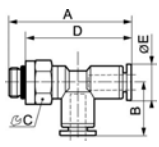

RACCORDS INSTANTANES POLYMERE MICRO CONEX

Diamètre Tubes: Ø ext. 3 - 4 - 6 mm	Filetage G 1/8 - M3 - M5	Température 0°C à 60° C	Fluide Air	Pression 0 à 10 bar	Matière Corps: Polymère - Filetage: laiton nickelé	Compatibilité PU - PA
---	-----------------------------	----------------------------	---------------	------------------------	--	--------------------------

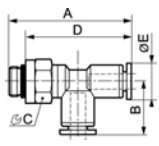
		A	B	C	D	E	DESIGNATION		REFERENCE
Micro coude 90° mâle cylindrique long - RCC LG									
		35	15.7	10	27.5	8.5	Tube Ø ext. 4 mm	Filetage Gaz BSP G 1/8	RCC LG0400
		37.5	16.7	10	30	10.5	6 mm	G 1/8	RCC LG0600
Micro coude 90° mâle cylindrique long - RCC LG									
		22.5	12.8	8	19.5	7	Tube Ø ext. 3 mm	Filetage métrique M3	RCC LG03M3
		23.5	12.8	8	20	7	3 mm	M5	RCC LG03M5
		27	15.7	8	24	8.5	4 mm	M3	RCC LG04M3
		28	15.7	8	24.5	8.5	4 mm	M5	RCC LG04M5
		32	16.5	10	28.5	10.5	6 mm	M5	RCC LG06M5
Micro té mâle cylindrique au centre - RCT CG									
		27.6	19.2	10	11.7	8.5	Tube Ø ext. 4 mm	Filetage Gaz BSP G 1/8	RCT CG0400
		35	21.7	10	14.2	10.5	6 mm	G 1/8	RCT CG0600
Micro té mâle cylindrique au centre - RCT CG									
		23.2	14.5	8	11.5	7	Tube Ø ext. 3 mm	Filetage métrique M3	RCT CG03M3
		23.2	15	8	11.5	7	3 mm	M5	RCT CG03M5
		27.6	15.7	8	12.7	8.5	4 mm	M3	RCT CG04M3
		27.6	16.2	8	12.7	8.5	4 mm	M5	RCT CG04M5
		27	21.2	10	17.7	10.5	6 mm	M5	RCT CG06M5

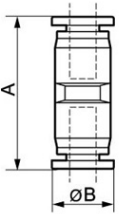

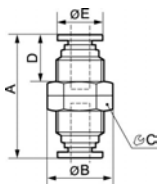

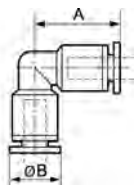

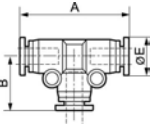

RACCORDS INSTANTANES POLYMERE MICRO CONEX

Diamètre Tubes: Ø ext. 3 - 4 - 6 mm	Filetage G 1/8 - M3 - M5	Température 0°C à 60° C	Fluide Air	Pression 0 à 10 bar	Matière Corps: Polymère - Filetage: laiton nickelé	Compatibilité PU - PA
---	-----------------------------	----------------------------	---------------	------------------------	--	--------------------------

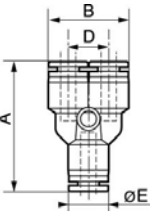
		A	B	C	D	E	DESIGNATION	REFERENCE	
Micro té mâle cylindrique latéral - RCT AG									
		33	13.8	10	25.5	8.5	Tube Ø ext. 4 mm	Filetage Gaz BSP G 1/8	RCT AG0400
		39.2	17.5	10	31.7	10.5	6 mm	G 1/8	RCT AG0600
Micro té mâle cylindrique latéral - RCT AG									
		26.1	11.6	8	23.1	7	Tube Ø ext. 3 mm	Filetage métrique M3	RCT AG03M3
		26.6	11.6	8	23.1	7	3 mm	M5	RCT AG03M5
		29.5	13.8	8	26.5	8.5	4 mm	M3	RCT AG04M3
		30	13.8	8	26.5	8.5	4 mm	M5	RCT AG04M5
		34.7	13.5	10	31.2	10.5	6 mm	M5	RCT AG06M5
Micro union égale - RCU ET									
		20.5	7				Tube Ø ext. 3 mm	RCU ET0303	
		23.4	8.5				4 mm	RCU ET0404	
		28	10.5				6 mm	RCU ET0606	
Micro union égale traversée de cloison - RCU TT									
		23.6	12	10	9	7.2	Tube Ø ext. 3 mm	RCU TT0303	
		26.2	14	12	9.5	9.5	4 mm	RCU TT0404	
		26.2	16.5	14	9.5	10.7	6 mm	RCU TT0606	
Micro coude 90° égal - RCC ET									
		11.6	7				Tube Ø ext. 3 mm	RCC ET0303	
		15.7	8.5				4 mm	RCC ET0404	
		17.8	10.5				6 mm	RCC ET0606	

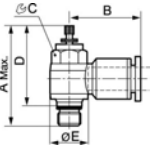

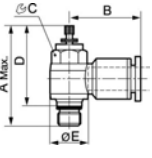

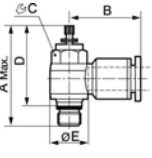
RACCORDS INSTANTANES POLYMERE MICRO CONEX

Diamètre Tubes: Ø ext. 3 - 4 - 6 mm	Filetage G 1/8 - M3 - M5	Température 0°C à 60° C	Fluide Air	Pression 0 à 10 bar	Matière Corps: Polymère - Filetage: laiton nickelé	Compatibilité PU - PA
---	-----------------------------	----------------------------	---------------	------------------------	--	--------------------------

		A	B	C	D	E	DESIGNATION	REFERENCE	
Micro té égal - RCT ET									
							Tube Ø ext.		
		23.2	11.6			7	3 mm	RCT ET0303	
		27.6	13.8			8.5	4 mm	RCT ET0404	
		37	18.5			10.5	6 mm	RCT ET0606	
Micro Y égal - RCY ET									
							Tube Ø ext.		
		29	17		8.5	8.5	4 mm	RCY ET0404	
		32	21		10.5	10.5	6 mm	RCY ET0606	
Micro régulateur de débit mâle cylindrique à molette - admission - RCM IG									
							Tube Ø ext.	Filetage métrique	
		32	15.2	8	28.5	10	3 mm	M5	RCM IG03M5
		32	18	8	28.5	10	4 mm	M5	RCM IG04M5
Micro régulateur de débit mâle cylindrique à molette - échappement - RCM OG									
							Tube Ø ext.	Filetage métrique	
		32	15.2	8	28.5	10	3 mm	M5	RCM OG03M5
		32	18	8	28.5	10	4 mm	M5	RCM OG04M5
Micro régulateur de débit mâle cylindrique à molette - bidirectionnel - RCM BG									
							Tube Ø ext.	Filetage métrique	
		32	15.2	8	28.5	10	3 mm	M5	RCM BG03M5
		32	18	8	28.5	10	4 mm	M5	RCM BG04M5

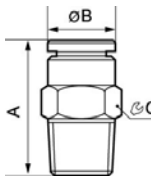

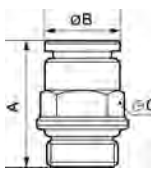

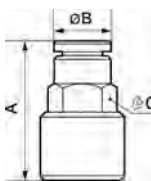
RACCORDS INSTANTANES METALLIQUES

Matière Laiton nickelé	Compatibilité PA - PU - PE	Fluide Air, Eau	Pression -0.99 à 16 bar	Température -20°C à +80°C	Filetage Mâle conique préteflonné - Mâle cylindrique avec joint	Diamètre Tubes: Ø ext. 4 à 14 mm
---------------------------	-------------------------------	--------------------	----------------------------	------------------------------	--	--

		A	B	C	D	E	DESIGNATION		REFERENCE
Raccord droit mâle conique - RMD MR									
							Tube Ø ext.	Filetage Gaz BSP	
		20.5	9.8	10			4 mm	R 1/8	RMD MR0400
		24.5	11.6	12			6 mm	R 1/8	RMD MR0600
		26	11.6	14			6 mm	R 1/4	RMD MR0601
		28	13.5	14			8 mm	R 1/8	RMD MR0800
		27.5	13.5	14			8 mm	R 1/4	RMD MR0801
		27	13.5	17			8 mm	R 3/8	RMD MR0802
		34.5	15.5	17			10 mm	R 1/4	RMD MR1001
		30.3	15.5	17			10 mm	R 3/8	RMD MR1002
		31.5	17.8	19			12 mm	R 3/8	RMD MR1202
		34	17.8	22			12 mm	R 1/2	RMD MR1203
Raccord droit mâle cylindrique - RMD MG									
							Tube Ø ext.	Filetage Gaz BSP	
		20.5	9.8	11			4 mm	G 1/8	RMD MG0400
		22.3	9.8	12			4 mm	G 1/4	RMD MG0401
		27.4	11.6	13			6 mm	G 1/8	RMD MG0600
		26.8	11.6	13			6 mm	G 1/4	RMD MG0601
		28.5	13.5	14			8 mm	G 1/8	RMD MG0800
		27	13.5	15			8 mm	G 1/4	RMD MG0801
		28	13.5	15			8 mm	G 3/8	RMD MG0802
		33.5	15.6	17			10 mm	G 1/4	RMD MG1001
		30.5	15.6	17			10 mm	G 3/8	RMD MG1002
		31.5	15.6	17			10 mm	G 1/2	RMD MG1003
		34.5	17.8	19			12 mm	G 1/4	RMD MG1201
		36	17.8	19			12 mm	G 3/8	RMD MG1202
		33.5	17.8	21			12 mm	G 1/2	RMD MG1203
		38	19.8	23			14 mm	G 3/8	RMD MG1402
39.5	19.8	23			14 mm	G 1/2	RMD MG1403		
Raccord droit femelle cylindrique - RMD FG									
							Tube Ø ext.	Filetage Gaz BSP	
		27	9.8	10			4 mm	G 1/8	RMD FG0400
		30	11.6	13			6 mm	G 1/8	RMD FG0600
		32.5	11.6	13			6 mm	G 1/4	RMD FG0601
		30.5	13.5	14			8 mm	G 1/8	RMD FG0800
		32.5	13.5	14			8 mm	G 1/4	RMD FG0801
		35.5	15.6	17			10 mm	G 1/4	RMD FG1001

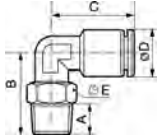

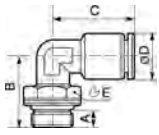

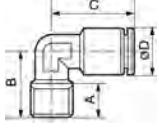

RACCORDS INSTANTANES METALLIQUES

Matière Laiton nickelé	Compatibilité PA - PU - PE	Fluide Air, Eau	Pression -0.99 à 16 bar	Température -20°C à +80°C	Filetage Mâle conique prétéflonné - Mâle cylindrique avec joint	Diamètre Tubes: Ø ext. 4 à 14 mm
---------------------------	-------------------------------	--------------------	----------------------------	------------------------------	--	--

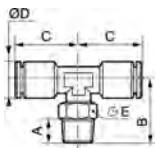
		A	B	C	D	E	DESIGNATION		REFERENCE
Coude 90° mâle conique orientable - RMC MR									
							Tube Ø ext.	Filetage Gaz BSP	
		6.2	22	21	10	12	4 mm	R 1/8	RMC MR0400
		8.5	27	21	10	16	4 mm	R 1/4	RMC MR0401
		6.2	22	24	11.8	12	6 mm	R 1/8	RMC MR0600
		11	26	26	11.6	16	6 mm	R 1/4	RMC MR0601
		8	23	26	13.5	12	8 mm	R 1/8	RMC MR0800
		11	26	26	13.5	16	8 mm	R 1/4	RMC MR0801
		11	30	28	13.5	19	8 mm	R 3/8	RMC MR0802
		11	28	30	15.6	16	10 mm	R 1/4	RMC MR1001
		12	31	30	15.6	19	10 mm	R 3/8	RMC MR1002
		12	32	33	17.8	19	12 mm	R 3/8	RMC MR1202
		14	33	34.5	19	22	12 mm	R 1/2	RMC MR1203
		14	34.5	36	19.8	22	14 mm	R 1/2	RMC MR1403
		Coude 90° mâle cylindrique orientable - RMC MG							
							Tube Ø ext.	Filetage Gaz BSP	
		6	21	21	10	13	4 mm	G 1/8	RMC MG0400
		8	17	21	9.8	16	4 mm	G 1/4	RMC MG0401
		6	20	25	11.6	13	6 mm	G 1/8	RMC MG0600
		8	25	25.5	12.5	16	6 mm	G 1/4	RMC MG0601
		6	23	26	13.5	13	8 mm	G 1/8	RMC MG0800
		8	24	26	13.5	16	8 mm	G 1/4	RMC MG0801
		9	30	28	13.5	19	8 mm	G 3/8	RMC MG0802
		8	26	30	15.6	16	10 mm	G 1/4	RMC MG1001
		9	30	30	15.6	19	10 mm	G 3/8	RMC MG1002
		11	32	32	15.6	22	10 mm	G 1/2	RMC MG1003
		8	38	34.5	19	16	12 mm	G 1/4	RMC MG1201
		9	31	33	17.8	19	12 mm	G 3/8	RMC MG1202
		11	32	33	17.8	22	12 mm	G 1/2	RMC MG1203
11	34	36	19.8	22	14 mm	G 1/2	RMC MG1403		
Coude 90° mâle conique fixe - RMC XR									
							Tube Ø ext.	Filetage Gaz BSP	
		6.2	16	21	9.5		4 mm	R 1/8	RMC XR0400
		8	16	24	11.6		6 mm	R 1/8	RMC XR0600
		10	18	23	11.6		6 mm	R 1/4	RMC XR0601
		8	17	26	13.5		8 mm	R 1/8	RMC XR0800
		8.5	20	26	14		8 mm	R 1/4	RMC XR0801
		8.5	22	30.5	14		10 mm	R 1/4	RMC XR1001

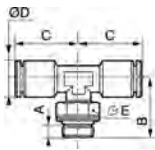

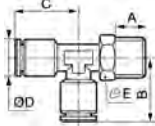

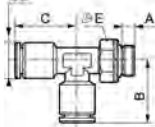

RACCORDS INSTANTANES METALLIQUES

Matière Laiton nickelé	Compatibilité PA - PU - PE	Fluide Air, Eau	Pression -0.99 à 16 bar	Température -20°C à +80°C	Filetage Mâle conique prétéflonné - Mâle cylindrique avec joint	Diamètre Tubes: Ø ext. 4 à 14 mm
---------------------------	-------------------------------	--------------------	----------------------------	------------------------------	--	--

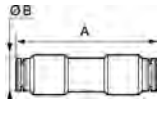

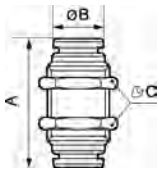

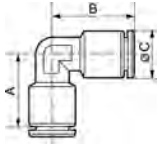
		A	B	C	D	E	DESIGNATION		REFERENCE
Té mâle conique au centre orientable - RMT CR									
							Tube Ø ext.	Filetage Gaz BSP	
		8	21.5	21	9.8	12	4 mm	R 1/8	RMT CR0400
		11	25	21	9.8	16	4 mm	R 1/4	RMT CR0401
		8	21.5	24	11.6	12	6 mm	R 1/8	RMT CR0600
		11	26	26	11.6	16	6 mm	R 1/4	RMT CR0601
		8	23	26	13.5	12	8 mm	R 1/8	RMT CR0800
		11	26	26	13.5	16	8 mm	R 1/4	RMT CR0801
							8 mm	R 3/8	RMT CR0802
		11	28.5	30.5	15.6	16	10 mm	R 1/4	RMT CR1001
		11	30.5	30.5	15.6	19	10 mm	R 3/8	RMT CR1002
Té mâle cylindrique au centre orientable - RMT CG									
							Tube Ø ext.	Filetage Gaz BSP	
		6	20.5	21	9.8	13	4 mm	G 1/8	RMT CG0400
		8	23	21	9.8	16	4 mm	G 1/4	RMT CG0401
		6	20.5	24	11.6	13	6 mm	G 1/8	RMT CG0600
		8	24	26	11.6	16	6 mm	G 1/4	RMT CG0601
		6	22	26	13.5	13	8 mm	G 1/8	RMT CG0800
		8	24	26	13.5	16	8 mm	G 1/4	RMT CG0801
		9	30	27.5	13.5	19	8 mm	G 3/8	RMT CG0802
		8	26.5	30.5	15.6	16	10 mm	G 1/4	RMT CG1001
		9	29.5	30.5	15.6	19	10 mm	G 3/8	RMT CG1002
		9	31.5	34	19	19	12 mm	G 3/8	RMT CG1202
		11	32	33	17.8	22	12 mm	G 1/2	RMT CG1203
		11	34.5	37	19.8	22	14 mm	G 1/2	RMT CG1403
Té mâle latéral conique orientable - RMT AR									
			22.5	21	9.5		Tube Ø ext.	Filetage Gaz BSP	
		8	24	24	11.6	12	6 mm	R 1/8	RMT AR0600
		11	25	26	11.6	16	6 mm	R 1/4	RMT AR0601
		8	27.5	27.5	14.5	12	8 mm	R 1/8	RMT AR0800
			27.5	27.5	14.5		8 mm	R 1/4	RMT AR0801
		11	30.5	30.5	15.6	16	10 mm	R 1/4	RMT AR1001
		11	30.5	30.5	15.6	19	10 mm	R 3/8	RMT AR1002
			35.5	35.5	19		12 mm	R 3/8	RMT AR1202
		14	34.5	34.5	19	22	12 mm	R 1/2	RMT AR1203
		Té mâle latéral cylindrique orientable - RMT AG							
			22.5	22.5	9.5	15	Tube Ø ext.	Filetage Gaz BSP	
		6	24	24	11.6	13	6 mm	G 1/8	RMT AG0600
		8	25	26	11.6	16	6 mm	G 1/4	RMT AG0601
		6	26	26	13.5	13	8 mm	G 1/8	RMT AG0800
		8	26	26	13.5	16	8 mm	G 1/4	RMT AG0801
		8	30.5	30.5	15.6	16	10 mm	G 1/4	RMT AG1001
		9	30.5	30.5	15.6	19	10 mm	G 3/8	RMT AG1002
		9	33	33	17.8	19	12 mm	G 3/8	RMT AG1202
		11	34.5	34.5	19	22	12 mm	G 1/2	RMT AG1203

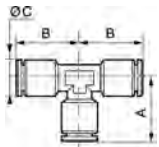
RACCORDS INSTANTANES METALLIQUES

Matière Laiton nickelé	Compatibilité PA - PU - PE	Fluide Air, Eau	Pression -0.99 à 16 bar	Température -20°C à +80°C	Filetage Mâle conique prétreffonné - Mâle cylindrique avec joint	Diamètre Tubes: Ø ext. 4 à 14 mm
---------------------------	-------------------------------	--------------------	----------------------------	------------------------------	---	--

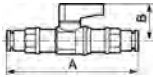
		A	B	C	D	E	DESIGNATION	REFERENCE	
Union égale - RMU ET									
							Tube Ø ext.		
		32.5	9.8					4 mm	RMU ET0404
		40	11.6					6 mm	RMU ET0606
		41	13.5					8 mm	RMU ET0808
		42	15.6					10 mm	RMU ET1010
		50	17.8					12 mm	RMU ET1212
		55.5	19.8					14 mm	RMU ET1414
Union traversée de cloison - RMU TT									
							Tube Ø ext.		
		33	9.8	16				4 mm	RMU TT0404
		40	11.6	17				6 mm	RMU TT0606
		41	13.5	20				8 mm	RMU TT0808
		47	15.6	24				10 mm	RMU TT1010
							12 mm	RMU TT1212	
Coude égal 90° - RMC ET									
							Tube Ø ext.		
		21	21	9.8				4 mm	RMC ET0404
		22	22	11.6				6 mm	RMC ET0606
		26	26	13.5				8 mm	RMC ET0808
		30	30	15.6				10 mm	RMC ET1010
		34.5	34.5	17.8				12 mm	RMC ET1212
		37	37	19.8				14 mm	RMC ET1414
Té égal - RMT ET									
							Tube Ø ext.		
		21	21	9.8				4 mm	RMT ET0404
		24	24	11.6				6 mm	RMT ET0606
		26	26	13.5				8 mm	RMT ET0808
		30.5	30.5	15.6				10 mm	RMT ET1010
		33.5	33.5	17.8				12 mm	RMT ET1212
		37	37	19.8				14 mm	RMT ET1414

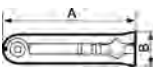
RACCORDS INSTANTANES METALLIQUES

Matière Laiton nickelé	Compatibilité PA - PU - PE	Fluide Air, Eau	Pression -0.99 à 16 bar	Température -20°C à +80°C	Filetage Mâle conique prétéflonné - Mâle cylindrique avec joint	Diamètre Tubes: Ø ext. 4 à 14 mm		
Micro vanne - Tubes égaux - RMF ET		A	B	C	D	E	DESIGNATION	REFERENCE
 	Tube Ø ext.							
	69	20					4 mm	RMF ET0404
	81	20					6 mm	RMF ET0606
	83	20					8 mm	RMF ET0808
Coupe tube - R22 CT							Spécialement conçu pour obtenir une coupe parfaite à 90°.	
 	112	28					Coupe tube	R22 CT
	Outil de déconnexion - R22							Pour démontage en série
	141	14					Outil de déconnexion	R22 TD

RACCORDS INSTANTANES INOX

Matière Inox 316	Joint Viton	Passage Tubes Ø ext. 4, 6, 8 mm	Fluide Air, Eau, Gaz inertes			Pression -0.99 à 16 bar	Température -20°C à +120°C	Utilisation alimentaire Chimie - Portuaire
---------------------	----------------	---------------------------------------	---------------------------------	--	--	----------------------------	-------------------------------	---

		A	B	C	D	E	DESIGNATION	REFERENCE	
Raccord droit mâle conique - RX1									
							Tube Ø ext.	Filetage Gaz BSP	
		20.5	7.5	10			4 mm	R 1/8	RX1 418
		21.5	7.5	12			6 mm	R 1/8	RX1 618
		24.5	11	14			6 mm	R 1/4	RX1 614
		27	7.5	14			8 mm	R 1/8	RX1 818
		26.5	11	14			8 mm	R 1/4	RX1 814
24.5	11.5	17			8 mm	R 3/8	RX1 838		
CoUDE mâle 90° cylindrique orientable - RX5									
							Tube Ø ext.	Filetage Gaz BSP	
		22	20	5	10	13	4 mm	G 1/8	RX5 418
		23.5	20	5	10	13	6 mm	G 1/8	RX5 618
		23.5	22.5	7	10	17	6 mm	R 1/4	RX5 614
		27.5	21.5	5	13	13	8 mm	G 1/8	RX5 818
		27.5	24	7	13	17	8 mm	G 1/4	RX5 814
27.5	27.5	8	13	19	8 mm	G 3/8	RX5 838		
CoUDE égal 90° - RX6									
							Tube Ø ext.		
		22	10				4 mm		RX6 4
		23.5	10				6 mm		RX6 6
27.5	13				8 mm			RX6 8	
Té mâle au centre cylindrique orientable - RX7									
							Tube Ø ext.	Filetage Gaz BSP	
		44	20	5	10	13	4 mm	G 1/8	RX7 418
		47	20	5	10	13	6 mm	G 1/8	RX7 618
		47	22.5	7	10	17	6 mm	G 1/4	RX7 614
		55	21.5	5	13	13	8 mm	G 1/8	RX7 818
		55	24.5	7	13	17	8 mm	G 1/4	RX7 814
55	27.5	8	13	19	8 mm	G 3/8	RX7 838		
Té égal - RX9									
							Tube Ø ext.		
		44	22	10			4 mm		RX9 4
		47	23.5	10			6 mm		RX9 6
55	27.5	13			8 mm			RX9 8	

ACCESSOIRES DE LIGNE

Facilité d'emploi Mise en place simple	Matière Laiton et laiton nickelé	Sécurité du réseau	Applications multiples Automatismes et réseaux
---	-------------------------------------	-----------------------	---

		A	B	C	DESIGNATION	REFERENCE	
Clapet anti-retour							
					Pression maxi : 10 bar Température maxi : 130°C		
		35	15.5	13	G 1/8	Laiton nickelé	A24 18
		41	20	17	G 1/4	Laiton nickelé	A24 14
		46	20	23	G 3/8	Laiton	A24 38
		50	25	28	G 1/2	Laiton	A24 12
Clapet anti-retour							
					Pression maxi : 25 bar Température maxi : 110°C		
		63.5	42	32	G 3/4	Laiton	A24 34
Soupape d'échappement rapide							
					Pression maxi : 10 bar Température maxi : 70°C		
		42	28	14	G 1/8	Laiton nickelé	A25 18
		55	33	19	G 1/4	Laiton nickelé	A25 14
		61	38	22	G 3/8	Laiton nickelé	A25 38
		73	43	26	G 1/2	Laiton nickelé	A25 12
90	49	32	G 3/4	Laiton nickelé	A25 34		
Limiteur de débit							
		69	49	15	Réducteur de débit d'air par diminution du diamètre de passage Filetage G 1/4 mâle/femelle	RG DT14	
Purge manuelle							
		23	15		Purge manuelle G 1/8	MA 18	
		23	15		Purge manuelle G 1/4	MA 14	
		26	17		Purge manuelle G 3/8	MA 38	

ACCESSOIRES DE LIGNE SILENCIEUX D'ECHAPPEMENT

Pression Max. 12 bar		Niveau sonore Abaissement du niveau sonore		Aérosol Elimination des aérosols d'huile		Air propre Exempt de nuisance		Matière Filtre bronze fritté sauf réf. PPP		Applications multiples Automatismes et réseaux	
		A	B	C	D	DESIGNATION		REFERENCE			
Silencieux d'échappement mâle cylindrique											
		21		8	16.5	M5 x 0,8	Filtre bronze fritté	PPS M5			
		28		13	22	G 1/8	Filtre bronze fritté	PPS 18			
		33.5		16	26	G 1/4	Filtre bronze fritté	PPS 14			
		42		19	34	G 3/8	Filtre bronze fritté	PPS 38			
		53		24	43	G 1/2	Filtre bronze fritté	PPS 12			
		50		30	40	G 3/4	Filtre bronze fritté	PPS 34			
Silencieux d'échappement mâle cylindrique											
		21	11		16	G 1/8	Filtre bronze fritté	PPB 18			
		27	14		19	G 1/4	Filtre bronze fritté	PPB 14			
		37	19		28	G 3/8	Filtre bronze fritté	PPB 38			
		42	22		33	G 1/2	Filtre bronze fritté	PPB 12			
		55.5	28.5		40	G 3/4	Filtre bronze fritté	PPB 34			
		70	38		54	G 1	Filtre bronze fritté	PPB 01			
Silencieux d'échappement mâle plat cylindrique											
		9		8	5	M5 x 0,8	Filtre bronze fritté	PPC M5			
		13		13	7	G 1/8	Filtre bronze fritté	PPC 18			
		16		16	8	G 1/4	Filtre bronze fritté	PPC 14			
		16.5		19	8.5	G 3/8	Filtre bronze fritté	PPC 38			
		18		24	8	G 1/2	Filtre bronze fritté	PPC 12			
		18		30	8.5	G 3/4	Filtre bronze fritté	PPC 34			
Silencieux d'échappement plat réducteur de débit mâle cylindrique - A26											
		22		12	14.5	G 1/8	Filtre bronze fritté	A26 18			
		26		15	16.5	G 1/4	Filtre bronze fritté	A26 14			
		29		22	18.5	G 3/8	Filtre bronze fritté	A26 38			
Silencieux d'échappement mâle réducteur de débit cylindrique - A27											
		43		16	35.5	G 1/8	Filtre bronze fritté	A27 18			
		43		16	35.5	G 1/4	Filtre bronze fritté	A27 14			
		58		22	47.5	G 3/8	Filtre bronze fritté	A27 38			
Silencieux d'échappement mâle cylindrique - PPP											
		22	6.5		16.5	M5	Polyéthylène	PPP M5			
		34	12.5		27	G 1/8	Polyéthylène	PPP 18			
		38	16.5		30	G 1/4	Polyéthylène	PPP 14			
		67.5	18.5		56.5	G 3/8	Polyéthylène	PPP 38			
		76	23.5		65	G 1/2	Polyéthylène	PPP 12			
		133	39.5		117	G 3/4	Polyéthylène	PPP 34			
		160	50		140	G 1	Polyéthylène	PPP 01			

raccords laiton

RACCORDS À COMPRESSION ET RACCORDS À OLIVE

RACCORDS À COMPRESSION LAITON NICKELÉ :

- Montage du tube sur le guide conique du raccord
- Fixation par écrou
- Pour tubes polyuréthane et polyamide

► **Applications :**

- Air comprimé, eau, fluides inertes, huile
- Pression maximale : 15 bar

RACCORDS À OLIVE LAITON NICKELÉ :

- Raccord 3 pièces : corps, olive et écrou
- Pour tubes acier, aluminium, cuivre, polyuréthane et polyamide







► **Applications :**

- Air comprimé, eau, fluides inertes, huile
- Pression maximum : 130 bar

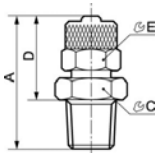

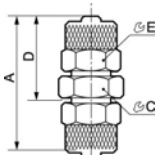
RACCORDS A COMPRESSION

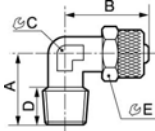
Raccord 2 pièces	Matière Laiton nickelé	Passage libre Eau, Air, Huile	Pression -0,9 à 20 bar	Température -20 °C à + 80 °C	Compatibilité PA - PU - PE - NYLON - PTFE - FEP
------------------	---------------------------	----------------------------------	---------------------------	---------------------------------	---

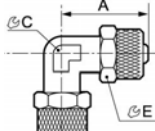
		A	B	C	D	E	DESIGNATION	REFERENCE	
Raccord droit mâle conique - RB1									
							Pour tube	Filetage Gaz BSP	
		26.5		12	18.5	12	Ø 6 x 4	R 1/8	RB1 618
		30		14	19	12	Ø 6 x 4	R 1/4	RB1 614
		26.5		12	18.5	14	Ø 8 x 6	R 1/8	RB1 818
		30		14	19	14	Ø 8 x 6	R 1/4	RB1 814
		31		17	19.5	14	Ø 8 x 6	R 3/8	RB1 838
		32		14	21	16	Ø 10 x 8	R 1/4	RB1 1014
		33		17	21.5	16	Ø 10 x 8	R 3/8	RB1 1038
		35		17	23.5	19	Ø 12 x 10	R 3/8	RB1 1238
Union égale - RB3									
							Pour tube		
		33		12	19	12	Ø 6 x 4		RB3 6
		30		12	27.5	12	Ø 8 x 6		RB3 8
		37		14	21.5	16	Ø 10 x 8		RB3 10
		42		17	19	19	Ø 12 x 10		RB3 12
Coude mâle 90° conique - RB5									
							Pour tube	Filetage Gaz BSP	
		17	22	9	7	12	Ø 6 x 4	R 1/8	RB5 618
		20	22	9	10	12	Ø 6 x 4	R 1/4	RB5 614
		18	23	12	8	14	Ø 8 x 6	R 1/8	RB5 818
		20	22	12	10	14	Ø 8 x 6	R 1/4	RB5 814
		21	21	9	12	16	Ø 8 x 6	R 3/8	RB5 838
		20.5	25	12	10	16	Ø 10 x 8	R 1/4	RB5 1014
		22	23	11	12	14	Ø 10 x 8	R 3/8	RB5 1038
	24	31	17	12	19	Ø 12 x 10	R 3/8	RB5 1238	
Coude égal - RB6									
							Pour tube		
		27.5		9		12	Ø 6 x 4		RB6 6
		29.5		12		14	Ø 8 x 6		RB6 8
		33.5		12		16	Ø 10 x 8		RB6 10





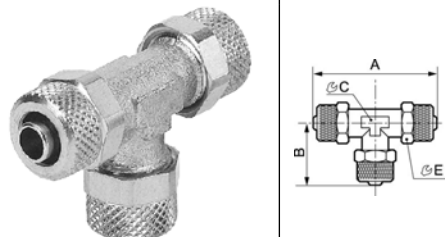
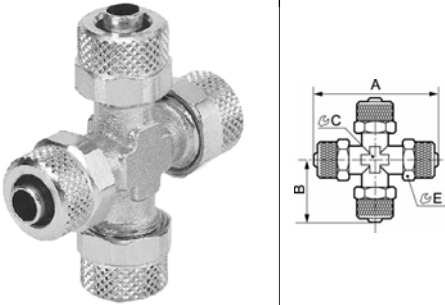

RACCORDS A COMPRESSION

Raccord 2 pièces	Matière Laiton nickelé	Passage libre Eau, Air, Huile	Pression -0,9 à 20 bar	Température -20 °C à + 80 °C	Compatibilité PA - PU - PE - NYLON - PTFE - FEP
------------------	---------------------------	----------------------------------	---------------------------	---------------------------------	---

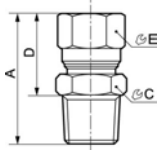
		A	B	C	D	E	DESIGNATION	REFERENCE	
Té mâle au centre conique - RB7									
							Pour tube	Filetage Gaz BSP	
		44	17	9	7	12	Ø 6 x 4	R 1/8	RB7 618
		44	20	9	10	12	Ø 6 x 4	R 1/4	RB7 614
		44	20	12	8	14	Ø 8 x 6	R 1/4	RB7 814
		50	21	12	10	16	Ø 10 x 8	R 1/4	RB7 1014
		50	22	12	10	16	Ø 10 x 8	R 3/8	RB7 1038
Té égal - RB9									
							Pour tube		
		45	22.5	9		12	Ø 6 x 4		RB9 6
		45	22.5	12		14	Ø 8 x 6		RB9 8
		51	25.5	12		16	Ø 10 x 8		RB9 10
		62	31	17		19	Ø 12 x 10		RB9 12
Croix égale - RB12									
							Pour tube		
		45	22.5	8		12	Ø 6 x 4		RB12 6
		45	22.5	10		14	Ø 8 x 6		RB12 8
		51	25.5	11		16	Ø 10 x 8		RB12 10

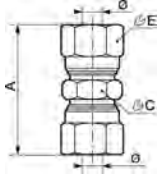

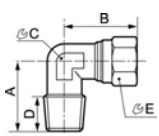

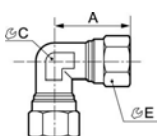

RACCORDS A OLIVE

Matière Corps et écrou : laiton nickelé Olive : laiton	Passage libre Eau, air, huile, fluides inertes	Pression -0,9 à 60 bar	Raccord 3 pièces	Compatibilité PA - PU - PE - NYLON - PTFE - FEP - CUIVRE	Température -40°C à +240°C
--	--	---------------------------	------------------	--	-------------------------------

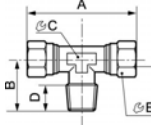
		A	B	C	D	E	DESIGNATION	REFERENCE	
Raccord droit mâle conique - RO1									
							Pour tube	Filetage Gaz BSP	
		27.5		10	19.5	10	Ø ext 4	R 1/8	RO1 418
		28		12	20	12	Ø ext 6	R 1/8	RO1 618
		31		14	20	12	Ø ext 6	R 1/4	RO1 614
		30		12	22	14	Ø ext 8	R 1/8	RO1 818
		33		14	22	14	Ø ext 8	R 1/4	RO1 814
		33.5		17	22	14	Ø ext 8	R 3/8	RO1 838
		38.5		17	27.5	19	Ø ext 10	R 1/4	RO1 1014
		39		17	27.5	19	Ø ext 10	R 3/8	RO1 1038
		38.5		19	27	22	Ø ext 12	R 3/8	RO1 1238
		42		22	28	22	Ø ext 12	R 1/2	RO1 1212
Union égale - RO3									
							Pour tube		
		35		10		10	Ø ext 4		RO3 4
		36		12		12	Ø ext 6		RO3 6
		39		14		14	Ø ext 8		RO3 8
		50		17		19	Ø ext 10		RO3 10
50		19		22	Ø ext 12		RO3 12		
Coude mâle 90° conique - RO5									
							Pour tube	Filetage Gaz BSP	
		16	21.5	9	8	10	Ø ext. 4	R 1/8	RO5 418
		16	22	9	8	12	Ø ext. 6	R 1/8	RO5 618
		20	23.5	11	11	12	Ø ext. 6	R 1/4	RO5 614
		17	24	11	8	14	Ø ext. 8	R 1/8	RO5 818
		20	24	11	11	14	Ø ext. 8	R 1/4	RO5 814
		23.5	27	13	12	14	Ø ext. 8	R 3/8	RO5 838
		22.5	32	13	11	19	Ø ext. 10	R 1/4	RO5 1014
		23.5	32	13	12	19	Ø ext. 10	R 3/8	RO5 1038
		24	33.5	15	11.5	22	Ø ext. 12	R 3/8	RO5 1238
30	38	20	13	22	Ø ext. 12	R 1/2	RO5 1212		
Coude égal - RO6									
							Pour tube		
		21.5		9		10	Ø ext 4		RO6 4
		22		9		12	Ø ext 6		RO6 6
		24		11		14	Ø ext 8		RO6 8
		32		13		19	Ø ext 10		RO6 10
33.5		15		22	Ø ext 12		RO6 12		

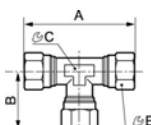
RACCORDS A OLIVE

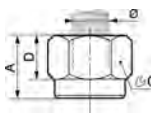
Matière Corps et écrou : laiton nickelé Olive : laiton	Passage libre Eau, air, huile, fluides inertes	Pression -0,9 à 60 bar	Raccord 3 pièces	Compatibilité PA - PU - PE - NYLON - PTFE - FEP - CUIVRE	Température -40°C à +240°C
--	--	---------------------------	------------------	--	-------------------------------

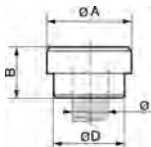
		A	B	C	D	E	DESIGNATION	REFERENCE	
Té mâle conique au centre - RO7									
							Pour tube	Filetage Gaz BSP	
		41	14	8	8	10	Ø ext. 4	R 1/8	RO7 418
		44	16	9	8	12	Ø ext. 6	R 1/8	RO7 618
		48	20	11	10	12	Ø ext. 6	R 1/4	RO7 614
		64	17	11	8	14	Ø ext. 8	R 1/8	RO7 818
		67	20	11	10	14	Ø ext. 8	R 1/4	RO7 814
Té égal - RO9									
							Pour tube		
		43	21.5	9		10	Ø ext 4		RO9 4
		44	22	9		12	Ø ext 6		RO9 6
		48	24	11		14	Ø ext 8		RO9 8
		64	32	13		19	Ø ext 10		RO9 10
		67	33.5	15		22	Ø ext 12		RO9 12
Ecrou - RO E									
							Pour tube		
		11		10	8		Ø ext 4		RO E4
		11.5		12	9		Ø ext 6		RO E6
		13		14	10		Ø ext 8		RO E8
		15.5		19	14		Ø ext 10		RO E10
		15.5		22	14		Ø ext 12		RO E12
Olive - RO O									
							Pour tube		
		5.5	6		5		Ø ext 4		RO O4
		8	7		7.5		Ø ext 6		RO O6
		10	7		9.5		Ø ext 8		RO O8
		13	10		12		Ø ext 10		RO O10
		15	10		14		Ø ext 12		RO O12

gamme cpi

RACCORDS RAPIDES POUR CIRCUITS DE REFROIDISSEMENT

RACCORDS RAPIDES CPI POUR MOULES SUR PRESSE À INJECTER

- ▶ Rapides, automatiques et fiables, les branchements et débranchements s'effectuent d'une seule main
- ▶ Les deux diamètres disponibles, 8 mm & 12 mm, passage intégral, offrent un débit maximal pour un faible encombrement extérieur
- ▶ La conception en passage libre élimine tout risque d'entartrage

LES PRISES

Les prises (parties femelles) peuvent être encastrées totalement dans les moules pour en faciliter la manipulation et le stockage.



- ▶ Les prises rallonges lisses ou filetées, solides et rigides se positionnent facilement dans les moules.
- ▶ Les prises droites préteflonnées assurent une étanchéité et une propreté immédiate.
- ▶ Des bagues, de couleur rouge ou bleue, sont disponibles pour identifier les flux.

LES FICHES

Les fiches (parties mâles) sont montées sur les flexibles des presses à injecter.













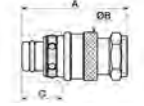

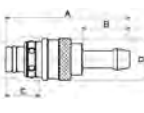

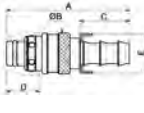

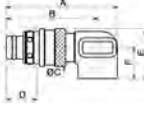

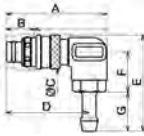
- ▶ La bague de verrouillage moletée facilite la prise en main de la fiche.
- ▶ Le remplacement du joint est facile et rapide.

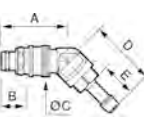
APPLICATIONS	CONSTRUCTION
> Régulation de la température des moules sur presse à injecter les thermoplastiques, le zamak et autres alliages aluminium.	> Prises, rallonges et fiches en laiton nickelé
> Circuits d'eau froide, d'eau réfrigérée ou d'eau chaude.	> Joint Nitrile
	> Ressort et billes en inox 18/8
	> Connexions : - Ø 8 mm 6 billes - Ø 12 mm 6 billes

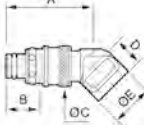

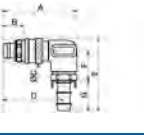

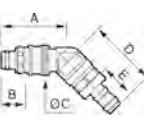

PRISES D'IMPLANTATION Ø 8 SUR MOULES

Passage 8 mm	Passage libre	Pression 10 bar			Température -15°C à +90°C			Matière Laiton nickelé		Débit en l/min DP 0,50 bar = 30 l/min	
		A	B	C	D	E	F	G	H	DESIGNATION	REFERENCE
Prise droite fileté mâle conique											
		30.5	8.5	6.5	16.4	21	17.5			R 1/8	CPI 081160
		31.5	10.5	9	16.4	21	17.5			R 1/4	CPI 081161
		24	13	11	16.4	21	17.5			R 3/8	CPI 081162
Prise droite prétéflonnée fileté mâle conique											
		30.5	8.5	6.5	16.4	21	17.5			R 1/8	CPI 081160ET
		31.5	10.5	9	16.4	21	17.5			R 1/4	CPI 081161ET
		24	13	11	16.4	21	17.5			R 3/8	CPI 081162ET
Prise droite femelle											
		35	11	16.4	21	17.5				G 1/8	CPI 081100
		37	10	16.4	21	17.5				G 1/4	CPI 081101
Prise 90° fileté mâle conique											
		33	16.4	22	22	24	13	10	8,5	R 1/8	CPI 081160RE
		33	16.4	22	22	24	13	12	10	R 1/4	CPI 081161RE
		33	16.4	22	22	24	13	13	11	R 3/8	CPI 081162RE
Prise 135° fileté mâle conique											
		31	18.5	16.5	10					R 1/8	CPI 081160RO
		30	18.5	16.5	12					R 1/4	CPI 081161RO
			18.5	16.5	12						R 3/8
Prise rallonge fileté mâle cylindrique G 1/8											
		50	16.5	21	17.5	16.4	21			Longueur maxi : 50 mm	CPI 081050F18
		100	60	21	17.5	16.4	21			100 mm	CPI 081100F18
		150	60	21	17.5	16.4	21			150 mm	CPI 081150F18
Prise rallonge fileté mâle cylindrique G 1/4											
		50	26.5	21	17.5	16.4	21			Longueur maxi : 50 mm	CPI 081050F14
		100	60	21	17.5	16.4	21			100 mm	CPI 081100F14
		150	60	21	17.5	16.4	21			150 mm	CPI 081150F14
		200	60	21	17.5	16.4	21			200 mm	CPI 081200F14
Prise rallonge lisse - Filetage à exécuter R 1/4 ou NPT 1/4											
		100	21	17.5	16.4	21				Longueur mini / maxi 34 / 100 mm	CPI 081100L14
		150	21	17.5	16.4	21				100 / 150 mm	CPI 081150L14
		200	21	17.5	16.4	21				150 / 200 mm	CPI 081200L14
Bague de repérage pour prise Ø 8 mm											
										Bague rouge	CPI 08BARG
										Bague bleue	CPI 08BABL

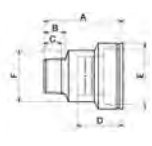

FICHES Ø 8 DE CONNEXION DU FLUIDE

Passage 8 mm	Passage libre	Pression 10 bar	Température -15°C à +90°C						Matière Laiton nickelé	Débit en l/min DP 0,50 bar = 30 l/min
		A	B	C	D	E	F	G	DESIGNATION	REFERENCE
Fiche droite taraudée femelle										
		44	20	16.4					G 1/4	CPI 086101
Fiche droite pour flexible										
		60	23	16.4	20				Ø 8 mm	CPI 086808
		60	23	16.4	20				Ø 10 mm	CPI 086810
		66	28	16.4	20				Ø 12 mm	CPI 086812
Fiche droite pour flexible auto-serreur										
		A utiliser avec tuyau Lockflex								
		61	20	24.5	16.4	19.4			Ø 10 mm	CPI 086810CN
		67	20	29	16.4	23.4			Ø 13 mm	CPI 086813CN
Fiche 90° taraudée femelle										
		58.9	48.5	20	16.4	26.5	16.5		G 1/4	CPI 086101RE
Fiche 90° pour flexible										
		59	16.4	20	48.5	56.5	23.5	23	Ø 8 mm	CPI 086808RE
		56	16.4	20	48.5	43	10	23	Ø 10 mm	CPI 086810RE
		59	16.4	20	48.5	48	10	28	Ø 12 mm	CPI 086812RE
Fiche 135° pour flexible										
		43	16.4	20	44	20.8			Ø 8 mm	CPI 086808RO
		43	16.4	20	44	20.8			Ø 10 mm	CPI 086810RO
		43	16.4	20	49	20.8			Ø 12 mm	CPI 086812RO
Fiche 135° taraudée femelle										
		43	16.4	20	14	20.8			G 1/4	CPI 086101RO
Fiche 90° pour flexible auto-serreur										
		A utiliser avec tuyau Lockflex								
		59	16.4	20	48.5	58	23.5	24.5	Ø 10 mm	CPI 086810CNRE
		59	16.4	20	48.5	64.5	25.5	29	Ø 13 mm	CPI 086813CNRE
Fiche 135° pour flexible auto-serreur										
		A utiliser avec tuyau Lockflex								
		43	16.4	20	45.5	23.5			Ø 10 mm	CPI 086810CNRO
		43	16.4	20	52	28			Ø 13 mm	CPI 086813CNRO
Joint nitrile de rechange pour fiche										
									Pour fiche de Ø 8 mm	CPI 08JNTN

PRISES D'IMPLANTATION Ø 12 SUR MOULES

Passage 12 mm	Passage libre	Pression 10 bar	Température -15°C à +90°C					Matière Laiton nickelé	Débit en l/min DP 0,50 bar = 85 l/min	
		A	B	C	D	E	F	G	DESIGNATION	REFERENCE
Prise droite fileté mâle conique										
		38.5	10.5	8.5	22.4	32	25		R 3/8	CPI 121162
		42	14	12	22.4	32	25		R 1/2	CPI 121163
Prise droite préfileté mâle conique										
		38.5	10.5	8.5	22.4	32	25		R 3/8	CPI 121162ET
		42	14	12	22.4	32	25		R 1/2	CPI 121163ET
Prise rallonge lisse - Filetage à exécuter R 3/8 - NPT 3/8 - R 1/2 ou NPT 1/2										
		150	42	25	22.4	32	17,2	12	56 / 150 mm	CPI 121150L38
		150	42	25	22.4	32	21,3	12	59 / 150 mm	CPI 121150L12
Bague de repérage pour prise Ø 12 mm										
									Bague rouge	CPI 12BARG
									Bague bleue	CPI 12BABL

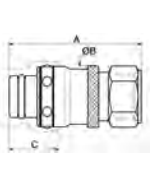
FICHES DE CONNEXION DU FLUIDE Ø 12

Passage 12 mm	Passage libre	Pression 10 bar	Température -15°C à +90°C					Matière Laiton nickelé	Débit en l/min DP 0,50 bar = 85 l/min
		A	B	C	D	E	DESIGNATION	REFERENCE	
Fiche droite taraudée femelle									
		50	28	22.4			G 1/2	CPI 126103	
Fiche droite pour flexible									
		75	28	28	22.4	12.5	Ø 13 mm	CPI 126813	
		75	28	28	22.4	15.5	Ø 16 mm	CPI 126816	

FICHES DE CONNEXION DU FLUIDE Ø 12

Passage 12 mm	Passage libre	Pression 10 bar	Température -15°C à +90°C			Matière Laiton nickelé	Débit en l/min DP 0,50 bar = 85 l/min	
		A	B	C	D	E	DESIGNATION	REFERENCE
Fiche 90° taraudée femelle								
		74.5	28	22.4			G 3/8	CPI 126102RE
Fiche 135° pour flexible								
		71	28	22.4	57	33	Ø 13 mm	CPI 126813RO
		71	28	22.4	57	33	Ø 16 mm	CPI 126816RO
Fiche 90° pour flexible								
		74.5	28	22.4	60	33	Ø 13 mm	CPI 126813RE
		74.5	28	22.4	60	33	Ø 16 mm	CPI 126816RE
Fiche 135° taraudée femelle								
		71	28	22.4	17		G 3/8	CPI 126102RO
Fiche 90° pour flexible auto-serreur								
							A utiliser avec tuyau Lockflex	
		74.5	28	22.4	59.5	28	Ø 13 mm	CPI 126813CNRE
		74.5	28	22.4	66.5	35.5	Ø 16 mm	CPI 126816CNRE
Fiche droite pour flexible auto-serreur								
							A utiliser avec tuyau Lockflex	
		76	28	22.4	13		Ø 13 mm	CPI 126813CN
		83.5	35.5	22.4	16		Ø 16 mm	CPI 126816CN
Fiche 135° pour flexible auto-serreur								
							A utiliser avec tuyau Lockflex	
		71	28	22.4	56.5	28	Ø 13 mm	CPI 126813CNRO
		71	28	22.4	63.5	35	Ø 16 mm	CPI 126816CNRO
Joint nitrile de rechange pour fiche								
							Pour fiche de Ø 12 mm	CPI 12JNTN

RACCORDS RAPIDES POUR FLUIDES

PREOL, CONÇU POUR LA CONNEXION DES FLUIDES (EAU, HUILE...)

CONNEXION FLUIDES

Raccords et embouts conçus pour véhiculer tous les fluides neutres.

Quatre Ø de passage : 6, 9, 12 et 16 mm.



► Applications :

- Circuits de refroidissement
- Circuits d'eau, fluides caloporteurs, huile
- Nettoyage, rinçage
- Industrie agro-alimentaire

FLUIDES VÉHICULÉS

- Eau froide ou chaude jusqu'à 100°C
- Eau glycolée
- Huile chaude jusqu'à 150°C
- Compatible gasoil
- Fluides caloporteurs

OBTURATION

► Simple :

- Raccord auto-obturant muni d'un clapet en laiton utilisé avec un embout à passage libre

► Double :

- Raccord auto-obturant utilisé avec un embout à obturation



► Construction raccord :

- Corps, soupape, obturateur : Laiton
- Bague de manoeuvre :
Ø 6, 9, 12 : Inox, chrome 17%
Ø 16 : Inox, chrome 13% + trempé et chromage
- Ressort : Inox 1809
- Joint plat : PTFE
- Joint torique : Viton

► Construction embout :

- Corps :
Ø 6, 9 et 12 : Laiton
Ø 16 : acier inoxydable trempé
- Soupape et obturateur : Laiton



RACCORDS PREOL

Fluide Eau, huile, fluides caloporteurs	Passage Ø 6, 9, 12 et 16 mm	Température Eau : maxi 100°C Huile : maxi 150°C	Pression P.N. 16 bar	Matière Raccord: corps laiton Bague: inox et chrome Joint : viton
--	--------------------------------	---	-------------------------	---

		A	B	C	D	DESIGNATION		REFERENCE
Raccord taraudé femelle à obturation								
		46	19	17		Passage	Taraudage Gaz BSP	
		53	25	22		Ø 6 mm	G 1/4	PREOL 061101
		67	31	27		Ø 9 mm	G 3/8	PREOL 091102
		91	38	35		Ø 12 mm	G 1/2	PREOL 121103
						Ø 16 mm	G 3/4	PREOL 161104
Raccord fileté mâle cyl. à obturation								
		55	19	17		Passage	Filetage Gaz BSP	
		61	25	22		Ø 6 mm	G 1/4	PREOL 061151
		72	31	27		Ø 9 mm	G 3/8	PREOL 091152
		90	38	35		Ø 12 mm	G 1/2	PREOL 121153
					Ø 16 mm	G 3/4	PREOL 161154	
Raccord pour flexible à obturation								
		60	19			Passage	Flexible	
		69	25			Ø 6 mm	Ø 8 mm	PREOL 061808
		82	31			Ø 9 mm	Ø 12 mm	PREOL 091812
		108	38			Ø 12 mm	Ø 16 mm	PREOL 121816
					Ø 16 mm	Ø 19 mm	PREOL 161819	
Raccord taraudé femelle à obturation 90°								
		57	19		23	Passage	Taraudage Gaz BSP	
		64.5	25		30	Ø 6 mm	G 1/4	PREOL 061101RE
		80	31		37.5	Ø 9 mm	G 3/8	PREOL 091102RE
					Ø 12 mm	G 1/2	PREOL 121103RE	
Raccord fileté mâle cyl. à obturation 90°								
		57	19	17	44	Passage	Filetage Gaz BSP	
		64.5	25	21	52	Ø 6 mm	G 1/4	PREOL 061151RE
		80	31	24	61	Ø 9 mm	G 3/8	PREOL 091152RE
					Ø 12 mm	G 1/2	PREOL 121153RE	
Raccord taraudé femelle à obturation 135°								
		57.7	19		48.5	Passage	Taraudage Gaz BSP	
						Ø 6 mm	G 1/4	PREOL 061101RO
Raccord pour flexible à obturation 90°								
		57	19		48.5	Passage	Flexible	
		64.5	25		57.5	Ø 6 mm	Ø 8 mm	PREOL 061808RE
		65.5	25		65	Ø 9 mm	Ø 10 mm	PREOL 091810RE
					Ø 9 mm	Ø 12 mm	PREOL 091812RE	
Raccord pour flexible à obturation 135°								
		72	19		38.5	Passage	Flexible	
						Ø 6 mm	Ø 8 mm	PREOL 061808RO

EMBOUTS PREOL

Matière Corps Ø 6 - 9 - 12 : Laiton Ø 16 : Inox et Chrome	Passage Ø 6, 9, 12 et 16 mm	Température Eau : maxi 100 °C - Huile : maxi 150 °C	Pression P.N. 16 bar
---	--------------------------------	--	-------------------------

		A	B	C	DESIGNATION		REFERENCE
Embout fileté mâle à clapet							
					Passage	Filetage Gaz BSP	
		46	17		Ø 6 mm	G 1/8	PREOL 067150
		46	17		Ø 6 mm	G 1/4	PREOL 067151
		52	19		Ø 9 mm	G 1/4	PREOL 097151
		48	19		Ø 9 mm	G 3/8	PREOL 097152
		37	22		Ø 9 mm	G 1/2	PREOL 097153
		65	24		Ø 12 mm	G 3/8	PREOL 127152
		62	24		Ø 12 mm	G 1/2	PREOL 127153
		46	27		Ø 12 mm	G 3/4	PREOL 127154
83	32		Ø 16 mm	G 3/4	PREOL 167154		
Embout fileté mâle à passage libre							
					Passage	Filetage Gaz BSP	
		45	17		Ø 6 mm	R 1/8	PREOL 066160
		35	14		Ø 6 mm	R 1/4	PREOL 066161
		51	19		Ø 9 mm	R 1/4	PREOL 096161
		36	17		Ø 9 mm	R 3/8	PREOL 096162
		37	22		Ø 9 mm	G 1/2	PREOL 096153
		63	24		Ø 12 mm	R 3/8	PREOL 126162
		44	22		Ø 12 mm	R 1/2	PREOL 126163
		46	27		Ø 12 mm	G 3/4	PREOL 126154
81	32		Ø 16 mm	R 3/4	PREOL 166164		
Embout taraudé femelle à clapet							
		48	19		Passage	Taraudage Gaz BSP	
					Ø 9 mm	G 1/4 femelle	PREOL 097101
Embout taraudé femelle à passage libre							
					Passage	Taraudage Gaz BSP	
		47	17		Ø 6 mm	G 1/4	PREOL 066101
		48	19		Ø 9 mm	G 1/4	PREOL 096101
		37	22		Ø 9 mm	G 3/8	PREOL 096102
		46.5	27.5		Ø 12 mm	G 1/2	PREOL 126103
58	32		Ø 16 mm	G 3/4	PREOL 166104		
Embout passage libre pour flexibles							
		143	32	29	Passage	Passage	
					Ø 16 mm	Ø 19 mm	PREOL 166819

gamme els

RACCORDS POUR CIRCUITS D'EAU

LE RACCORD AUTOMATIQUE, ET UNIVERSEL POUR CIRCUITS D'EAU

Pour répondre aux différentes configurations des circuits d'eau, le raccord ELS existe à :

► **Obturation :**  au désaccouplement, le raccord coupe automatiquement l'arrivée d'eau.

► **Passage libre :**  au désaccouplement, le raccord laisse ouvert le passage de l'eau. Raccord à débit plus élevé.

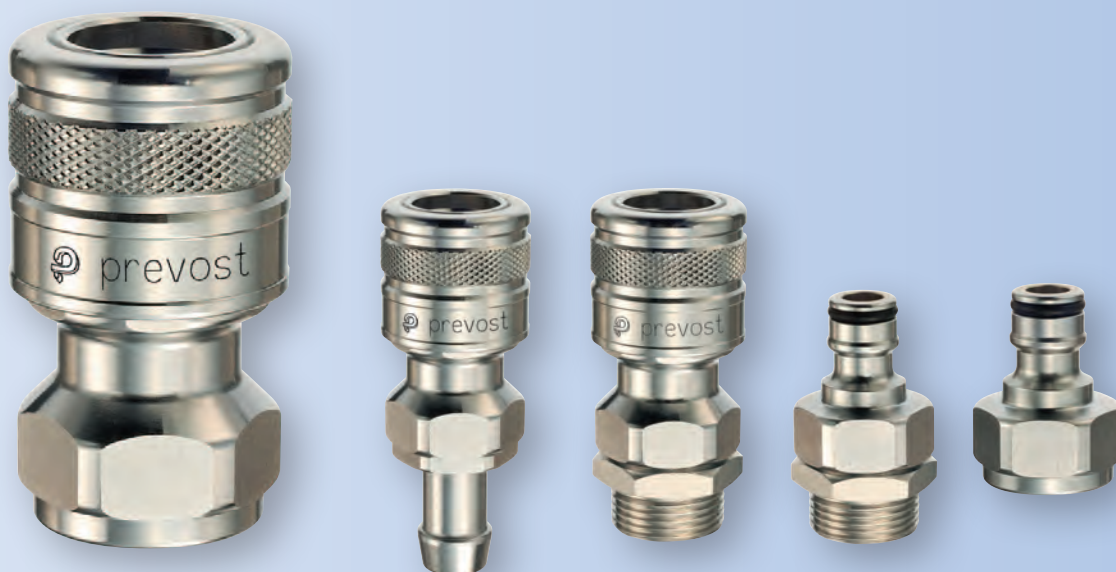

APPLICATIONS	FLUIDES VÉHICULÉS
> Entretien, nettoyage, lessivage	> Eau
> Alimentation machines à nettoyer HP	> Eau de refroidissement à usage industrielle
> Circuits d'eau à usage industriel	> Eau de lavage
> Circuits d'eau de refroidissement	> Eau savonneuse ou associée à des agents de nettoyage (selon PH)
> Bâtiment, travaux publics	> Non utilisable pour l'eau potable
> Agro-alimentaire	> Non alimentaire
> Arrosage	



DÉBIT

Ø de passage à l'intérieur du raccord : 9 mm.

Le débit d'eau dans le raccord est particulièrement élevé : 24 ou 33 l/min.

Le volume d'eau fourni correspond à un large éventail d'utilisations.

CONNEXION STANDARD

Interchangeabilité : la forme du profil d'accouplement raccord/embout est la plus couramment utilisée. Le branchement d'un embout ou d'un raccord ELS avec la plupart des produits existants (plastique ou laiton), du même diamètre de passage, est possible.

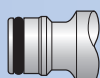

BRANCHEMENT AUTOMATIQUE

- ▶ La connexion du raccord sur l'embout est automatique par simple poussée (sans intervention au niveau de la bague de manoeuvre)
- ▶ La déconnexion se fait par traction arrière de la bague de manoeuvre

ÉTANCHÉITÉ

- ▶ La technologie soupape-joint-ressort du raccord à obturation permet une étanchéité parfaite à l'accouplement comme au désaccouplement
- ▶ La conception rigoureuse, la précision des ajustements mécaniques assurent une fiabilité parfaite du couple raccord-embout Prevost sous pression, même en conditions sévères.
Résistance aux usages intensifs, aux écrasements, aux chocs...
- ▶ **Étanchéité à l'installation**
Le taraudage de chaque raccord et embout est muni d'un joint plat (G 1/2 et G 3/4) enclipsé en fond de filet.

ERGONOMIE

- ▶ **Facilité de manipulation**
La bague de manoeuvre du raccord est moletée ce qui la rend anti-dérapante ; au désaccouplement, le mouvement est facilité.
- ▶ **Sûreté de prise en main**
La forme du raccord, ses dimensions et sa matière ont été étudiées pour qu'il soit facilement tenu en main et pour qu'il s'intègre dans tous les environnements.

CARACTÉRISTIQUES TECHNIQUES

> MATIÈRE

- Corps et bague : laiton chromé
- Aiguille : inox haute résistance
- Soupape : composite
- Ressort : acier inox
- Joints : NBR

> TEMPÉRATURE D'UTILISATION DU RACCORD

- Avec embout laiton : - 15°C à + 60° C
- Avec embout plastique : + 1°C à + 40° C

> PRESSION MAXI DE SERVICE

- Avec embout Prevost ELP 09 : 10 bar
- Avec embout plastique : 5 bar







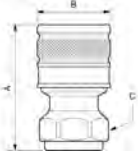

> DÉBITS D'EAU

- ΔP : 0,3 bar
- Raccord avec obturation + embout Prevost : 24 l/min
- Raccord sans obturation + embout Prevost : 33,5 l/min

> COMPATIBILITÉS MATIÈRE

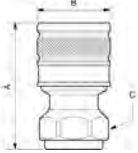
- Bonne résistance :
- aux environnements agro-alimentaires : laiteries, fromageries, brasseries, abattoirs et autres unités de transformation et de conditionnement de viande, poisson...
 - à la corrosion, au contact de différents produits chimiques (informations complémentaires sur demande).



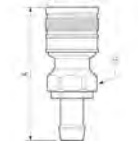

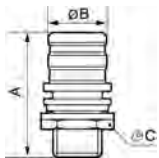

RACCORDS AUTOMATIQUES POUR CIRCUITS D'EAU

Fluide Eau, Eau + détergent Eau + antigel	Passage 9 mm Profil standard	Débit important Raccord à obturat ° 24 l/min, Raccord sans obturat° 33 l/min			Pression 0 - 10 bar	Température -15°C à +60°C	Matière Laiton chromé Soupape:composite	Matière Joints:nitrile Aiguille +ressort:inox
		A	B	C	DESIGNATION			REFERENCE
Raccord taraudé à passage libre								
					Débit : delta P 0,3 bar : 33,5 l/min Passage libre			
		61	35	60	G 1/2 femelle			ELS 090103
		61	35	60	G 3/4 femelle			ELS 090104
		62.5	35	60	G 1 femelle			ELS 090105
Raccord fileté à passage libre								
		76	35	30	G 1/2 mâle			ELS 090153
		76	35	30	G 3/4 mâle			ELS 090154
Raccord pour flexible à passage libre								
		89	35	30	Ø 13 mm			ELS 090813
		89	35	30	Ø 15/16 mm			ELS 090815
		89	35	30	Ø 19 mm			ELS 090819
Raccord taraudé à obturation								
					Débit : delta P 0,3 bar : 24 l/min Raccord à obturation : coupure de l'arrivée d'eau au désaccouplement			
		61	35	60	G 1/2 femelle			ELS 091103
		61	35	60	G 3/4 femelle			ELS 091104
		62.5	35	60	G 1 femelle			ELS 091105
Raccord fileté à obturation								
		76	35	30	G 1/2 mâle			ELS 091153
		76	35	30	G 3/4 mâle			ELS 091154
Raccord pour flexibles à obturation								
		89	35	30	Ø 13 mm			ELS 091813
		89	35	30	Ø 15/16 mm			ELS 091815
		89	35	30	Ø 19 mm			ELS 091819









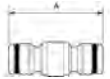

RACCORDS AUTOMATIQUES POUR CIRCUITS D'EAU

Fluide Eau, Eau + détergent Eau + antigel	Passage 9 mm Profil standard	Débit important Raccord à obturat ° 24 l/min, Raccord sans obturat° 33 l/min	Pression 0 - 10 bar	Température -15°C à +60°C	Matière Laiton chromé Soupape:composite	Matière Joints:nitrile Aiguille +ressort:inox
		A	B	C	DESIGNATION	REFERENCE
Raccord traversée de cloison à obturation						
		59	30	32	Raccord semi-automatique pour borne de distribution d'eau. Traversée de cloison. Ø de perçage: 28 mm Epaisseur de la platine: 20 mm Filetage mâle G 3/4	ELS 092154

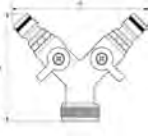
EMBOUTS POUR RACCORDS D'EAU

Fluide Eau, Eau + détergents	Passage 9 mm	Profil standard	Pression 10 bar maxi.	Matière Laiton chromé	Résistance aux usages intensifs	
		A	B	C	DESIGNATION	REFERENCE
Embout taraudé femelle						
		42	30		G 1/2 femelle	ELP 096103
		42	30		G 3/4 femelle	ELP 096104
		60	30		G 1 femelle	ELP 096105
Embout fileté						
		57	30		G 1/2 mâle	ELP 096153
		57	30		G 3/4 mâle	ELP 096154
Embout pour flexibles						
		70	30		Ø 13 mm	ELP 096813
		70	30		Ø 15 mm	ELP 096815
		70		30		Ø 19 mm

EMBOUS POUR RACCORDS D'EAU

Fluide Eau, Eau + détergents		Passage 9 mm		Profil standard		Pression 10 bar maxi.		Matière Laiton chromé		Résistance aux usages intensifs	
		A	B	C	DESIGNATION				REFERENCE		
Embout double de liaison pour raccords											
		50			Liaison de 2 raccords				ELP 096002		
Embout triple de liaison pour raccord											
		61	68		Liaison de 3 raccords				ELP 096003		
Distributeur 2 directions avec vannes de coupure											
		90	103		G 1/2 femelle				ELP 098103		
		90	103		G 3/4 femelle				ELP 098104		
Kit de connexion rapide											
					Comprenant: - 1 raccord à obturation pour tuyau - 2 embouts femelles G 3/4 BSP - 1 mamelon double G 3/4 x G 1/2 BSP - 1 prolongateur G 3/4 mâle x G 1 femelle BSP - 2 colliers pour montage tuyau						
					Alimentation eau, basse pression : pistolet de lavage, machine eau chaude						
					Kit pour tuyau : Ø 13 mm				ELS KITBP13		
					Ø 15 mm				ELS KITBP15		
					Ø 19 mm				ELS KITBP19		
Fourrure à joint plat											
		15			Filetage G 3/4	Taroudage G 1/2	EFO 3412				
Jonction fileté cylindrique pour flexibles											
		41	27		Filetage G 3/4	Pour tuyau Ø int. 13 mm	EFT 3413				
		41	27		G 3/4	Ø int. 15 mm	EFT 3415				
		41	27		G 3/4	Ø int. 19 mm	EFT 3419				

gamme isoflam

RACCORDS DE SÉCURITÉ POUR CHALUMEAUX

RACCORDS SÉCURITÉ ISOFLAM, LA SOUDURE EN TOUTE SÉCURITÉ

Les raccords de sécurité soudure oxyacétylénique sont très performants pour protéger l'utilisateur des dangers liés aux gaz utilisés. Pour les connexions et déconnexions des tuyaux et du chalumeau, les raccords ISOFLAM permettent d'optimiser votre sécurité. Prévost propose également des ensembles tuyaux/raccords montés étanches, prêts à l'emploi.

La gamme ISOFLAM est conforme aux :

- ▶ Dispositifs de sécurité aux normes :
 - Internationales : **ISO 5175**
 - Européennes : **DIN EN 730**

- ▶ Dispositifs de branchement aux normes :
 - Internationales : **ISO 7289**
 - Européennes : **DIN EN 5611**

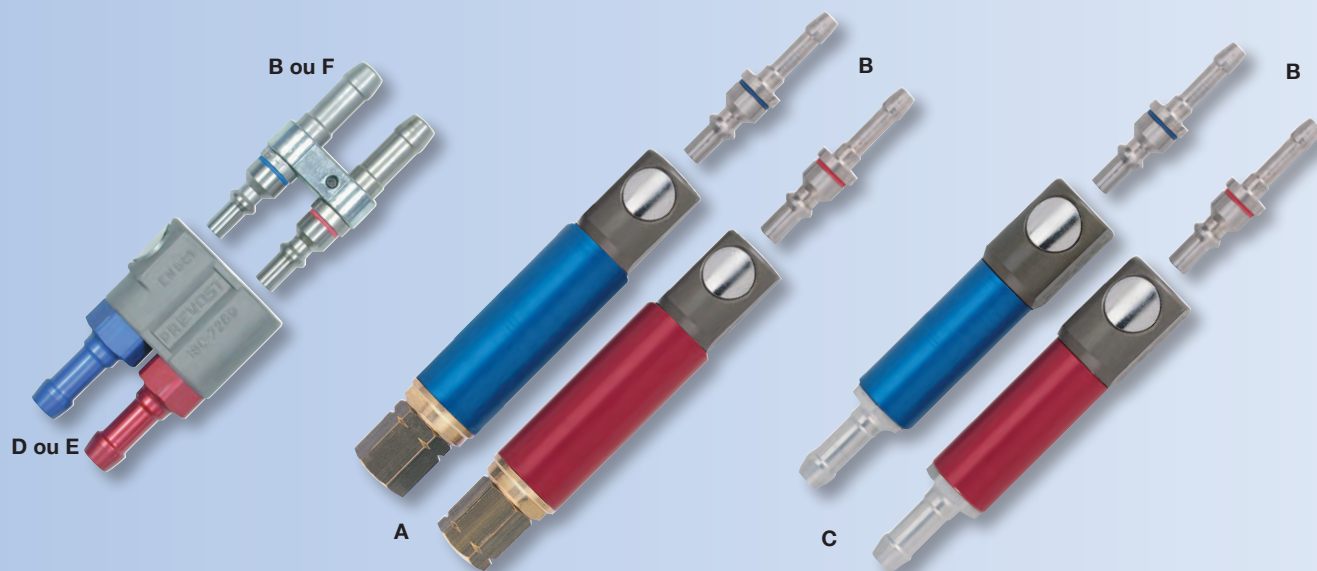

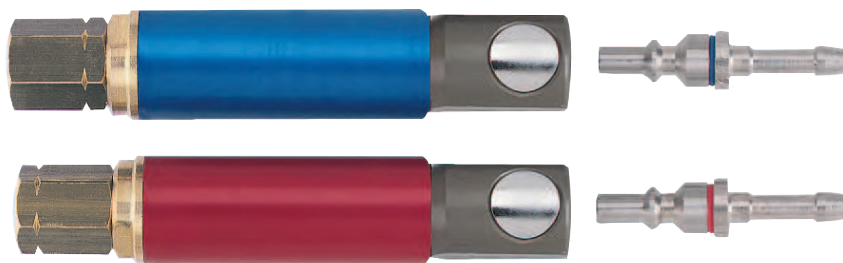

ANTI-RETOUR DE FLAMME

Arrêt de l'ensemble des retours explosifs.
Conforme aux normes internationales.

ANTI-RETOUR DE GAZ

Clapet anti-retour très sensible.
Conforme aux normes internationales.

ARRÊT THERMIQUE

En cas d'incendie, arrêt automatique de l'alimentation des gaz.
Conforme aux normes internationales.

VANNE AUTOMATIQUE

A chaque désaccouplement, l'alimentation se ferme automatiquement.

NON INTER-CHANGEABILITÉ

Non interchangeabilité des embouts suivant les différents gaz employés : acétylène et oxygène.

EMBOUTS COMPATIBLES

Conformes aux normes ISO.

ACIER TRAITÉ

Embouts et raccords en acier traité au chrome, trempé et rectifié.

BOUTON POUSSOIR

- Connexion : simple poussée de l'embout dans le raccord
- Déconnexion : simple pression sur le bouton poussoir.

DOUBLE ÉTANCHÉITÉ

2 joints assurent l'étanchéité sur l'embout.

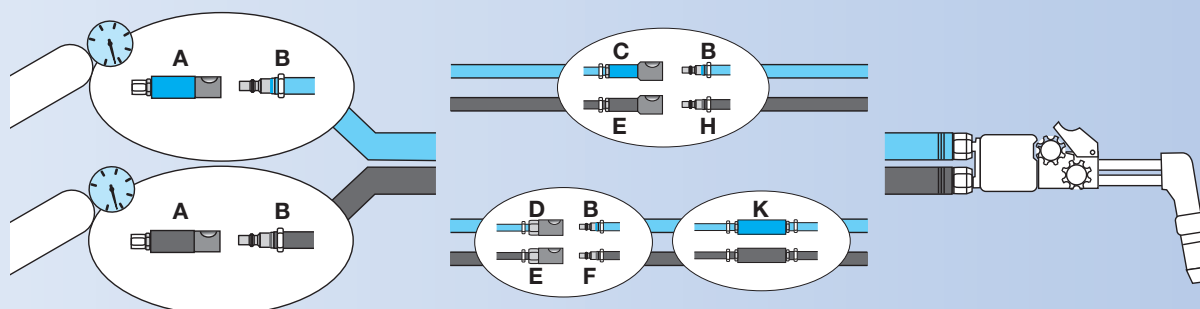

A + B : protection des bouteilles

C + B : raccord mono et protection du soudeur, sécurités intégrées dans le raccord

D + B : rallonge mono pour le changement de chalumeau - passage libre

K : sécurités intégrées sur manchette de tuyau

Pression maxi de service
Raccords et embouts
Acétylène : 1,5 bar
Oxygène : 12,5 bar

SOUDER ET DÉCOUPER EN TOUTE SÉCURITÉ

La gamme des raccords ISOFLAM répond aux normes de sécurité :

> Dispositifs de sécurité pour le soudage :

Normes DIN EN 730 et ISO 5175

Les normes fixent les spécifications pour le gaz combustible et l'oxygène, servant au soudage ou découpage : anti-retour de gaz, anti-retour de flamme, arrêt thermique de débit et autres prescriptions.

> Système de raccordement à obturation pour le soudage :



Normes DIN EN 561 et ISO 7289

Les normes concernent les raccords rapides à obturation utilisés dans les installations de soudage permettant des accouplements et des désaccouplements à la main et sous pression.



- Raccords : oxygène et gaz combustible
- Raccords comprenant le dispositif d'obturation du côté de la source de gaz
- Non interchangeabilité entre les deux gaz
- Accouplement et désaccouplement faciles
- Dureté de protection de surface et matière
- Pression de service maximale 20 bar
- Étanchéité
- Perte de charge < 10 %

ENSEMBLES COMPLETS POUR INSTALLATIONS SOUDURE



Sécurité Anti-retour de flamme - Anti-retour de gaz - Arrêt thermique de débit	Matière Acier traité	Connexion conforme aux normes - ISO 7289 - DIN EN 5611	Sécurité conforme aux normes - ISO 5175 - DIN EN 730	Pression maxi de service Acétylène: 1,5 bar Oxygène: 12,5 bar
---	-------------------------	--	--	---

		DESIGNATION	REFERENCE
Raccord de sécurité à visser sur détendeur			
		Ensemble pour protection des bouteilles Kit comprenant: 2 raccords + 2 embouts, 2 colliers à oreilles Fonction anti retour de flamme et anti retour de gaz Fonction arrêt thermique de débit Fonction raccordement rapide ENTREE Sortie détendeur	
		SORTIE pour tuyau 16 x 150	10 x 17 SIK 10316S3
Raccord complet pour flexible			
		Ensemble pour protection du soudeur Kit comprenant: 2 raccords + 2 embouts, 4 colliers à oreilles Fonction anti-retour de flamme Fonction anti-retour de gaz Fonction raccordement rapide ENTREE Sortie détendeur	
		SORTIE pour tuyau 6 x 12	6 x 12 SIK 0606
		10 x 17	6 x 12 SIK 1006
		10 x 17	10 x 17 SIK 1010

ENSEMBLES COMPLETS POUR INSTALLATIONS SOUDURE

Sécurité Anti-retour de flamme - Anti-retour de gaz - Arrêt thermique de débit	Matière Acier traité	Connexion conforme aux normes - ISO 7289 - DIN EN 5611	Sécurité conforme aux normes - ISO 5175 - DIN EN 730	Pression maxi de service Acétylène: 1,5 bar Oxygène: 12,5 bar
DESIGNATION				
REFERENCE				
Raccord et embout DUO de sécurité				
	Ensemble pour protection du soudeur Kit comprenant: 2 raccords + 2 embouts, 4 colliers à oreilles			
	Fonction anti-retour de flamme Fonction anti-retour de gaz Fonction raccordement rapide			
	ENTREE Sortie détenteur			SORTIE pour tuyau
	6 x 12	6 x 12		SIK 0606DS
10 x 17	6 x 12		SIK 1006DS	
10 x 17	10 x 17		SIK 1010DS	
Raccord et embout DUO à passage libre pour rallonge				
	Ensemble de raccordement à passage libre pour rallonge Kit comprenant: 2 raccords + 2 embouts, 4 colliers à oreilles Fonction raccordement rapide			
	ENTREE Sortie détenteur			SORTIE pour tuyau
	6 x 12	6 x 12		SIK 0606DR
	10 x 17	6 x 12		SIK 1006DR
10 x 17	10 x 17		SIK 1010DR	
Raccord et embout MONO à passage libre pour rallonge				
	Ensemble de raccordement à passage libre pour rallonge Kit comprenant: 2 raccords + 2 embouts, 4 colliers à oreilles Fonction raccordement rapide			
	ENTREE Sortie détenteur			SORTIE pour tuyau
	6 x 12	6 x 12		SIK 0606MR
	10 x 17	6 x 12		SIK 1006MR
10 x 17	10 x 17		SIK 1010MR	

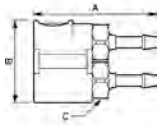

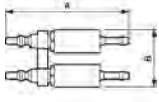

RACCORDS ET EMBOUTS DUO POUR SOUDURE

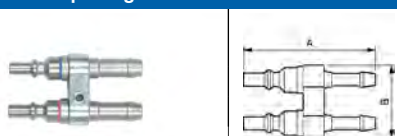
Application Soudage Découpage	Fluide Oxygène Acétylène	Fonction raccordement	Sécurité
DESIGNATION			
REFERENCE			
Raccord rallonge DUO			
		Fonction raccordement rapide Oxygène et acétylène	
		Pour tuyau Ø 6 mm	SIJ 061806K
		Pour tuyau Ø 10 mm	SIJ 061810K
Embout DUO de sécurité anti-retour			
		Fonctions : anti retour de flamme et anti retour de gaz Fonction raccordement rapide Oxygène et acétylène	
		Pour tuyau Ø 6 mm	SIJ 066806S2K
		Pour tuyau Ø 10 mm	SIJ 066810S2K



RACCORDS ET EMBOUTS DUO POUR SOUDURE

Application Soudage Découpage		Fluide Oxygène Acétylène			Fonction raccordement	Sécurité
		A	B	C	DESIGNATION	REFERENCE
Embout duo à passage libre						
					Fonction raccordement rapide Oxygène et acétylène	
		70	38		Pour tuyau Ø 6 mm	SIJ 066806K
		70	38		Pour tuyau Ø 10 mm	SIJ 066810K

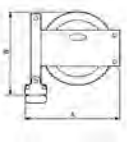

RACCORDS ET EMBOUTS MONO DE SECURITE POUR SOUDURE

Application Soudage Découpage		Fluide Oxygène Acétylène			Sécurité	Fonction raccordement
		A	B	C	DESIGNATION	REFERENCE
Raccord pour protection des bouteilles						
					Fonctions : anti retour de flamme et anti retour de gaz Fonction arrêt thermique de débit Fonction raccordement rapide Oxygène et acétylène	
		131	26		Taraudage 16 x 150	SIC 061316S3
		131	26		Taraudage G 3/8	SIC 061102S3
Embout à passage libre pour tuyau						
					Fonction raccordement rapide Oxygène et acétylène	
		59			Pour tuyau Ø 6 mm	SIC 066806K
		59			Pour tuyau Ø 10 mm	SIC 066810K
Raccord pour protection du soudeur						
					Fonctions : anti retour de flamme et anti retour de gaz Fonction raccordement rapide Oxygène et acétylène	
		116	22		Pour tuyau Ø 6 mm	SIC 061806S2K
		116	22		Pour tuyau Ø 10 mm	SIC 061810S2K
Raccord rallonge						
					Fonction raccordement rapide Oxygène et acétylène	
		70	22	20	Pour tuyau Ø 6 mm	SIC 061806K
		70	22	20	Pour tuyau Ø 10 mm	SIC 061810K
Anti retour pour flexible O/AD						
					Fonctions : anti retour de flamme et anti retour de gaz Oxygène et acétylène	
		103	22		Entrée tuyau Ø 6 mm - Sortie tuyau Ø 6 mm	SIC 069806806K
		103	22		Entrée tuyau Ø 10 mm - Sortie tuyau Ø 6 mm	SIC 069810806K
	103	22		Entrée tuyau Ø 10 mm - Sortie tuyau Ø 10 mm	SIC 069810810K	

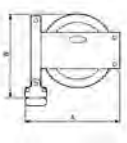
ENROULEURS POUR INSTALLATIONS SOUDURE

Température 60 °C	Matière Peinture époxy	Pression de l'enrouleur 20 bar	Sécurité		Application Soudage, découpage	Fluide Oxygène, acétylène	Arrêt	Facilité d'enroulement et de déroulement Préserve les tuyaux	
			A	B					
SERIE DGO - Tuyaux jumelés sans raccord sécurité ISOFLAM									
		485	480	10 x 17	Oxygène: G 3/8 femelle droit Acétylène: G 3/8 femelle gauche	15	10 x 17	Fixe	DGO 1015OA
SERIE DGO - Tuyaux jumelés avec raccord sécurité ISOFLAM									
		485	480	10 x 17	Oxygène: G 3/8 femelle droit Acétylène: G 3/8 femelle gauche	15	Oxygène : raccord de sécurité isoflam protection du soudeur SIO 061810S2 Acétylène : raccord de sécurité isoflam protection du soudeur SIA 061810S2	Fixe	DGO 1015SIC

RALLONGES DE TUYAUX DE SOUDURE

Equipé monté étanche	Application soudure	Fluide Oxygène Acétylène	Sécurité	
Rallonge soudure complète à visser sur détendeur montée étanche				
	Fonctions : anti retour de flamme et anti retour de gaz Raccordement rapide		REFERENCE	
	Protection du soudeur comprenant: 2 jonctions, 10 m de tuyau soudure jumelée, 2 raccords sécurité, 4 colliers à oreilles conditionnement : emballage carton			
	10 x 150	6 x 12		SIR 06S2
10 x 150	10 x 17	SIR 10S2		
Manchette soudure complète à visser sur chalumeau monté étanche				
	Fonction raccordement rapide comprenant : 2 jonctions, 0,8 m de tuyau soudure jumelée, 2 raccords sécurité, 4 colliers à oreilles		REFERENCE	
	6 x 12	16 x 150		SIM 06
	6 x 12	12 x 100		SIM 0612
	10 x 17	16 x 150		SIM 10

hydraulique

RACCORDS RAPIDES HYDRAULIQUES

LA PUISSANCE HYDRAULIQUE MAÎTRISÉE

APPLICATIONS

- ▶ Connexion et déconnexion de circuits hydrauliques et de circuits de freinage, haute pression et très haute pression

AGRICULTURE

- ▶ Tracteurs, remorques
- ▶ Accessoires et machines agricoles
- ▶ Transport d'insecticides
- ▶ Montage sur remorques et accessoires pour déconnexion automatique
- ▶ Circuits de freinage

INDUSTRIE

- ▶ Vérins, pompes, distributeurs
- ▶ Outils hydrauliques
- ▶ Transport liquides réfrigérants
- ▶ Branchement anti-pollution ambiante et anti-pollution de circuit
- ▶ Protection du fluide hydraulique

TRAVAUX PUBLICS



- ▶ Forage, perforateur, marteaux hydrauliques
- ▶ Chenilles, grues, engins de déneigement
- ▶ Pelleteuses, bulldozers

AUTOMOBILE

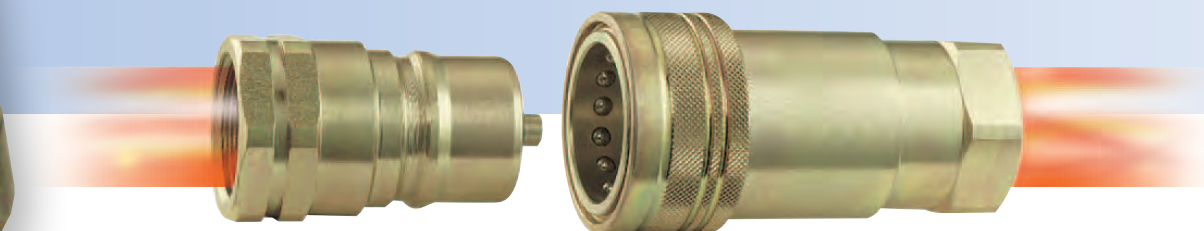

- ▶ Extracteurs
- ▶ Vérins
- ▶ Désincarcérateurs
- ▶ Transport par rail
- ▶ Engins militaires

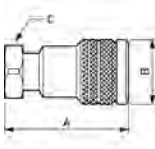

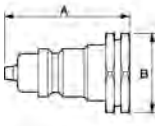

RACCORDS HYDRAULIQUES ISO A OBTURATION A CLAPET

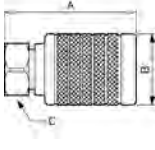
Obturation à clapet	Applications agricoles	Applications industrielles	Matière Acier zingué	Joint nitrile NBR	Température -25° à +125°C	Matière de la bague : anti- extrusion PTFE			
		A	B	C	Taraudage	Diamètre nominal	Pression maxi en bar	Débit hydraulique en l/min	REFERENCE
Raccords hydrauliques ISO A									
		49	26	19	1/4	6	350	4	HCA 061101
		60.5	30	22	3/8	10	300	14	HCA 101102
		70	38	27	1/2	13	250	24	HCA 131103
		84.5	45	34	3/4	20	250	45	HCA 201104
		99	52	41	1	25	200	72	HCA 251105
		70	38	27	22 x 150	13	300	24	HCA 131221
Embouts hydrauliques ISO A									
		35	19		1/4	6	350	4	HCA 066101
		42.5	22		3/8	10	300	14	HCA 106102
		48	27		1/2	13	250	24	HCA 136103
		57	34		3/4	20	250	45	HCA 206104
		65.5	41		1	25	250	72	HCA 256105
		48	27		22 x 150	13	250	24	HCA 136221

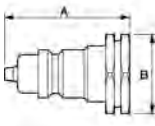

RACCORDS HYDRAULIQUES "PUSH PULL" - ISO A OBTURATION A CLAPET

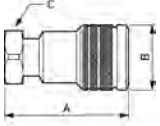
Applications agricoles	Applications industrielles	Joint nitrile NBR	Obturation à clapet	Température -25° à +125°C	Matière Acier zingué	Matière de la bague : anti- extrusion PTFE			
		A	B	C	Taraudage	Diamètre nominal	Pression maxi en bar	Débit hydraulique en l/min	REFERENCE
Raccords hydrauliques "Push Pull" ISO A									
		70	38	27	1/2	13	250	24	HPA 131103
		70	38	27	22 x 150	13	250	24	HPA 131221
Embouts hydrauliques ISO A									
		35	19		1/4	6	350	4	HCA 066101
		42.5	22		3/8	10	300	14	HCA 106102
		48	27		1/2	13	250	24	HCA 136103
		57	34		3/4	20	250	45	HCA 206104
		65.5	41		1	25	250	72	HCA 256105
		48	27		22 x 150	13	250	24	HCA 136221

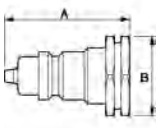
RACCORDS HYDRAULIQUES INTERCHANGEABLES - OBTURATION A CLAPET

Obturation à clapet	Applications agricoles	Applications industrielles	Matière Acier zingué	Joint nitrile NBR	Température -25° à +125°C	Matière de la bague : anti- extrusion PTFE			
		A	B	C	Taraudage Gaz BSP	Diamètre nominal	Pression maxi en bar	Débit hydraulique en l/min	REFERENCE
Raccords hydrauliques interchangeables - obturation à clapet									
		55.5	27	19	1/4	6	350	6,5	HCG 061101
		63	34	24	3/8	10	350	16	HCG 101102
		86	47	34	3/4	20	250	45	HCG 201104
Embouts hydrauliques interchangeables - obturation à clapet									
		38	19		1/4	6	350	6,5	HCG 066101
		42.5	24		3/8	10	300	16	HCG 106102
		57	34		3/4	20	250	45	HCG 206104

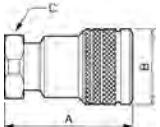
RACCORDS HYDRAULIQUES INTERCHANGEABLES OBTURATION A BILLE

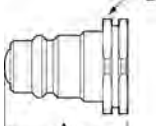
Obturation à bille	Applications agricoles	Applications industrielles	Matière Acier zingué	Joint nitrile NBR	Température -25° à +125°C	Matière de la bague : anti- extrusion PTFE			
		A	B	C	Taraudage Gaz BSP	Diamètre nominal	Pression maxi en bar	Débit hydraulique en l/min	REFERENCE
Raccords hydrauliques interchangeables - obturation à bille									
		55.5	27	19	1/4	6	350	4	HBG 061101
		63	34	24	3/8	10	250	8	HBG 101102
		70	38	27	1/2	13	210	19	HBG 131103
		86	47	34	3/4	20	250	36	HBG 201104
Embouts hydrauliques interchangeables - obturation à bille									
		38	19		1/4	6	250	4	HBG 066101
		42.5	24		3/8	10	250	8	HBG 106102
		48	27		1/2	13	210	19	HBG 136103
		57	34		3/4	20	250	36	HBG 206104



RACCORDS HYDRAULIQUES ANTIPOLLUTION FACES PLANES

Applications agricoles	Applications industrielles	Matière Acier haute résistance	Joint nitrile NBR Bague anti-extrusion PTFE	Température -25°C à +125°C	Sécurité en cas de déconnexion accidentelle	Compatible standard								
							A	B	C	Taraudage Gaz BSP	Diamètre nominal	Pression maxi en bar	Débit hydraulique en l/min	REFERENCE
Raccords hydrauliques - faces planes														
		52.5	27	22	1/4	6	200	8	HFP 061101					
		66	30	27	3/8	13	250	18	HFP 131102					
		71.5	30	27	1/2	13	250	18	HFP 131103					
		78.5	38	32	1/2	20	200	27	HFP 201103					
		84	38	36	3/4	20	200	27	HFP 201104					
		86	48	46	3/4	25	200	60	HFP 251104					
		87.5	48	46	1	25	200	60	HFP 251105					
Embouts hydrauliques - faces planes														
		53.5	22		1/4	6	200	8	HFP 066101					
		63.5	27		3/8	13	250	18	HFP 136102					
		67.5	27		1/2	13	250	18	HFP 136103					
		76	32		1/2	20	200	27	HFP 206103					
		72	36		3/4	20	200	27	HFP 206104					
		82	46		3/4	25	200	60	HFP 256104					
		84.5	46		1	25	200	60	HFP 256105					

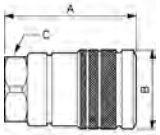

RACCORDS HYDRAULIQUES A VISSER HAUTE PRESSION

Connexion à vissage manuel	Obturation à bille	Matière Acier haute résistance	Joint nitrile NBR Bague anti-extrusion PTFE	Température -25° à +125°C	Compatible standard	Application Auto : vérins, extracteurs de presse								
							A	B	C	Filetage NPT	Diamètre nominal	Pression maxi en bar	Débit hydraulique en l/min	REFERENCE
Raccords hydrauliques à visser - haute pression														
		60	30	21.5	1/4 NPTM	6	700	3,8	HBC 061251					
		71	35	23.5	3/8 NPTM	10	700	6	HBC 101252					
Embouts hydrauliques à visser - haute pression														
		39	19		NPTF 1/4	6	700	3,8	HBC 066201					
		40.5	32		NPTF 3/8	10	700	6	HBC 106202					

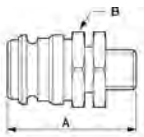

VALVES HYDRAULIQUES DE FREINAGE

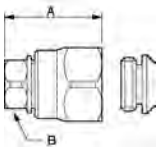
Applications agricoles	Application travaux publics	Connexion automatique	Matière Acier zingué	Joint nitrile NBR Bague anti-extrusion PTFE	Température -25° à +125°C	Branchement circuit de freinage				
		A	B	C	Diamètre nominal	Pression maxi en bar	Débit hydraulique en l/min	Filetage	REFERENCE	
Raccord de valve à freinage										
		55.5	44	27	51	150	15	18 x 150 femelle	HVF 131181	
Embout de valve à freinage										
		52	32		51	150	15	18 x 150 mâle	HVF 136181	

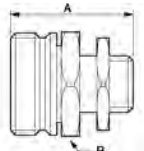

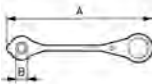

VALVES AGRICOLES A VISSER

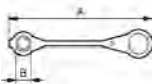
Branchement accessoires machines agricoles	Connexion à vissage manuel	Applications agricoles	Matière Acier zingué	Joint nitrile NBR Bague anti-extrusion PTFE	Température -25° à +125°C				
		A	B	Diamètre nominal	Pression maxi en bar	Débit hydraulique en l/min	Filetage	REFERENCE	
Raccord de valve agricole									
		54	22	51	200	15	18 x 150 femelle	HVV 131181	
Embout de valve agricole									
		49	36	51	200	15		HVV 136181	



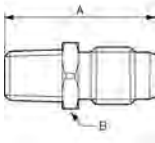

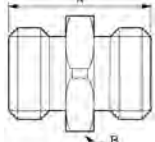
BOUCHONS DE PROTECTION POUR RACCORD HYDRAULIQUE

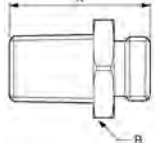
Matière souple PVC		Couleur Rouge		Protection des raccords			
		A	B	Diamètre nominal	Pour raccord Série :	Pour embout Série :	REFERENCE
Bouchons pour raccords							
		157	12	6	HCA		HBP 061A
		161	18	10	HCA		HBP 101A
		295	23	13	HCA		HBP 131A
		105	45	13	HPA		HBP 131PP
		230	17	6	HCG - HBG		HBP 061G
		243	20	10	HCG - HBG		HBP 101G
		236	32	13	HFP		HBP 131FP
		245	38	20	HFP		HBP 201FP
		171	30	13	HVF		HBP 131VF
		173	36	13	HVV		HBP 131VV
		Bouchons pour embouts					
		157	16	6		HCA	HBP 066A
		161	22	10		HCA	HBP 106A
		305	25	13		HCA	HBP 136A
		235	24	13		HPA	HBP 136PP
		250	16	6		HCG - HBG	HBP 066G
		250	21	6		HCG - HBG	HBP 106G
		203	24	13		HFP	HBP 136FP
		240	30	20		HFP	HBP 206FP

CONNECTEURS ACIER HAUTE PRESSION

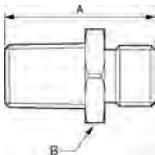
Matière Acier S 300		Matière Acier zingué		Pression Max. Indiquée en bar			
		A	B	DESIGNATION			REFERENCE
Connecteur hydraulique - HNJ							
				Bar	NPTM	JIC 37°	
		30	13	440	NPT 1/8	7/16"	HNJ 250716
		30	14	440	NPT 1/8	1/2"	HNJ 25012
		34	14	420	NPT 1/4	7/16"	HNJ 251716
		34	14	420	NPT 1/4	1/2"	HNJ 25112
		34	17	350	NPT 1/4	9/16"	HNJ 251916
		38	19	350	NPT 1/4	3/4"	HNJ 25134
		35	19	310	NPT 3/8	7/16"	HNJ 252716
		35	19	310	NPT 3/8	1/2"	HNJ 25212
		35	19	310	NPT 3/8	9/16"	HNJ 252916
		38	19	310	NPT 3/8	3/4"	HNJ 25234
		41	24	310	NPT 3/8	7/8"	HNJ 25278
		41	22	290	NPT 1/2	9/16"	HNJ 253916
		44	22	290	NPT 1/2	3/4"	HNJ 25334
		46	24	290	NPT 1/2	7/8"	HNJ 25378
		45	27	250	NPT 3/4	3/4"	HNJ 25434
Connecteur hydraulique - HDD							
				Bar	DIN	DIN	
		26	14	330	14/150	14/150	HDD 141
		26	17	310	16/150	16/150	HDD 161
		27	19	250	18/150	18/150	HDD 181
		32	22	250	22/150	22/150	HDD 221
		33	27	200	26/150	26/150	HDD 261
		34	30	200	30/150	30/150	HDD 301
Connecteur hydraulique - HGD							
				Bar	Gaz conique	DIN	
		30	14	330	R 1/4	14/150	HGD 14141
		30	17	310	R 1/4	16/150	HGD 14161
		30	17	310	R 3/8	16/150	HGD 38161
		31	19	250	R 3/8	18/150	HGD 38181
		37	22	250	R 1/2	18/150	HGD 12181
		39	22	250	R 1/2	22/150	HGD 12221
		40	27	200	R 1/2	26/150	HGD 12261
		40	27	200	R 3/4	26/150	HGD 34261
		41	27	200	R 3/4	30/150	HGD 34301
45	36	200	R 1	30/150	HGD 01301		

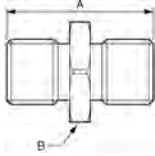
CONNECTEURS ACIER HAUTE PRESSION

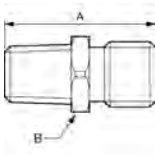
Matière Acier S 300		Matière Acier zingué		Pression Max. Indiquée en bar					
		A	B	DESIGNATION			REFERENCE		
Connecteur hydraulique - HGB									
				Bar	Gaz conique	Gaz BSP cylindrique			
		26	13	440	R 1/8	G 1/8	HGB 1818		
		28	14	440	R 1/8	G 1/4	HGB 1814		
		32	14	420	R 1/4	G 1/8	HGB 1418		
		32	14	420	R 1/4	G 1/4	HGB 1414		
		34	17	350	R 1/4	G 3/8	HGB 1438		
		32	17	310	R 3/8	G 1/4	HGB 3814		
		34	17	310	R 3/8	G 3/8	HGB 3838		
		38	22	310	R 3/8	G 1/2	HGB 3812		
		41	22	290	R 1/2	G 3/8	HGB 1238		
		43	22	290	R 1/2	G 1/2	HGB 1212		
		46	27	250	R 1/2	G 3/4	HGB 1234		
		46	27	250	R 3/4	G 3/4	HGB 3434		
		49	36	200	R 3/4	G 1	HGB 3401		
		53	36	200	R 1	G 1	HGB 0101		
Connecteur hydraulique - HBB									
				Bar	Gaz BSP cyl.	Gaz BSP cylindrique			
		26	13	440	G 1/8	G 1/8	HBB 1818		
		28	14	420	G 1/8	G 1/4	HBB 1814		
		30	14	420	G 1/4	G 1/4	HBB 1414		
		32	17	350	G 1/4	G 3/8	HBB 1438		
		34	17	350	G 3/8	G 3/8	HBB 3838		
		38	22	310	G 3/8	G 1/2	HBB 3812		
		40	22	310	G 1/2	G 1/2	HBB 1212		
		43	27	250	G 1/2	G 3/4	HBB 1234		
		42	24	250	G 5/8	G 5/8	HBB 5858		
		45	27	250	G 3/4	G 3/4	HBB 3434		
		48	36	200	G 3/4	G 1	HBB 3401		
		50	36	200	G 1	G 1	HBB 0101		
		Connecteur hydraulique - HNB							
						Bar	NPTM	Gaz BSP cylindrique	
26	13			440	NPT 1/8	G 1/8	HNB 25018		
28	14			440	NPT 1/8	G 1/4	HNB 25014		
32	14			420	NPT 1/4	G 1/8	HNB 25118		
32	14			420	NPT 1/4	G 1/4	HNB 25114		
34	17			350	NPT 1/4	G 3/8	HNB 25138		
33	19			310	NPT 3/8	G 1/4	HNB 25214		
35	19			310	NPT 3/8	G 3/8	HNB 25238		
38	22			310	NPT 3/8	G 1/2	HNB 25212		
41	22			290	NPT 1/2	G 3/8	HNB 25338		
43	22			290	NPT 1/2	G 1/2	HNB 25312		
46	27			250	NPT 1/2	G 3/4	HNB 25334		
44	27			250	NPT 3/4	G 1/2	HNB 25412		
46	27			200	NPT 3/4	G 3/4	HNB 25434		
49	36			200	NPT 3/4	G 1	HNB 25401		
51	36			200	NPT 1	G 3/4	HNB 25534		
53	36			200	NPT 1	G 1	HNB 25501		
60	46			200	NPT 1 1/4	G 1 1/4	HNB 25642		
64	50			180	NPT 1 1/2	G 1 1/2	HNB 25749		
69	65	150	NPT 2	G 2	HNB 25860				

connecteurs

ACCESSOIRES DE RACCORDEMENT

LE RACCORDEMENT ADAPTÉ POUR RÉSEAU D'AIR COMPRIMÉ

LES CONNECTEURS ASSURENT TOUS LES MONTAGES :

- Jonctions taraudées et filetées pour tuyaux souples
- Jonctions pour raccorder deux tuyaux souples
- Distributeurs deux directions
- Mamelons doubles, mâles ou femelles, cylindriques ou coniques
- Réductions, prolongateurs
- Bouchons, mâles ou femelles
- Traversées de cloison
- Fourrures de réduction ou d'augmentation
- Coiffes pour flexibles
- Equerres, tés, croix
- Pièces de raccordement polyamide
- Pièces de raccordement inox

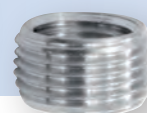
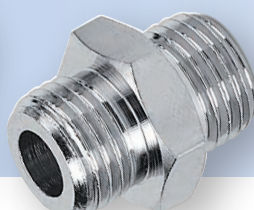
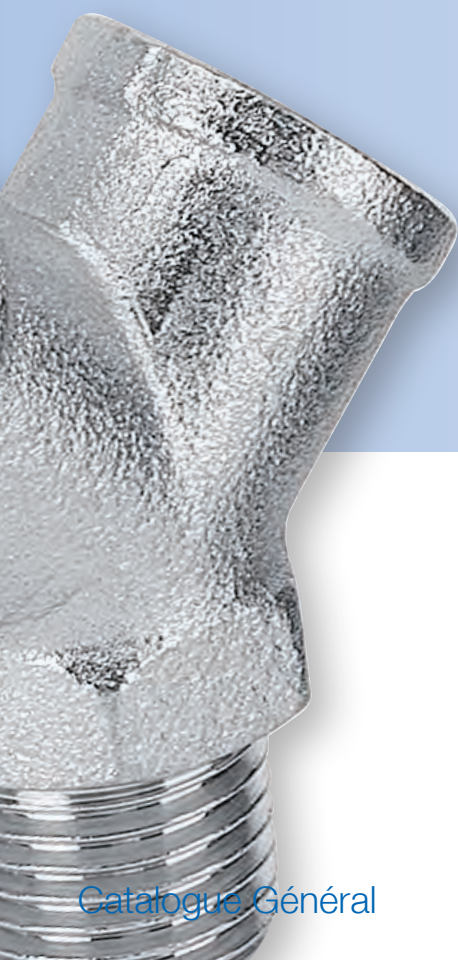

PRODUITS D'ÉTANCHÉITÉ

- Facilité et efficacité de mise en oeuvre
- Raccordements étanches
- Fluides : air, eau, fluides internes



RACCORDS BI-DIRECTIONNELS

- Raccords orientables à 360°
- Libèrent des contraintes liées au tuyau
- Donnent de la souplesse dans la manipulation des outils
- En option : régulateur et manomètre de pression





RACCORDS EXPRESS (p. 168)

- Raccords laiton matricé
- Usages sévères
- Norme NFE 29573
- Fluides : air, eau froide





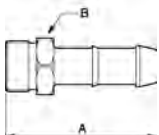

JONCTIONS POUR TUYAUX

Connexion	Gamme étendue Diamètres - filetages	Passage libre Air, Eau, fluides inertes	Pression 0 à 15 bar
-----------	--	--	------------------------

		A	B	DESIGNATION	REFERENCE	
Jonction filetage conique mâle						
				Matière : laiton Filetage Gaz BSP		
				Pour tuyau		
		40	14	R 1/8	Ø int.4 mm	JFT 1804
		40	14	R 1/8	Ø int.6 mm	JFT 1806
		40	14	R 1/8	Ø int.7 mm	JFT 1807
		40	14	R 1/8	Ø int.8 mm	JFT 1808
		44	14	R 1/4	Ø int.4 mm	JFT 1404
		44	14	R 1/4	Ø int.6 mm	JFT 1406
		44	14	R 1/4	Ø int.7 mm	JFT 1407
		44	14	R 1/4	Ø int.8 mm	JFT 1408
		44	14	R 1/4	Ø int.9 mm	JFT 1409
		44	14	R 1/4	Ø int.10 mm	JFT 1410
		44	14	R 1/4	Ø int.12 mm	JFT 1412
		44	19	R 3/8	Ø int.8 mm	JFT 3808
		44	19	R 3/8	Ø int.9 mm	JFT 3809
		44	19	R 3/8	Ø int.10 mm	JFT 3810
		44	19	R 3/8	Ø int.12 mm	JFT 3812
		44	19	R 3/8	Ø int.14 mm	JFT 3814
		44	19	R 3/8	Ø int.16 mm	JFT 3816
		49	24	R 1/2	Ø int.12 mm	JFT 1212
49	24	R 1/2	Ø int.14 mm	JFT 1214		
49	24	R 1/2	Ø int.16 mm	JFT 1216		
49	24	R 1/2	Ø int.19 mm	JFT 1219		
Jonction filetage cylindrique mâle - 1 gorge						
				Matière : Acier traité Filetage Gaz BSP		
				Pour tuyau		
		43	14	G 1/8	Ø int.4 mm	JFT 1804ZS
		43	14	G 1/8	Ø int.6 mm	JFT 1806ZS
		46	17	G 1/4	Ø int.6 mm	JFT 1406ZS
		46	17	G 1/4	Ø int.8 mm	JFT 1408ZS
		46	17	G 1/4	Ø int.9 mm	JFT 1409ZS
		46	17	G 1/4	Ø int.10 mm	JFT 1410ZS
		47	19	G 3/8	Ø int.8 mm	JFT 3808ZS
		47	19	G 3/8	Ø int.10 mm	JFT 3810ZS
		52	19	G 3/8	Ø int.12 mm	JFT 3813ZS
		52	23	G 3/8	Ø int.16 mm	JFT 3816ZS
		53	23	G 1/2	Ø int.8 mm	JFT 1208ZS
		53	23	G 1/2	Ø int.9 mm	JFT 1209ZS
		53	23	G 1/2	Ø int.10 mm	JFT 1210ZS
		53	23	G 1/2	Ø int.13 mm	JFT 1213ZS
		54	23	G 1/2	Ø int.16 mm	JFT 1216ZS
		58	29	G 3/4	Ø int.16 mm	JFT 3416ZS
Jonction filetage cylindrique mâle - 2 gorges						
				Matière : Acier traité Filetage Gaz BSP		
				Pour tuyau		
		74	23	G 1/2	Ø int.19 mm	JFT 1219ZS
		78	29	G 3/4	Ø int.19 mm	JFT 3419ZS
		80	35	G 3/4	Ø int.25 mm	JFT 3425ZS
84	35	G 1	Ø int.19 mm	JFT 0119ZS		
84	35	G 1	Ø int.25 mm	JFT 0125ZS		

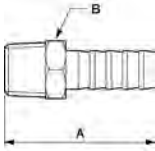
JONCTIONS POUR TUYAUX

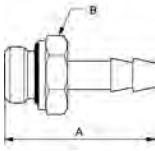
Connexion	Gamme étendue Diamètres - filetages	Passage libre Air, Eau, fluides inertes	Pression 0 à 15 bar
-----------	--	--	------------------------

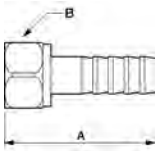



		A	B	DESIGNATION		REFERENCE	
Jonction filetage conique mâle							
				Matière : laiton nickelé Filetage Gaz BSP	Pour tuyau		
		32	12	R 1/8	Ø int.6 mm	JPC 1806	
		32	12	R 1/8	Ø int.7 mm	JPC 1807	
		32	12	R 1/8	Ø int.8 mm	JPC 1808	
		36	14	R 1/4	Ø int.6 mm	JPC 1406	
		36	14	R 1/4	Ø int.7 mm	JPC 1407	
		36	14	R 1/4	Ø int.8 mm	JPC 1408	
		36	14	R 1/4	Ø int.9 mm	JPC 1409	
		36	14	R 1/4	Ø int.10 mm	JPC 1410	
		33	12	R 1/4	Ø int. 13 mm	JPC 1413	
		36	17	R 3/8	Ø int.9 mm	JPC 3809	
		36	17	R 3/8	Ø int.10 mm	JPC 3810	
		36	17	R 3/8	Ø int.13 mm	JPC 3813	
		36	18	R 3/8	Ø int.16 mm	JPC 3816	
		36	21	R 3/8	Ø int.19 mm	JPC 3819	
		39	22	R 1/2	Ø int.10 mm	JPC 1210	
		39	22	R 1/2	Ø int.13 mm	JPC 1213	
		39	22	R 1/2	Ø int.17 mm	JPC 1217	
		39	22	R 1/2	Ø int.19 mm	JPC 1219	
43.5	27	R 3/4	Ø int.15 mm	JPC 3415			
39	27	R 3/4	Ø int.19 mm	JPC 3419			
41	27	R 3/4	Ø int.24 mm	JPC 3424			
53.5	34	R 1	Ø int.24 mm	JPC 0124			
Jonction filetage cylindrique mâle avec joint							
				Matière : laiton nickelé Filetage Gaz BSP	Pour tuyau		
		31	13	G 1/8	Ø int. 6 mm	JMJ 1806	
		34.4	16	G 1/4	Ø int. 6 mm	JMJ 1406	
		34.4	16	G 1/4	Ø int. 7 mm	JMJ 1407	
		34.4	16	G 1/4	Ø int. 8 mm	JMJ 1408	
		35.5	19	G 3/8	Ø int. 8 mm	JMJ 3808	
		39.5	24	G 1/2	Ø int.10 mm	JMJ 1210	
41.5	24	G 1/2	Ø int.16 mm	JMJ 1216			
Jonction taraudage cylindrique femelle							
				Matière : laiton Filetage Gaz BSP	Pour tuyau	Matière	
		30	14	G 1/8	Ø int.6-7 mm	Laiton nickelé	JFTF 1806
		42	17	G 1/4	Ø int.6 mm	Laiton	JFTF 1406
		42	17	G 1/4	Ø int.7 mm	Laiton	JFTF 1407
		42	17	G 1/4	Ø int.8 mm	Laiton	JFTF 1408
		42	17	G 1/4	Ø int.9 mm	Laiton	JFTF 1409
34	20	G 3/8	Ø int.10 mm	Laiton nickelé	JFTF 3810		

JONCTIONS POUR TUYAUX

Connexion		Gamme étendue Diamètres - filetages		Passage libre Air, Eau, fluides inertes		Pression 0 à 15 bar	
		A	B	DESIGNATION		REFERENCE	
Jonction filetage orientable mâle							
				Utilisation unique : air Matière : acier traité Filetage Gaz BSP		Pour tuyau	
		45	15	G 1/4	Ø int.6 mm	JFO 1406	
		45	15	G 1/4	Ø int.7 mm	JFO 1407	
		49	15	G 1/4	Ø int.8 mm	JFO 1408	
		49	15	G 1/4	Ø int.9 mm	JFO 1409	
		52	15	G 1/4	Ø int.10 mm	JFO 1410	
Jonction laiton auto serreur filetage cylindrique mâle							
				Pour montage sans collier du tuyau référence Lockflex Matière : laiton Filetage Gaz BSP		Pour tuyau	Couleur bague
		40.5	19	G 1/4	Ø 10 mm	jaune	AF 15110CN
		47	19	G 1/4	Ø 13 mm	jaune	AF 15113CN
				G 1/4	Ø 13 mm	noir	AF 15113BK
Jonction taraudage femelle avec écrou tournant							
				2 pièces étanchéité sphérique Matière : Laiton nickelé Taraudage Gaz BSP		Pour tuyau	
		39	16	G 1/4	Ø int. 6 mm	JFTT 1406	
		39	16	G 1/4	Ø int. 8 mm	JFTT 1408	
Jonction double							
				Pour tuyau	Matière		
		50	8	Ø int. 4 mm	Laiton		JDT 0404
		50	10	Ø int. 6 mm	Laiton		JDT 0606
		50	12	Ø int. 8 mm	Laiton		JDT 0808
		60	10	Ø int. 9 mm	Laiton		JDT 0909
		50	14	Ø int. 10 mm	Laiton		JDT 1010
		50	16	Ø int. 12 mm	Laiton		JDT 1212
		60	14	Ø int. 13 mm	Laiton		JDT 1313
		58	18	Ø int. 16 mm	Acier traité		JDT 1616
		62	21	Ø int. 19 mm	Acier traité		JDT 1919
72	25	Ø int. 23 mm	Acier traité		JDT 2323		

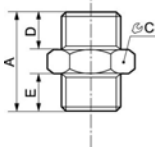

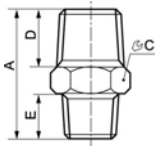
ACCESSOIRES DE RACCORDEMENT

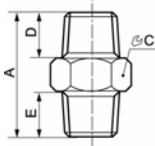
MAMELONS - REDUCTIONS

Connexion		Gamme étendue Diamètres - Filetages				Passage libre Air, eau, fluides inertes		Pression 0 à 15 bar	
		A	C	D	E	DESIGNATION		REFERENCE	
Mamelon double mâle cylindrique - A1									
						Filetage Gaz BSP	Matière		
		11.5	8	4	4	M5 x M5	Laiton nickelé	A1 M5M5	
		14.5	14	6	4	M5 x G 1/8	Laiton nickelé	A1 M518	
		17	14	6	6	G 1/8 x G 1/8	Laiton nickelé	A1 1818	
		19	17	8	6	G 1/8 x G 1/4	Laiton nickelé	A1 1814	
		20	20	9	6	G 1/8 x G 3/8	Laiton nickelé	A1 1838	
		21	17	8	8	G 1/4 x G 1/4	Laiton nickelé	A1 1414	
		22	20	9	8	G 1/4 x G 3/8	Laiton nickelé	A1 1438	
		24	25	10	8	G 1/4 x G 1/2	Laiton nickelé	A1 1412	
		25	14	10	10	G 1/4 x 1/4 NPT	Laiton	A1 14251	
		24	20	9	9	G 3/8 x G 3/8	Laiton nickelé	A1 3838	
		25.5	25	10	9	G 3/8 x G 1/2	Laiton nickelé	A1 3812	
		26.5	25	10	10	G 1/2 x G 1/2	Laiton nickelé	A1 1212	
		27	30	10	11	G 3/4 x G 1/2	Laiton nickelé	A1 3412	
		28.5	30	11	11	G 3/4 x G 3/4	Laiton nickelé	A1 3434	
		30	36	11	12	G 3/4 x G 1	Laiton nickelé	A1 3401	
31	36	12	12	G 1 x G 1	Laiton nickelé	A1 0101			
Mamelon double mâle conique - A2									
						Filetage Gaz BSP	Matière		
		21	12	8	8	R 1/8 x R 1/8	Laiton nickelé	A2 1818	
		24	14	11	8	R 1/8 x R 1/4	Laiton nickelé	A2 1814	
		25	17	11.5	8	R 1/8 x R 3/8	Laiton nickelé	A2 1838	
		27	14	11	11	R 1/4 x R 1/4	Laiton nickelé	A2 1414	
		28	17	11.5	11	R 1/4 x R 3/8	Laiton nickelé	A2 1438	
		32	22	14	11	G 1/4 x G 1/2	Laiton nickelé	A2 1412	
		29	17	11.5	11.5	R 3/8 x R 3/8	Laiton nickelé	A2 3838	
		32.5	22	14	11.5	R 3/8 x R 1/2	Laiton nickelé	A2 3812	
		22	26	10.5	7.5	R 3/8 x R 3/4	Laiton	A2 3834	
		35	22	14	14	R 1/2 x R 1/2	Laiton nickelé	A2 1212	
		37	27	16.5	14	R 1/2 x R 3/4	Laiton nickelé	A2 1234	
		27	33	11	11	R 1/2 x R 1	Laiton	A2 1201	
		39.5	27	16.5	16.5	R 3/4 x R 3/4	Laiton nickelé	A2 3434	
		42.5	34	19	16.5	R 3/4 x R 1	Laiton nickelé	A2 3401	
		31	42	14	11	R 3/4 x R 1 1/4	Laiton	A2 3442	
		37	14	14.5	14.5	R 1/4 x R 1/4 Briggs	Acier traité	A2 3215	
		45.5	34	19	19	R 1 x R 1	Laiton nickelé	A2 0101	
		54.5	54	23	22	R 1 1/2 x R 1 1/4	Laiton nickelé	A2 4942	
		49.5	49	21.5	20	R 1 1/4 x R 1	Laiton nickelé	A2 4201	
		49.5	49	21	21	R 1 1/4 x R 1 1/4	Laiton nickelé	A2 4242	
57	53.5	24	24	R 1 1/2 x R 1 1/2	Laiton nickelé	A2 4949			
59.5	67	26.5	23	R 2 x R 1 1/2	Laiton nickelé	A2 6049			
59	67	25	25	R 2 x R 2	Laiton nickelé	A2 6060			
Mamelon double mâle tournant (3 pièces) - A2T									
						Filetage Gaz BSP	Matière		
		28	15	10	10	G 1/8 x G 1/8	Laiton nickelé	A2T 1818	
		34	19	12	12	G 1/4 x G 1/4	Laiton nickelé	A2T 1414	
		37	27	13	13	G 3/8 x G 3/8	Laiton nickelé	A2T 3838	
		45	27	16	16	G 1/2 x G 1/2	Laiton nickelé	A2T 1212	
		53	36	18	18	G 3/4 x G 3/4	Laiton nickelé	A2T 3434	
65	46	22	22	G 1 x G 1	Laiton nickelé	A2T 0101			

ACCESSOIRES DE RACCORDEMENT

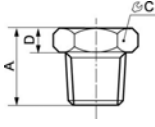
MAMELONS - REDUCTIONS

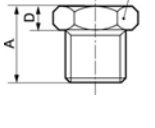







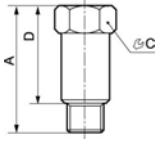

Connexion		Gamme étendue Diamètres - Filetages				Passage libre Air, eau, fluides inertes		Pression 0 à 15 bar	
		A	C	D	E	DESIGNATION		REFERENCE	
Manchon égal - A3									
						Taraudage Gaz BSP	Matière		
		11	8	4		M5 x 0,8	Laiton nickelé	A3 M5	
		15	14	5		G 1/8	Laiton nickelé	A3 18	
		22	17	6		G 1/4	Laiton nickelé	A3 14	
		24	22	7		G 3/8	Laiton nickelé	A3 38	
		30	27	7.5		G 1/2	Laiton nickelé	A3 12	
		32	32	10		G 3/4	Laiton nickelé	A3 34	
		35	38	10		G 1	Laiton nickelé	A3 01	
Réduction mâle conique / femelle - A4									
						Filetage/Taraudage Gaz BSP	Matière		
		16	14	5		R 1/4 x G 1/8	Laiton nickelé	A4 1418	
		17	17	5.5		R 3/8 x G 1/8	Laiton nickelé	A4 3818	
		19.5	22	5.5		R 1/2 x G 1/8	Laiton nickelé	A4 1218	
		17	17	5.5		R 3/8 x G 1/4	Laiton nickelé	A4 3814	
		20	22	6		R 1/2 x G 1/4	Laiton nickelé	A4 1214	
		20	22	6		R 1/2 x G 3/8	Laiton nickelé	A4 1238	
		23	27	6.5		R 3/4 x G 3/8	Laiton nickelé	A4 3438	
		23	27	6.5		R 3/4 x G 1/2	Laiton nickelé	A4 3412	
		25	34	9		R 1 x G 1/2	Laiton nickelé	A4 0112	
		25	34	7		R 1 x G 3/4	Laiton nickelé	A4 0134	
		20	42	6		R 1 1/4 x G 3/4	Laiton	A4 4234	
		19.5	42	5.5		R 1 1/4 x G 1	Laiton	A4 4201	
		33.5	54	10		R 1 1/2 x G 1	Laiton nickelé	A4 4901	
		20	50	6		R 1 1/2 x G 1 1/4	Laiton	A4 4942	
		36	67	10.5		R 2 x G 1 1/4	Laiton	A4 6042	
		36	67	11		R 2 x G 1 1/2	Laiton nickelé	A4 6049	
		21	60	6		R 2 x G 1	Laiton nickelé	A4 6001	
56	80	31		R 2 1/2 x G 1	Fonte malléable	A4 7601			
Réduction mâle cylindrique/femelle - A4Z									
						Filetage/Taraudage Gaz BSP	Matière		
		10.5	14	4.5		G 1/8 x M5	Laiton nickelé	A4 18M5	
		13	17	5		G 1/4 x G 1/8	Laiton nickelé	A4Z 1418	
		14	20	5		G 3/8 x G 1/8	Laiton nickelé	A4Z 3818	
		14	20	5		G 3/8 x G 1/4	Laiton nickelé	A4Z 3814	
		15.5	24	5.5		G 1/2 x G 1/8	Laiton nickelé	A4Z 1218	
		15.5	25	5.5		G 1/2 x G 1/4	Laiton nickelé	A4Z 1214	
		15.5	25	5.5		G 1/2 x G 3/8	Laiton nickelé	A4Z 1238	
		17	30	6		G 3/4 x G 1/4	Laiton nickelé	A4Z 3414	
		17.5	30	6.5		G 3/4 x G 3/8	Laiton nickelé	A4Z 3438	
		17.5	30	6.5		G 3/4 x G 1/2	Laiton nickelé	A4Z 3412	
		36	60	18.5		G 2 x G 1 1/4	Laiton	A4Z 6042	
		36	60	18.5		G 2 x 1 1/2	Laiton	A4Z 6049	
46	67	25		G 2 1/2 x G 2	Laiton	A4Z 7660			

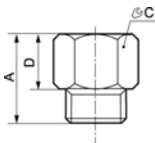
ACCESSOIRES DE RACCORDEMENT PROLONGATEURS

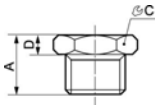
Connexion	Gamme étendue Diamètres - filetages	Passage libre Air, eau, fluides inertes	Pression 0 - 15 bar
-----------	--	--	------------------------

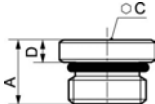

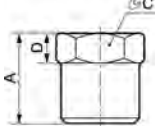

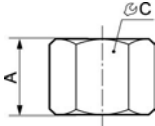

		A	C	D	E	DESIGNATION	REFERENCE	
Prolongateur mâle conique/femelle - A5								
						Filetage/Taraudage Gaz BSP	Matière	
		20	14	12		R 1/8 x G 1/8	Laiton nickelé	A5 1818
		22.5	17	14.5		R 1/8 x G 1/4	Laiton nickelé	A5 1814
		22.5	22	14.5		R 1/8 x G 3/8	Laiton nickelé	A5 1838
		25	17	14		R 1/4 x G 1/4	Laiton nickelé	A5 1414
		28.5	22	17.5		R 1/4 x G 3/8	Laiton nickelé	A5 1438
		29	24	18		R 1/4 x G 1/2	Laiton nickelé	A5 1412
		28.5	22	17		R 3/8 x G 3/8	Laiton nickelé	A5 3838
		32	24	20.5		R 3/8 x G 1/2	Laiton nickelé	A5 3812
		27	32	17		R 3/8 x G 3/4	Laiton nickelé	A5 3834
		34	24	20		R 1/2 x G 1/2	Laiton nickelé	A5 1212
		35	32	21		R 1/2 x G 3/4	Laiton nickelé	A5 1234
		30.5	38	18		R 1/2 x G 1	Laiton nickelé	A5 1201
		30.5	32	17		R 3/4 x G 3/4	Laiton nickelé	A5 3434
		31	38	17.5		R 3/4 x G 1	Laiton nickelé	A5 3401
		27.5	45	17.5		R 3/4 x G 1 1/4	Laiton	A5 3442
28.5	46	16.5		R 1 x G 1 1/4	Laiton	A5 0142		
33	51	19		R 1 1/4 x G 1 1/2	Laiton	A5 4249		
Prolongateur mâle cylindrique/femelle - A5Z								
						Filetage/Taraudage Gaz BSP	Matière	
		17	12	13		M5 x G 1/8	Laiton nickelé	A5 M518
		18.5	14	12.5		G 1/8 x G 1/8	Laiton nickelé	A5Z 1818
		21.5	17	15.5		G 1/8 x G 1/4	Laiton nickelé	A5Z 1814
		22.5	17	14.5		G 1/4 x G 1/4	Laiton nickelé	A5Z 1414
		26	22	18		G 1/4 x G 3/8	Laiton nickelé	A5Z 1438
		24	17	8		G 1/4 x G 1/2	Laiton nickelé	A5Z 1412
		26.5	22	17.5		G 3/8 x G 3/8	Laiton nickelé	A5Z 3838
		29.5	24	20.5		G 3/8 x G 1/2	Laiton nickelé	A5Z 3812
		26	32	9		G 3/8 x G 3/4	Laiton nickelé	A5Z 3834
		29.5	25	19.5		G 1/2 x G 1/2	Laiton nickelé	A5Z 1212
Raccord union 3 pièces mâle cylindrique/femelle tournant - A5T								
						Filetage/Taraudage Gaz BSP	Matière	
		40	25	30	23	G 3/8 x G 3/8	Laiton	A5T 3838
		47	30	33	26	G 1/2 x G 1/2	Laiton	A5T 1212
		53	37	39	31	G 3/4 x G 3/4	Laiton	A5T 3434
		59	46	44	40	G 1 x G 1	Laiton	A5T 0101
		66	54	51	50	G 1 1/4 x G 1 1/4	Laiton	A5T 4242
Raccord mâle cylindrique tournant/femelle (monopiece) - A35								
						Filetage/Taraudage Gaz BSP	Matière	
		40	22	28		G 1/2 x G 1/2	Laiton	A35 1212
		40	30	28		G 1/2 x G 3/4	Laiton	A35 1234

ACCESSOIRES DE RACCORDEMENT PROLONGATEURS BOUCHONS

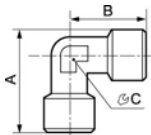
Connexion		Gamme étendue Diamètres - Filetages			Passage libre Air, eau, fluides inertes		Pression 0 - 15 bar	
		A	C	D	DESIGNATION		REFERENCE	
Prolongateur mâle cylindrique/femelle - A5 RL								
					Filetage/Taraudage Gaz BSP	Matière		
		42	14	36	G 1/8 x G 1/8	Laiton nickelé	A5 1818RL	
		51	17	43	G 1/4 x G 1/4	Laiton nickelé	A5 1414RL	
		41	22	32	G 3/8 x G 3/8	Laiton nickelé	A5 3838RL	
		36	27	26	G 1/2 x G 1/2	Laiton nickelé	A5 1212RL	
Prolongateur femelle/femelle - A6								
					Taraudage Gaz BSP	Matière		
		13.5	14	10.5	M5 x G 1/8	Laiton nickelé	A6 M518	
		21.5	17	15.5	G 1/8 x G 1/4	Laiton nickelé	A6 1814	
		23.5	22	15.5	G 1/8 x G 3/8	Laiton nickelé	A6 1838	
		25.5	22	16.5	G 1/4 x G 3/8	Laiton nickelé	A6 1438	
28.5	24	19.5	G 1/4 x G 1/2	Laiton nickelé	A6 1412			
29.5	24	18.5	G 3/8 x G 1/2	Laiton nickelé	A6 3812			
Bouchon mâle cylindrique 6 pans - A7								
					Filetage Gaz BSP	Matière		
		7	14	3	M5 x 0,8	Laiton nickelé	A7 M5	
		10	17	4	G 1/8	Laiton nickelé	A7 18	
		12.5	19	4.5	G 1/4	Laiton nickelé	A7 14	
		13.5	24	4.5	G 3/8	Laiton nickelé	A7 38	
		15.5	30	5.5	G 1/2	Laiton nickelé	A7 12	
16.5	38	5.5	G 3/4	Laiton nickelé	A7 34			
Bouchon mâle cylindrique 6 pans creux avec joint - A7 J								
					Filetage Gaz BSP	Matière		
		6.5	2.5	2.5	M5 - Clé BTR	Laiton nickelé	A7 M5J	
		9.5	3	2.5	G 1/8 - Clé BTR	Laiton nickelé	A7 18J	
		11	6	3	G 1/4 - Clé BTR	Laiton nickelé	A7 14J	
		12.5	8	3.5	G 3/8 - Clé BTR	Laiton nickelé	A7 38J	
14.5	10	3.5	G 1/2 - Clé BTR	Laiton nickelé	A7 12J			
Bouchon mâle conique 6 pans creux - A18								
					Filetage Gaz BSP	Matière		
		12	10	4.5	R 1/8	Laiton nickelé	A18 18	
		15	14	4.5	R 1/4	Laiton nickelé	A18 14	
		16	17	4.5	R 3/8	Laiton nickelé	A18 38	
		17	22	5.5	R 1/2	Laiton nickelé	A18 12	
21	27	5.5	R 3/4	Laiton nickelé	A18 34			
Bouchon femelle - A8								
					Taraudage Gaz BSP	Matière		
		13	14		G 1/8	Laiton nickelé	A8 18	
		15	17		G 1/4	Laiton nickelé	A8 14	
		17.5	20		G 3/8	Laiton nickelé	A8 38	
20	24		G 1/2	Laiton nickelé	A8 12			

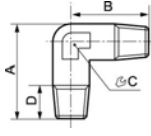
ACCESSOIRES DE RACCORDEMENT

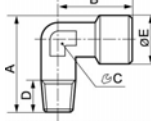
EQUERRES - TES

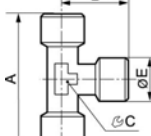





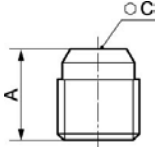

Connexion		Gamme étendue Diamètre - Filetage					Passage libre Air, Eau, Fluides inertes		Pression 0 à 15 bar	
		A	B	C	D	E	DESIGNATION		REFERENCE	
Equerre égale femelle - A9										
		27.5	20.5	10			Taroudage Gaz BSP	Matière		
		34.5	26	13			G 1/8 x G 1/8	Laiton nickelé	A9 1818	
		38.5	30	15			G 1/4 x G 1/4	Laiton nickelé	A9 1414	
		47	36	20			G 3/8 x G 3/8	Laiton nickelé	A9 3838	
		53	36.5	25			G 1/2 x G 1/2	Laiton nickelé	A9 1212	
		64.5	45	30			G 3/4 x G 3/4	Laiton nickelé	A9 3434	
							G 1 x G 1	Laiton nickelé	A9 0101	
Equerre égale mâle conique - A33										
		23.5	18.5	10	8		Filetage Gaz BSP	Matière		
		30	23.5	13	11		R 1/8 x R 1/8	Laiton nickelé	A33 18	
		34.5	26	17	11.5		R 1/4 x R 1/4	Laiton nickelé	A33 14	
		41.5	31	21	14		R 3/8 x R 3/8	Laiton nickelé	A33 38	
		46.5	33	25	16		R 1/2 x R 1/2	Laiton nickelé	A33 12	
		55.5	39	30	17		R 3/4 x R 3/4	Laiton nickelé	A33 34	
							R 1 x R 1	Laiton nickelé	A33 01	
Equerre mâle conique /femelle - A10										
		24.5	20.5	10	8	13.5	Filetage/Taroudage Gaz BSP	Matière		
		32	26	13	12	17	R 1/8 x G 1/8	Laiton nickelé	A10 1818	
		36.5	30	15	12	20.5	R 1/4 x G 1/4	Laiton nickelé	A10 1414	
		44	36	20	16	25.5	R 3/8 x G 3/8	Laiton nickelé	A10 3838	
		49	36.5	25	16	32	R 1/2 x G 1/2	Laiton nickelé	A10 1212	
		58.5	45	30	16	39	R 3/4 x G 3/4	Laiton nickelé	A10 3434	
							R 1 x G 1	Laiton nickelé	A10 0101	
Té égal femelle - A11										
		42	21	10		13.5	Taroudage Gaz BSP	Matière		
		51	26	13		17	G 1/8	Laiton nickelé	A11 18	
		56	28.5	15		20.5	G 1/4	Laiton nickelé	A11 14	
		67	34.5	20		25.5	G 3/8	Laiton nickelé	A11 38	
		73	37	25		32	G 1/2	Laiton nickelé	A11 12	
		90	45	30		39	G 3/4	Laiton nickelé	A11 34	
		90	45	44.5		51.5	G 1	Laiton nickelé	A11 01	
		93	54	50		57.7	G 1 1/4	Laiton nickelé	A11 42	
		103	55	62.5		70	G 1 1/2	Laiton nickelé	A11 49	
							G 2	Laiton nickelé	A11 60	

ACCESSOIRES DE RACCORDEMENT TES

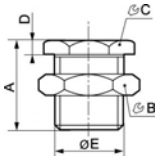

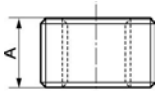
Connexion		Gamme étendue Diamètres - Filetages					Passage libre Air, Eau, fluides inertes		Pression 0 - 15 bar	
		A	B	C	D	E	DESIGNATION		REFERENCE	
							Filetage Gaz BSP	Matière		
		37	18.5	10	8	10	R 1/8	Laiton nickelé	A30 18	
		47	23.5	13	11	12	R 1/4	Laiton nickelé	A30 14	
		52	26	17	11.5	15	R 3/8	Laiton nickelé	A30 38	
		62	31	21	14	20	R 1/2	Laiton nickelé	A30 12	
		66.4	33.2	25	16.2	24	R 3/4	Laiton nickelé	A30 34	
							Taroudage Gaz BSP/ Filetage	Matière		
		39	16.5	10	10	13.5	G 1/8 x R 1/8	Laiton nickelé	A12 1818	
		51	24.5	13	10	17	G 1/4 x R 1/4	Laiton nickelé	A12 1414	
		56	26	15	12	20.5	G 3/8 x R 3/8	Laiton nickelé	A12 3838	
		67	30	20	13	25.5	G 1/2 x R 1/2	Laiton nickelé	A12 1212	
		73	33	25	15	32	G 3/4 x R 3/4	Laiton nickelé	A12 3434	
90	39	30	15	39	G 1 x R 1	Laiton nickelé	A12 0101			
							Filetage/Taroudage Gaz BSP	Matière		
		37	21	10	7		R 1/8 x G 1/8	Laiton nickelé	A31 1818	
		47	25.5	13	12		R 1/4 x G 1/4	Laiton nickelé	A31 1414	
		52	28	15	12		R 3/8 x G 3/8	Laiton nickelé	A31 3838	
		62	33.5	20	15		R 1/2 x G 1/2	Laiton nickelé	A31 1212	
		66.4	36.5	25	15		R 3/4 x G 3/4	Laiton nickelé	A31 3434	
							Taroudage Gaz BSP/ Filetage	Matière		
		37	21	10	16.5	13.5	G 1/8 x R 1/8	Laiton nickelé	A13 1818	
		50.5	26	13	24.5	17	G 1/4 x R 1/4	Laiton nickelé	A13 1414	
		56	28.5	15	26	20.5	G 3/8 x R 3/8	Laiton nickelé	A13 3838	
		66	34.5	20	30	25.5	G 1/2 x R 1/2	Laiton nickelé	A13 1212	
		69.5	37	25	33	32	G 3/4 x R 3/4	Laiton nickelé	A13 3434	
84	45	30	39	39	G 1 x R 1	Laiton nickelé	A13 0101			
							Filetage/Taroudage Gaz BSP	Matière		
		39.5	18.5	10	21	13	R 1/8 x G 1/8	Laiton nickelé	A32 1818	
		49	23.5	13	25.5	17	R 1/4 x G 1/4	Laiton nickelé	A32 1414	
		54	26	17	28	21	R 3/8 x G 3/8	Laiton nickelé	A32 3838	
		64.5	31	21	33.5	26.5	R 1/2 x G 1/2	Laiton nickelé	A32 1212	
		69.5	33	25	36.5	32	R 3/4 x G 3/4	Laiton nickelé	A32 3434	

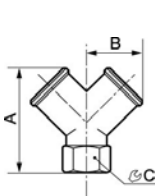
ACCESSOIRES DE RACCORDEMENT

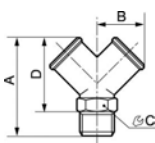
BOUCHONS - FOURRURES ET Y

Connexion		Gamme étendue Diamètres - Filetages					Passage libre Air, Eau, Fluides inertes		Pression 0 à 15 bar	
		A	B	C	D	E	DESIGNATION		REFERENCE	
Bouchon mâle cylindrique 6 pans creux - A20										
		8		6			Filetage Gaz BSP	Matière		
							G 1/8 - Clé BTR de 5	Laiton nickelé	A20 18	
							G 1/4 - Clé BTR de 6	Laiton nickelé	A20 14	
							G 3/8 - Clé BTR de 8	Laiton nickelé	A20 38	
		12		10			G 1/2 - Clé BTR de 10	Laiton nickelé	A20 12	
Traversée de cloison femelle - A21										
		18	19	22	4	15.5	Taraudage	Matière		
							G 1/8	Laiton nickelé	A21 18	
							épaisseur de cloison de 10 mm Ø de perçage 16 mm			
							G 1/4	Laiton nickelé	A21 14	
		26	27	24	5	19.5	épaisseur de cloison de 12 mm Ø de perçage 20 mm			
		26	30	32	5	25.5	G 3/8	Laiton nickelé	A21 38	
		33.5	36	32	6.5	27.5	épaisseur de cloison de 12 mm Ø de perçage 26 mm			
							G 1/2	Laiton nickelé	A21 12	
							épaisseur de cloison de 12 mm Ø de perçage 28 mm			
Fourrure mâle / femelle - FOU										
							Filetage/Taraudage	Matière		
							G 1/4 x G 1/8	Laiton	FOU 1014	
							G 3/8 x G 1/4	Laiton	FOU 1417	
							G 1/2 x G 1/4	Laiton	FOU 1421	
							G 1/2 x G 3/8	Laiton	FOU 1721	
							G 3/4 x G 1/2	Laiton	FOU 2127	
		20					G 1 x G 3/4	Laiton	FOU 2734	
Y femelle - Y										
		26.5	14.5	13			Taraudage Gaz BSP	Matière		
							G 1/8	Laiton nickelé	Y18	
							G 1/4	Laiton nickelé	Y14	
							G 3/8	Laiton nickelé	Y38	
							G 1/2	Laiton nickelé	Y12	
		68.5	36	38.5			G 3/4	Fonte malléable	Y34	
Y mâle cylindrique au centre - YM										
		32	14.5	13	24		Filetage Gaz BSP	Matière		
							G 1/8	Laiton nickelé	Y18M	
							G 1/4	Laiton nickelé	Y14M	
							G 3/8	Laiton nickelé	Y38M	
		53	26.5	25	39		G 1/2	Laiton nickelé	Y12M	

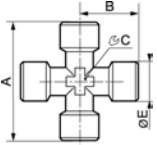

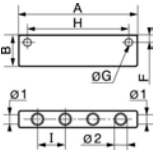
ACCESSOIRES DE RACCORDEMENT CROIX - COIFFES - BLOCS DE DISTRIBUTION

Connexion		Gamme étendue Diamètre - filetage Gamme étendue					Passage libre Air, eau, fluides inertes		Pression 0 - 15 bar	
		A	B	C	D	E	DESIGNATION		REFERENCE	
Croix égale femelle - A14										
		42	21	10		13	Taraudage Gaz BSP	Matière		
		51	25.5	13		17	G 1/8	Laiton nickelé	A14 18	
		56	28	17		21	G 1/4	Laiton nickelé	A14 14	
		67	33.5	21		26.5	G 3/8	Laiton nickelé	A14 38	
								G 1/2	Laiton nickelé	A14 12
Croix égale femelle/mâle conique au centre - A34										
		39.5	21	10	31.5		Filetage/Taraudage Gaz BSP	Matière		
		49	25.5	13	38	R 1/8 x G 1/8	Laiton nickelé	A34 1818		
		54	28	17	42.5	R 1/4 x G 1/4	Laiton nickelé	A34 1414		
		64.5	33.5	21	50.5	R 3/8 x G 3/8	Laiton nickelé	A34 3838		
							R 1/2 x G 1/2	Laiton nickelé	A34 1212	
Coiffe pour flexible mâle cylindrique G 1/4 Gaz BSP - CO										
							Pression maxi : 10 bar Les coiffes sont composées de 2 pièces Pour tuyau Ø int./ext. Matière			
		35	19	17	26	Ø 6 x 11-12	Duralumin	CO 0612		
		38	22	22	28	Ø 8 x 13-14	Duralumin	CO 0814		
		38	24	22	30	Ø 9 x 14-15	Duralumin	CO 0915		
		38	24	22	30	Ø 10 x 15-16	Duralumin	CO 1016		
Bloc de distribution - A15										
		25	16		4.5	G 1/8	Aluminium	A15 18		
		40	20		5.5	G 1/4	Aluminium	A15 14		
		50	25		5.5	G 3/8	Aluminium	A15 38		
		50	25		5.5	G 1/2	Aluminium	A15 12		
Bloc de distribution - A16										
							Entrée Gaz BSP	Sortie Gaz BSP	Matière	
		72	30				2xG 3/8	2xG 1/4	Aluminium	A16 3814S2
		108	30				2xG 3/8	3xG 1/4	Aluminium	A16 3814S3
		144	30				2xG 3/8	4xG 1/4	Aluminium	A16 3814S4
		180	30				2xG 3/8	5xG 1/4	Aluminium	A16 3814S5
		216	30				2xG 3/8	6xG 1/4	Aluminium	A16 3814S6

MALLETTE D'ACCESSOIRES DE RACCORDEMENT

Connexion	Gamme étendue Diamètre - filetage Gamme étendue			Passage libre Air, eau, fluides inertes	Pression 0 - 15 bar
	A	B	C	DESIGNATION	REFERENCE
Mallette de pièces additives					
	385	280	55	Assortiment de 105 pièces de raccordement : 15 jonctions mâles pour tuyau 15 jonctions doubles 30 mamelons doubles mâles 25 réductions mâles/femelles 20 manchons égaux	MAL PA105

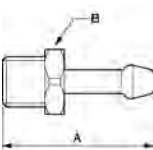
PIECES DE RACCORDEMENT INOX

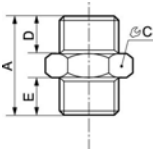
Matière Acier Inox	Connexion	Fluide Air, eau, fluides inertes				Compatibilité ambiances corrosives	Pression P.N. 25 bar
		A	B	C	D	DESIGNATION	REFERENCE
Jonction filetage mâle cylindrique pour tuyau							
						Matière : Inox 316 L Filetage Gaz BSP Ø int. tuyau	
		39	17			G 1/4 Ø int.6 mm	JFT 1406I
		39	17			G 1/4 Ø int.8 mm	JFT 1408I
		41	17			G 1/4 Ø int.10 mm	JFT 1410I
		41	17			G 1/4 Ø int.12 mm	JFT 1412I
Mamelon double mâle conique							
						Matière : Inox 316 L Filetage Gaz BSP	
		30.5	13			R 1/8 x R 1/8	A1 1818I
		25	14			R 1/4 x R 1/4	A1 1414I
		34.5	19			R 3/8 x R 3/8	A1 3838I
		41	23			R 1/2 x R 1/2	A1 1212I
		24.5	24			R 3/4 x R 3/4	A1 3434I

PIECES DE RACCORDEMENT INOX

Matière Acier Inox	Connexion	Fluide Air, eau, fluides inertes				Compatibilité ambiances corrosives	Pression P.N. 25 bar
Réduction double mâle conique inégale		A	B	C	D	DESIGNATION	REFERENCE
						Matière : Inox 316 L Filetage Gaz BSP	
		25	14			R 1/8 x R 1/4	A1 1814I
		35	20			R 1/4 x R 3/8	A1 1438I
		40	24			R 3/8 x R 1/2	A1 3812I
		41	30			R 1/2 x R 3/4	A1 1234I
Raccord mâle cylindrique tournant/femelle (monopiece)						Matière : Inox Filetage/Tarudage Gaz BSP	
		40		22	28	G 1/2 x G 1/2	A35 1212I
		40		30	28	G 1/2 x G 3/4	A35 1234I

JONCTIONS POUR TUYAUX SOUPLES

Matière Plastique injecté	Etanche sur tuyaux souples	Passage libre Air, eau, fluides inertes	Facilité d'emploi		Pression 0 à 10 bar	Température -10°C à +80°C	
Jonction fileté conique		A	B	C	DESIGNATION	REFERENCE	
					Matière : Polyamide Filetage Gaz BSP		
		27	10		R 1/8	Pour tuyau Ø int. 4 mm	JPL 1804
		32	14		R 1/4	Ø int. 4 mm	JPL 1404
		33	10		R 1/8	Ø int. 6 mm	JPL 1806
		37	14		R 1/4	Ø int. 6 mm	JPL 1406
		38	17		R 3/8	Ø int. 6 mm	JPL 3806
		41	14		R 1/4	Ø int. 8 mm	JPL 1408
		41	17		R 3/8	Ø int. 8 mm	JPL 3808
		49	22		R 1/2	Ø int. 8 mm	JPL 1208
		44	14		R 1/4	Ø int. 10 mm	JPL 1410
		44	17		R 3/8	Ø int. 10 mm	JPL 3810
		46	17		R 3/8	Ø int. 12 mm	JPL 3812
		54	22		R 1/2	Ø int. 12 mm	JPL 1212

JONCTIONS POUR TUYAUX SOUPLES



Matière Plastique injecté	Etanche sur tuyaux souples	Passage libre Air, eau, fluides inertes			Facilité d'emploi	Pression 0 à 10 bar	Température -10°C à +80°C
		A	B	C	DESIGNATION	REFERENCE	
Coude mâle 90° conique							
					Matière : Polyamide Filetage Gaz BSP	Pour tuyau	
		27	19	10	R 1/8	Ø int. 4 mm	JPL 51804
		46	37	14	R 1/4	Ø int. 4 mm	JPL 51404
		34	25	10	R 1/8	Ø int. 6 mm	JPL 51806
		37	30	14	R 1/4	Ø int. 6 mm	JPL 51406
		38	31	17	R 3/8	Ø int. 6 mm	JPL 53806
		41	38	14	R 1/8	Ø int. 8 mm	JPL 51808
		41	32	14	R 1/4	Ø int. 8 mm	JPL 51408
		46	37	17	R 3/8	Ø int. 8 mm	JPL 53808
		46	37	14	R 1/4	Ø int.10 mm	JPL 51410
		48	36	17	R 3/8	Ø int.10 mm	JPL 53810
Té mâle au centre conique							
					Matière : Polyamide Filetage Gaz BSP	Pour tuyau	
		43	21	10	R 1/8	Ø int. 4 mm	JPL 71804
		43	26	14	R 1/4	Ø int. 4 mm	JPL 71404
		57	25	10	R 1/8	Ø int. 6 mm	JPL 71806
		57	30	14	R 1/4	Ø int. 6 mm	JPL 71406
		67	32	14	R 1/4	Ø int. 8 mm	JPL 71408
71	37	17	R 3/8	Ø int. 10 mm	JPL 73810		
Jonction double pour tuyau							
					Matière : Résine acétal Pour tuyau		
		35			Ø 4 mm	JPL 34	
		49			Ø 6 mm	JPL 36	
		56			Ø 8 mm	JPL 38	
62			Ø 10 mm	JPL 310			
Coude égal à 90°							
					Matière : Résine acétal Pour tuyau		
		22			Ø 4 mm	JPL 64	
		31			Ø 6 mm	JPL 66	
		37			Ø 8 mm	JPL 68	
39			Ø 10 mm	JPL 610			
Té égal pour tuyau							
					Matière : Résine acétal Pour tuyau		
		35	22		Ø 4 mm	JPL 94	
		50	29		Ø 6 mm	JPL 96	
		58	35		Ø 8 mm	JPL 98	
63	39		Ø 10 mm	JPL 910			
Y							
					Matière : Résine acétal Pour tube		
		27	24		Ø 4 mm	JPL Y4	
		46	40		Ø 6 mm	JPLY 6	
		53	48		Ø 8 mm	JPLY 8	
57	51		Ø 10 mm	JPLY 10			
Croix égale							
					Matière : Résine acétal Pour tube		
		39			Ø 4 mm	JPL X4	
47			Ø 6 mm	JPL X6			

PRODUITS D'ETANCHEITE

Application raccordement	Fluide Air, eau, fluides inertes	Facilité d'emploi	Etanchéité des montages	Efficacité	Etanchéité immédiate
		DESIGNATION			REFERENCE
Produit d'étanchéité anaérobie					
		Contenance : 50 g Etanchéité : en 2 heures des filets du G 1/8 au G 1 Gaz Temps de prise : immédiate à 25°C Tenue à la pression : 6 bar Matières à assembler : acier et laiton nickelé Couleur : violet Résistance au cisaillement : 17-23N/mm ² après 24 heures Non toxique			
		Tube de 50 gr.			ETANCHE 177
Rouleau de bande PTFE					
		Bande de 100% PTFE Rouleau de 12 mètres Largeur : 12 mm Epaisseur : 0,076 mm Couleur : blanc			
		Ruban d'étanchéité 100 % PTFE Longueur : 12 mètres			TEFLON 12
Fibre d'étanchéité					
		Fibre multifilamentaire imprégnée Bobine de 150 mètres en boîte dévidoir Pression maxi de service: -Air comprimé : 7,5 bar -Eau : 16 bar -Gaz : 5 bar Adaptée aux filetages métalliques et plastiques Compatible avec air, eau, gaz.			
		Bobine dévidoir de 150 m de fibre d'étanchéité			FLT 150

RACCORDS BIDIRECTIONNELS

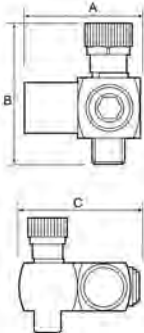
Orientable 360°	Efficacité	Matière Zamac	Débit 45 m ³ /h sous 7 bar	Facilité d'emploi
--------------------	------------	------------------	--	-------------------

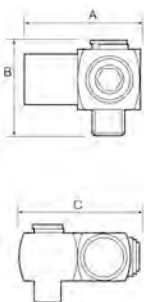
		A	B	C	DESIGNATION	REFERENCE
Raccord bidirectionnel avec régulateur pour outils pneumatiques						
					<ul style="list-style-type: none"> - Permet de garder le tuyau droit et sans contrainte. - Améliore la manipulation et l'utilisation des outils pneumatiques. - Entrée : G 1/4 Gaz BSP femelle - Sortie : G 1/4 Gaz BSP mâle 	
		36	64	43.5	Raccord bidirectionnel 360° avec régulateur et mano 0 à 10 bar	OP BDMR
					Raccord bidirectionnel 360° avec régulateur	OP BDR
Raccord bidirectionnel pour outils pneumatiques						
					<ul style="list-style-type: none"> - Permet de garder le tuyau droit et sans contrainte. - Améliore la manipulation et l'utilisation des outils pneumatiques. - Entrée : G 1/4 Gaz BSP femelle - Sortie : G 1/4 Gaz BSP mâle 	
		35	42.5	43	Raccord bidirectionnel 360° avec mano 0 à 10 bar	OP BDM
					Raccord bidirectionnel 360°	OP BD

ROTULES

Efficacité	Orientable 360°	Matière Corps inox Protecteur caoutchouc	Facilité d'emploi	Anti rayures	Passage 8 mm
------------	--------------------	---	-------------------	--------------	-----------------

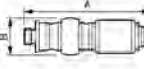
		A	B	DESIGNATION		REFERENCE
Rotule pour liaison air comprimé						
				Entrée	Sortie fileté mâle	
		127	40	G 1/4	G 1/4	PFA 085101
		127	40	G 3/8	G 1/4	PFA 085102
		127	40	pour tuyaux Ø 6 mm	G 1/4	PFA 085106
		127	40	pour tuyaux Ø 8 mm	G 1/4	PFA 085108
		127	40	pour tuyaux Ø 10 mm	G 1/4	PFA 085110

VANNES À BOISSEAU SPHÉRIQUE

INDISPENSABLE POUR ISOLER LES ÉLÉMENTS D'UN RÉSEAU

- ▶ Vanne laiton, passage intégral, mâle-mâle ou femelle-femelle
- ▶ Vanne à poignée papillon, mâle-mâle, faible encombrement, débit important
- ▶ Vanne à décompression, laiton, échappement par purge de l'air en aval
- ▶ Vanne inox, pour environnements agressifs et fluides corrosifs
- ▶ Vanne à décompression cadenassable, laiton ou inox
Vérouillage par cadenas en position fermée
- ▶ Vanne à robinet double, une entrée pour deux sorties
- ▶ Mini vanne papillon, faible encombrement
- ▶ Vanne coulissante, la purge et la fermeture s'effectuent simultanément en couissant la bague sur le corps de la vanne



ÉTANCHÉITÉ

Grâce au forgeage à chaud, les parois du corps de vanne sont exemptes de micro fuites.

Le PTFE pur non régénéré est auto-lubrifiant et élastique.

Les joints d'axe en PTFE garantissent une étanchéité parfaite et une utilisation sans entretien.

FACILITÉ DE MANIPULATION

La longueur et la souplesse du levier facilitent les ouvertures et fermetures fréquentes de la vanne.

L'axe de manœuvre ne traverse pas la bille, il ne subit aucune pression d'air, pas de risque d'éjection.

EXCELLENTE SOLIDITÉ

La pureté du laiton utilisé CW617N, le matriçage à chaud et le soin apporté au montage garantissent un corps de vanne très résistant. Les joints en FPM résistent à une large gamme d'applications.

RÉSISTANCE À LA CORROSION

Le traitement nickel du corps de la vanne ainsi que le cadmiage de la poignée assurent une très grande résistance à la corrosion.

PRESSION ET TEMPÉRATURE

Les matériaux utilisés autorisent une pression de service de 40 bar et une température de + 150°C (suivant modèles).

SANS SILICONE

La garantie sans silicone permet d'utiliser les mêmes vannes pour toutes les applications y compris en ambiance peinture.



CARACTÉRISTIQUES TECHNIQUES

- > Pression de service à froid :
 - 40 bar jusqu'à G 1
 - 32 bar du filetage G 1 □ au filetage G 2
 - 25 bar jusqu'au filetage G 3
- > Température : - 20°C à + 150°C
- > Corps et raccord en laiton de qualité, conforme aux spécifications CW617N matriçés à chaud, sablés nickelés
- > Siège auto-lubrifiant en PTFE pur à rebords flexibles
- > Bille en laiton chromé dur
- > Joints FPM
- > Axe en laiton
- > Lubrifiant sans silicone sur tous les joints
- > Poignée amovible en acier au carbone revêtue d'une gaine isolante PVC bleu marquée PrevoSt.

VANNE PROGRAMMABLE POUR RÉSEAU AIR COMPRIMÉ

UN “ÉCONOMISEUR D’AIR”

Les circuits d’air sont sujets à de multiples fuites (purges, matériels anciens...) qui provoquent la mise en route du compresseur de façon superflue et coûteuse.

Installée en sortie de compresseur, la vanne ouvre et ferme automatiquement l’arrivée d’air selon des horaires de travail programmés sur le temporisateur. Elle isole le compresseur du reste de l’installation.

FONCTIONNEMENT

- ▶ Raccordement de la vanne au circuit : G 1 Gaz BSP femelle
- ▶ Raccordement électrique : 230 V
- ▶ Vanne à boisseau sphérique
- ▶ Temporisateur digital
- ▶ Programmation des heures d’ouverture et de fermeture sur 7 jours
- ▶ Sélection possible de 8 heures d’ouverture et de 8 heures de fermeture différentes par jour
- ▶ Enregistrement par boutons de sélection
- ▶ Affichage des données sur écran de contrôle

AVANTAGES

- ▶ Hors des heures de travail, le circuit n’est plus sous pression : préservation des composants
- ▶ Le compresseur ne démarre pas inutilement : économie (électricité, maintenance...)
- ▶ Fermeture automatique du circuit d’air : pas de risque d’oublis
- ▶ Gestion programmable, 7 jours/7, week-ends inclus
- ▶ Ouverture automatique progressive de la vanne pour éviter le coup de bélier
- ▶ Facilité de programmation des horaires choisis
- ▶ Choix de 3 modes de fonctionnement :
 - application d’un programme
 - vanne ouverte en permanence
 - vanne fermée en permanence (période de vacances).



COMMANDES ET CONTRÔLE DU TEMPORISATEUR

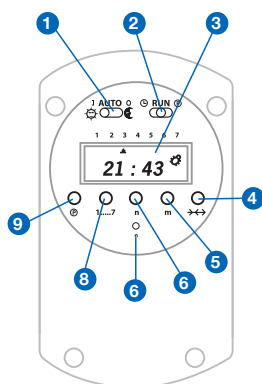





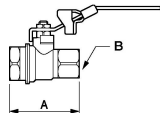

- 1 Mode de travail :
 - AUTO - Automatique selon les horaires choisis
 - I - La vanne est ouverte en permanence
 - O - La vanne est fermée en permanence
- 2 Mode programmation des données
- 3 Affichage digital
- 4 Bouton d’arrêt de programme (la vanne restera fermée jusqu’au nouvel appui sur ce bouton)
- 5 Programmation des minutes
- 6 Programmation des heures
- 7 Mise à 0 des données enregistrées
- 8 Programmation des jours
- 9 Enregistrement des données

VANNES À BOISSEAU SPHERIQUE

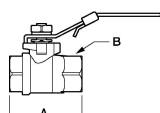
Vanne Passage intégral	Billes Laiton chromé dur	Matière Corps Laiton matricé	Robustesse	Pression P.N. 40 bar	Température Laiton -20°C à + 150°C	Matière Siège/garniture Teflon PTFE	
		A	B	C	DESIGNATION	REFERENCE	
Vanne laiton femelle/femelle PN 40							
		39	20		G 1/4	RSI 13	
		39	20		G 3/8	RSI 17	
		50	25		G 1/2	RSI 21	
		54	31		G 3/4	RSI 27	
		67	38		G 1	RSI 34	
		77	48		G 1 1/4	P.N. 32 bar	RSI 42
		90	54		G 1 1/2	P.N. 32 bar	RSI 49
		106	66		G 2	P.N. 32 bar	RSI 60
		136	85		G 2 1/2	P.N. 25 bar	RSI 76
		157	99		G 3	P.N. 25 bar	RSI 90
Vanne laiton mâle/mâle PN 40							
		39	20		G 1/4	RSIM 13	
		39	20		G 3/8	RSIM 17	
		50	25		G 1/2	RSIM 21	
		54	31		G 3/4	RSIM 27	
		67	38		G 1	RSIM 34	
		Vanne laiton mâle/femelle PN 40					
		39	20		G 1/4	RSIMF 13	
		39	20		G 3/8	RSIMF 17	
		50	25		G 1/2	RSIMF 21	
		54	31		G 3/4	RSIMF 27	
		67	38		G 1	RSIMF 34	
		Vanne papillon mâle/mâle					
					Pressions : Eau : 25 bar, Air : 6 bar		
		60	25		G 1/2	RSIM 21PAP	
		69	31		G 3/4	RSIM 27PAP	
Vanne à décompression femelle/femelle							
					Système de décompression automatique Pression nominale : 14 bar		
		45	20		G 1/4	VDA 13	
		45	20		G 3/8	VDA 17	
		59	25		G 1/2	VDA 21	
		64	31		G 3/4	VDA 27	
		81	40		G 1	VDA 34	

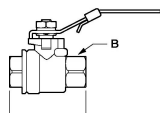
VANNES À BOISSEAU SPHERIQUE

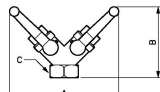
Vanne Passage intégral	Billes Laiton chromé dur	Matière Corps Laiton matricé	Robustesse			Température Laiton -20°C à + 150°C	Matière Siège/garniture Teflon PTFE
		A	B	C	DESIGNATION	REFERENCE	
Vanne cadenassable à décompression							
					Vanne Cadenassable Système de décompression automatique Pression nominale : 14 bar		
		45	20		G 1/4	VCA 13	
		45	20		G 3/8	VCA 17	
		59	25		G 1/2	VCA 21	
		64	31		G 3/4	VCA 27	
81	40		G 1	VCA 34			
Vanne Inox cadenassable (Inox 316)							
					Vanne cadenassable Pressions : Eau : 64 bar, Air : 6 bar Matière : Inox 316 L		
		55	22		G 1/4	VIC 13	
		55	24		G 3/8	VIC 17	
		65	26		G 1/2	VIC 21	
		76	33		G 3/4	VIC 27	
84	41		G 1	VIC 34			
Vanne Inox cadenassable à décompression							
					Vanne Cadenassable Système de décompression automatique Pression : Air : 6 bar Matière : Inox 316 L		
		55	22		G 1/4	VICA 13	
		55	24		G 3/8	VICA 17	
		65	26		G 1/2	VICA 21	
		76	33		G 3/4	VICA 27	
89	40		G 1	VICA 34			
Cadenas à clef							
					Boucle de 30 mm	CADENAS	
Vanne à robinets doubles							
					PN 16 bar Température d'utilisation : - 10°C à + 110°C		
		172	107	31	G 1/2	2xG 3/8	RD 17
		173	107	31	G 3/4	2xG 1/2	RD 21
		174	115	47	G 1	2xG 3/4	RD 27
183	115	47	G 1 1/4	2xG 1	RD 34		

AUTRES VANNES

Vanne	Matière Corps laiton	Robustesse			Applications multiples	Fluide Air, Eau, fluides inertes	
		A	B	C	DESIGNATION	REFERENCE	
Mini-vanne papillon femelle/femelle (PN 16)							
					Passage réduit Température d'utilisation : - 20°C à + 90°C Matière : laiton chromé		
		42	21		G 1/8	FSI 10	
		42	21		G 1/4	FSI 13	
		42	21		G 3/8	FSI 17	
		47	25		G 1/2	FSI 21	
Mini-vanne papillon mâle/femelle (PN 16)							
					Passage réduit Température d'utilisation : - 20°C à + 90°C Matière : laiton chromé		
		42	21		G 1/8	MSI 10	
		42	21		G 1/4	MSI 13	
		42	21		G 3/8	MSI 17	
		49	25		G 1/2	MSI 21	
Vanne électropilotée							
					Vanne équipée d'un temporisateur permettant la fermeture et l'ouverture du réseau air comprimé programmable en 24 heures et 7 jours de la semaine. Temps d'ouverture et de fermeture : 30 sec. Température ambiante maxi : 50°C. Température maxi de l'air : 100°C Pression : 16 bar. Protection IP 54		
		82	195	134	G 1 femelle - 230 V - 50 Hz	VPS 34	
Vanne coulissante femelle/femelle - A17							
					Pression maxi : 10 bar Température d'utilisation : -10°C à +80°C		
		58	22	19	Taraudage G 1/4	Matière Laiton nickelé + Aluminium	A17 14
		68	25.5	22	G 3/8	Laiton nickelé + Aluminium	A17 38

Entre griffes 41 mm	Matière Laiton matricé	Pression de service : 10 bar	Gamme étendue	Passage libre Air, eau froide	Anti chocs
------------------------	---------------------------	---------------------------------	---------------	----------------------------------	------------

		A	B	C	DESIGNATION	REFERENCE	
Raccord express filetage mâle							
					Filetage Gaz BSP		
		57	40	14	G 1/4	8-13	EXP M813
		57	40	19	G 3/8	12-17	EXP M1217
		57	41	24	G 1/2	15-21	EXP M1521
		57	41	31	G 3/4	20-27	EXP M2027
		57	44	34	G 1	26-34	EXP M2634
57	46	44	G 1 1/4	33-42	EXP M3342		
Raccord express taraudage femelle							
					Taraudage Gaz BSP		
		57	32	17	G 1/4	8-13	EXP F813
		57	32	21	G 3/8	12-17	EXP F1217
		57	32	26	G 1/2	15-21	EXP F1521
		57	35	33	G 3/4	20-27	EXP F2027
		57	38	38	G 1	26-34	EXP F2634
57	43	46	G 1 1/4	33-42	EXP F3342		
Raccord cannelé pour tuyau							
		57	69		Ø int. Pour tuyau : 7	EXP 7	
		57	69		Ø int. Pour tuyau : 8	EXP 8	
		57	69		Ø int. Pour tuyau : 9	EXP 9	
		57	69		Ø int. Pour tuyau : 10	EXP 10	
		57	69		Ø int. Pour tuyau : 11	EXP 11	
		57	69		Ø int. Pour tuyau : 13	EXP 13	
		57	69		Ø int. Pour tuyau : 16	EXP 16	
		57	69		Ø int. Pour tuyau : 19	EXP 19	
		57	69		Ø int. Pour tuyau : 22	EXP 22	
		57	69		Ø int. Pour tuyau : 25	EXP 25	
Bouchon							
		57	30		Bouchon	EXP BRE	
Collier de serrage de sécurité (acier)							
					Capacité de serrage		
		43	33		14-16	CSS 15	
		44	33		16-18	CSS 17	
		45	33		19-21	CSS 20	
		50	33		22-24	CSS 23	
		56	33		25-27	CSS 26	
		58	33		28-30	CSS 29	
		69	36		31-33	CSS 32	
		69	36		34-36	CSS 36	
		76	48		37-39	CSS 38	
78	48		40-45	CSS 42			
Joints pour raccords express							
					Conditionnement : 100 pièces		
					Joint caoutchouc noir pour raccords express	EXP JCN	
					Joint néoprène rouge pour raccords express (compatibilité: huiles, hydrocarbures, eau chaude)	EXP JNR	

gamme alr

L'ÉNERGIE PNEUMATIQUE EN RÉSEAU

LE SYSTÈME ALR POUR RÉSEAUX D'AIR GARANTIT :

- ▶ Un réseau sans fuite
- ▶ Un débit optimum
- ▶ Une pression adaptée
- ▶ Une installation pérenne
- ▶ Des postes de travail bien alimentés, accessibles et ergonomiques
- ▶ Un air de qualité
- ▶ Des outils performants, épargnés par la corrosion et les polluants
- ▶ Une maintenance de l'installation rapide et facile
- ▶ Une possibilité d'extension du réseau en cas de besoin



Le système **ALR** répond aux besoins en air comprimé dans **tous les secteurs d'activité**.



FACILE ET RAPIDE À MONTER

Insertion du tube dans le raccord par simple emboîtement, puis serrage par écrou.

TRÈS FAIBLES PERTES DE CHARGE

Les débits du système ALR sont optimaux grâce à une surface interne de tube parfaitement lisse, un faible coefficient de frottement et un diamètre de passage maximum.

MATÉRIAU INALTÉRABLE

L'alliage d'aluminium utilisé, associé à une peinture époxy externe et à un traitement intérieur, garantit le tube contre les risques d'oxydation.

COMPATIBILITÉ AVEC LES HUILES DE COMPRESSEURS

L'aluminium, tout comme les technopolymères qui constituent le système ALR, ne présente pas d'incompatibilité au contact des huiles lubrifiantes pour compresseurs.

RÉSISTANCE AUX CHOCS

Les matériaux du système garantissent d'excellentes prestations quant à la résistance mécanique, à la pression interne et aux chocs externes.

ÉTANCHÉITÉ

La connexion tube-raccord avec joint nitrile protégé et l'excellent guidage du tube dans le raccord assurent une parfaite étanchéité de l'ensemble.

100% ÉVOLUTIF

Les matériaux et le type d'assemblage permettent la réalisation d'un système flexible, évolutif, capable de résoudre tous les problèmes d'équipements même les plus complexes.

Le système de montage est simple et rapide et ne requiert pas l'utilisation d'un outillage lourd et coûteux.

FLUIDE VÉHICULÉ

Air comprimé.

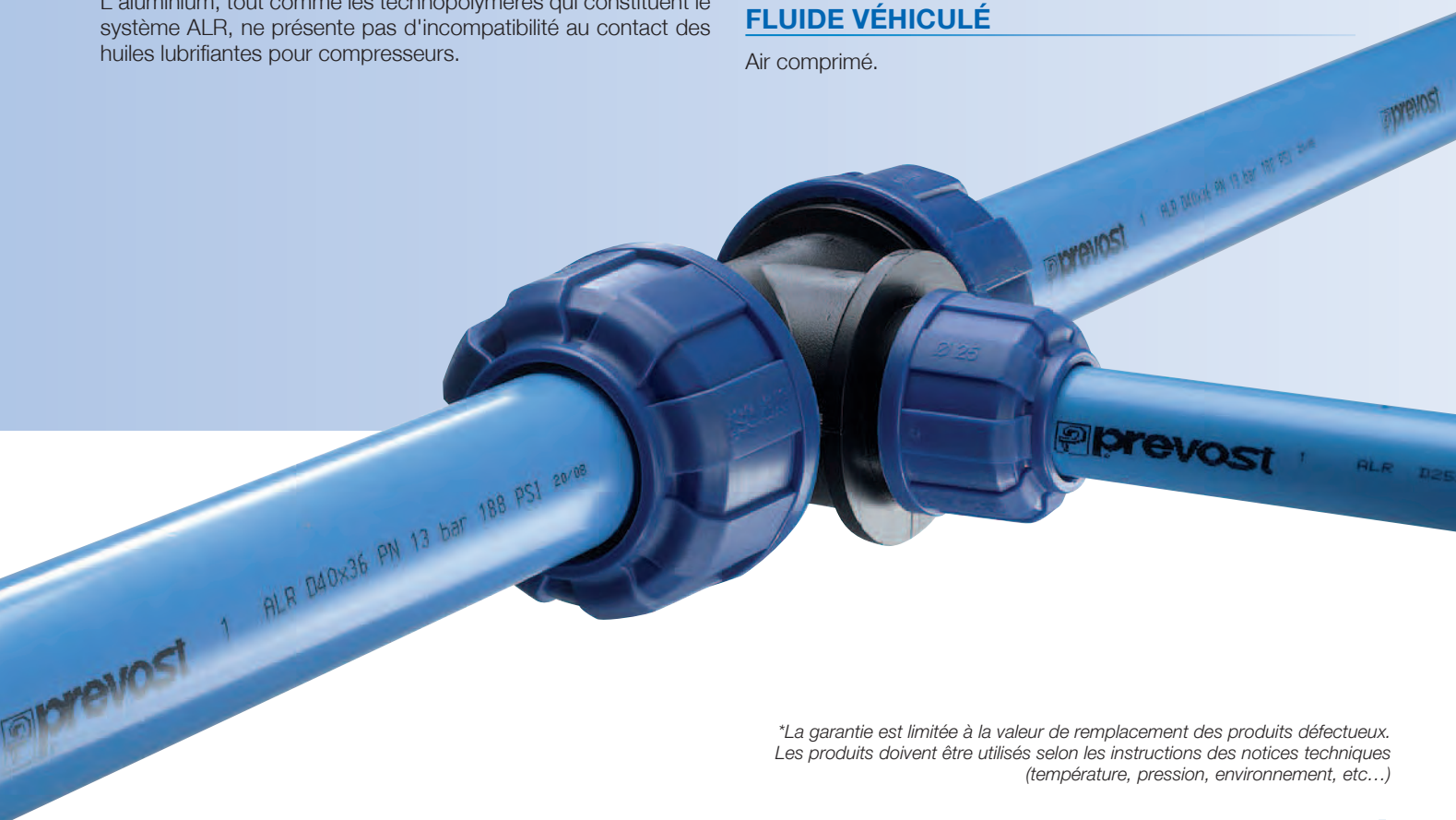

**La garantie est limitée à la valeur de remplacement des produits défectueux. Les produits doivent être utilisés selon les instructions des notices techniques (température, pression, environnement, etc...)*

CARACTÉRISTIQUES TECHNIQUES

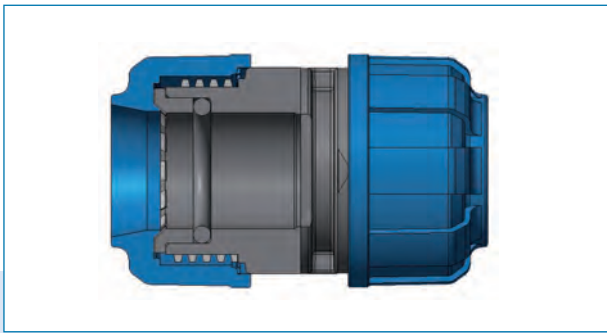

La tenue du tube dans le raccord est assurée par un système de bague en acier inox dont les griffes pénètrent dans la matière aluminium. L'étanchéité est obtenue par un joint nitrile interne. L'insertion du tube dans le raccord est importante. L'étanchéité reste parfaite même dans les conditions les plus sévères.

Fluide véhiculé

- Air comprimé

Tube

- Matériau Alliage d'aluminium ductile
- Densité 2,7 kg/dm³
- Revêtement Peinture époxy
Couleur bleue
- Fluide compatible Air comprimé
- Longueurs de tubes 6 mètres pour tous les diamètres,
3 mètres pour Ø 20, 32 et 40 mm
- Températures : de -20°C à + 60°C
- Pression d'utilisation : 13 bar

Raccord

- Ø 20 à 50 mm
- Corps : Polyamide
- Écrou : Polyamide
- Bague dentée : Acier inox 316 L
- Joint : Nitrile
- Fluide compatible : Air comprimé
- Ø 63 à 80 mm
- Corps : alliage d'aluminium
- Écrou : alliage d'aluminium
- Bague dentée : Acier inox 316 L
- Joint : Nitrile
- Fluide compatible : Air comprimé

Courbe de pression de l'air comprimé en fonction de la température

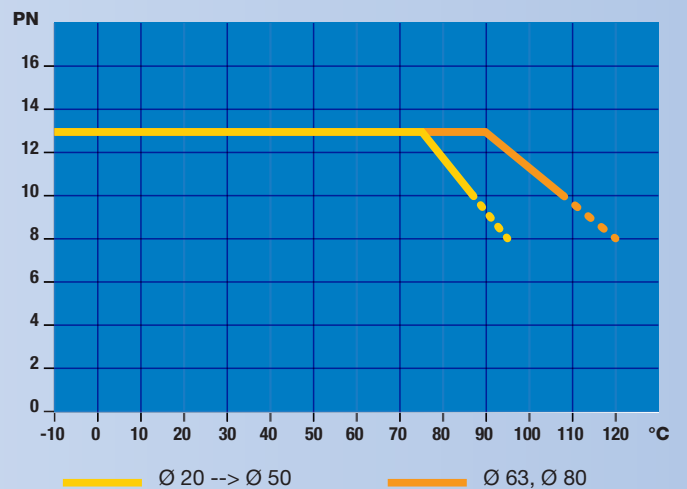

RÈGLES DE BASE DE L'INSTALLATION

► **PLAN et DEVIS
SUR DEMANDE**
suivant votre projet d'installation

Le réseau principal doit être bouclé et équipé de vannes d'isolement.

Le diamètre de la canalisation principale (canalisation primaire) sera suffisamment important pour éviter les pertes de charge et répondre aux extensions futures.

La canalisation primaire doit être fixée avec une pente de **1 %** afin de diriger les condensats vers les points bas (purges).

La canalisation sera fixée avec un nombre suffisant de colliers coulissants pour assurer son maintien tout en permettant la dilatation ou la contraction du tube (réf. AVR CI, p. 185).

Les condensats résiduels seront évacués de la ligne principale par des descentes directes réalisées sous le tube et équipées d'un système de purge (p. 189).

Les brides de piquage permettront de véhiculer un air sec aux postes d'utilisation en prélevant l'air par la partie frontale de la canalisation primaire (p. 177).

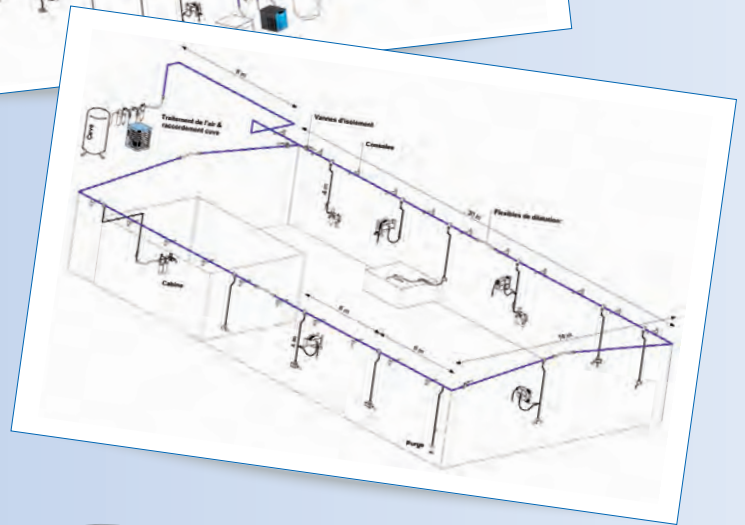

CALCUL DU RÉSEAU

Le calcul du diamètre du tube s'effectue en tenant compte :

- du débit souhaité (perte de charge maxi de 5 % par rapport à la pression d'entrée)
- de la longueur de la canalisation principale

Diamètre du tube en fonction du débit

Le tableau ci-dessous permet de définir le diamètre du tube (en mm) en fonction de la longueur totale de la canalisation et du débit (en m³/h) :

Compresseur kw	Débit			Longueur										
	Nm ³ /h	NI/min	cfm	50 m 164 ft	100 m 328 ft	150 m 492 ft	300 m 984 ft	500 m 1 640 ft	750 m 2 460 ft	1 000 m 3 280 ft	1 300 m 4 265 ft	1 600 m 5 240 ft	2 000 m 6 561 ft	
> 1.5 - 7.5	10	167	6	20	20	20	20	20	20	20	20	25	25	25
	30	500	18	20	20	20	25	25	25	25	25	25	25	32
	50	833	29	20	25	25	25	25	25	25	25	25	25	32
> 7.5 - 30.0	70	1167	49	20	25	25	25	32	32	40	40	40	40	50
	100	1667	50	25	25	32	32	32	40	40	40	50	50	63
	150	2500	88	32	32	32	32	40	40	50	50	63	63	80
	250	4167	147	32	32	40	40	50	50	63	63	80	80	80
> 30 - 75	350	5883	206	32	40	40	50	50	63	63	63	80	80	80
	500	8333	294	40	50	50	50	50	63	63	80	80	80	80
	750	12500	441	50	50	60	60	60	63	80	80	80	80	80
	1000	16667	589	50	50	50	50	63	80	80	80	80	80	80
> 75 - 315	1500	25000	833	50	50	63	63	63	80	80	80	80	80	80
	2000	29167	1030	50	50	63	63	80	80	80	80	80	80	80
	3000	50000	1766	50	63	63	80	80						

Fixation du réseau

- Les modes de fixation du réseau (*au mur ou au plafond*) sont à sélectionner selon la configuration de l'atelier.
- L'assemblage des différents tubes composant l'installation doit être réalisé de façon à obtenir un alignement parfait, solide et esthétique.

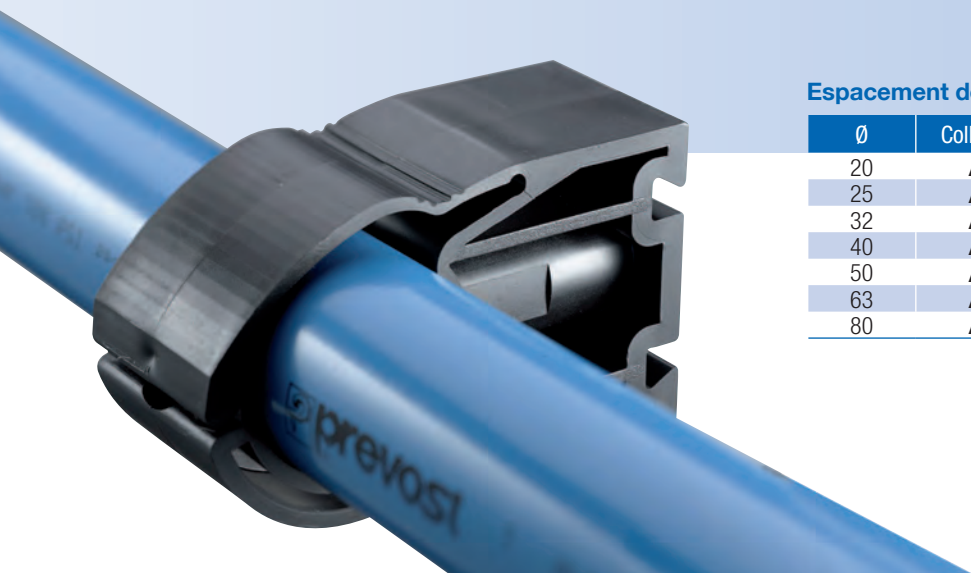
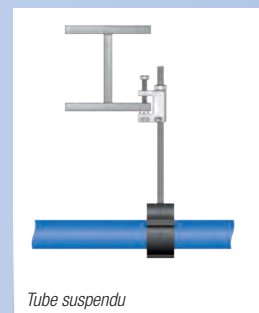
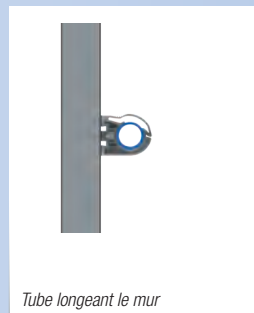
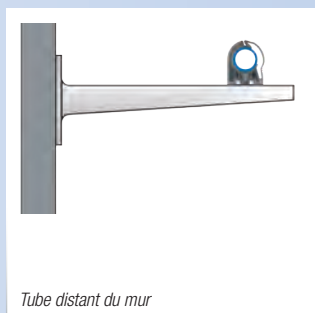

Espacement des supports de fixation

Ø	Colliers de fixation	Espacement des colliers supports
20	AVR CI20	2,5 m
25	AVR CI25	3 m
32	AVR CI32	3,5 m
40	AVR CI40	4 m
50	AVR CI50	4 m
63	AVR CI63	4 m
80	AVR CI80	4 m

PRINCIPE D'ASSEMBLAGE DU SYSTÈME ALR

Couper

La coupe du tube doit être droite. Utilisation d'un coupe tube, réf. ALR CTU.



Chanfreiner le tube

sur l'extérieur du tube pour faciliter l'emboîtement et éviter d'endommager le joint. Un léger chanfreinage interne permettra d'éliminer d'éventuels résidus de coupe.



(pour les Ø 63 et 80, utilisation d'un outil pour couper et chanfreiner, réf. ALR CTCHE6380).

Dévisser

l'écrou de quelques tours, puis emboîter le tube en exerçant une légère rotation pour atteindre le fond de butée du raccord.



Revisser

l'écrou manuellement, puis le bloquer d'un demi-tour à l'aide de la clé, réf. ALR CLE.



Pour le démontage

Dévisser l'écrou et sortir le tube du raccord.



Descentes

Bride de piquage

La bride de piquage permet la réalisation d'une descente d'alimentation au poste de travail.

Elle joue le rôle de l'ancien "col de cygne" et permet d'obtenir un air moins chargé en eau et condensats.

Le montage, facile, s'effectue en un seul perçage.



Liaison murale

La liaison murale coudée permet de compenser les différences d'entraxes.

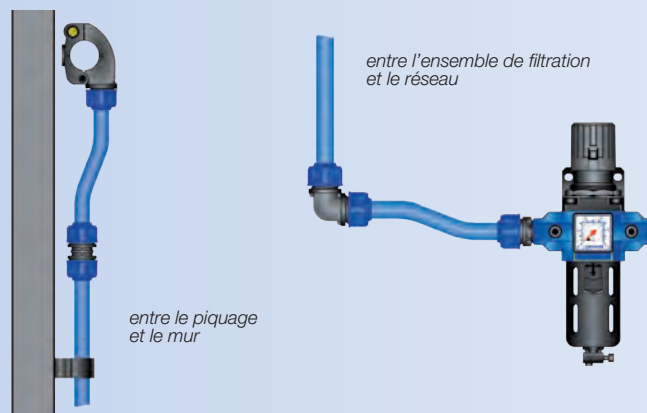

Points Bas

Les points bas sont nécessaires à une bonne évacuation des condensats.

Ces descentes doivent être positionnées aux endroits stratégiques le long du réseau.

Les condensats peuvent être évacués par tout système de purge classique - purge électronique, purge automatique, vanne - (p. 183 et 365 à 369).



Des vannes de sectionnement permettront d'isoler certaines parties du réseau pour en assurer la maintenance.



Dilatation des matériaux

Comme tout autre matériau, l'aluminium peut subir un phénomène de dilatation ou de contraction dû aux variations thermiques.

Pour compenser ces éventuelles expansions, il est conseillé de prévoir des dispositifs d'absorption sur la canalisation concernée.

Un flexible souple jouera ce rôle.

Il permettra également de réaliser des changements de direction (*angles*) ou de contourner les obstacles présents dans l'atelier (*pilliers, poutres etc...*).

Il est recommandé d'insérer un point fixe (**réf. CPF**) au milieu de chaque segment rectiligne dans le but de répartir la dilatation de part et d'autre de ce point.

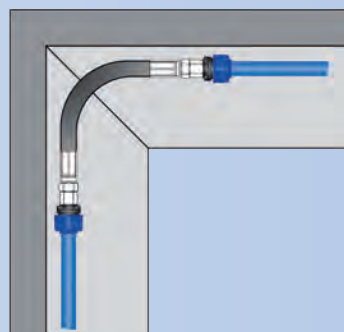

Flexibles pour compenser les dilatations et contractions du réseau (dues aux variations de température)				
Mâles coniques Standard	Filetage BSP	Longueur (m)	Pression utilisation maxi (bar)	Rayon de courbure (mm)
LAM 27	R 3/4	0.75	105	240
LAM 34	R 1	0.75	88	300
LAM 42	R 1 1/4	1.1	63	420
LAM 49	R 1 1/2	1.25	50	500
LAM 60	R2	1	40	630

Flexibles pour connexion du compresseur au réseau							
Femelles Standard	Mâles coniques Standard	Femelles Sécurité	Mâles coniques Sécurité	Filetage BSP	Longueur (m)	Pression utilisation	Rayon de courbure (mm)
LEF 17	LEM 17	LEF 179	LEM 179	3/8	1.5	180	130
LEF 21	LEM 21	LEF 21S	LEM 21S	1/2	1.5	160	180
LEF 27	LEM 27	LEF 27S	LEM 27S	3/4	1.5	105	240
LEF 34	LEM 34	LEF 34S	LEM 34S	1	1.5	88	300
LEF 42	LEM 42			1 1/4	2.2	60	420
LEF 49	LEM 49			1 1/2	2.5	50	500
LEF 60	LEM 60			2	2	80	630

Dilatation de l'aluminium

Coefficient de dilatation : 0,024 mm par mètre et par degré C.

La dilatation se calcule de la façon suivante :

C = Coefficient de dilatation
L = Longueur de la ligne droite (entre 2 points fixes)
ΔT° = Écart entre la température ambiante maximale et minimale en ° C.

DL = Dilatation globale

Soit **DL = C x L x ΔT°**

Exemple : une ligne de 20 mètres posée en Ø 40 mm, à une température ambiante de 15°C pouvant subir une température maxi de 40°C

Soit 25° de différence

DL : 0,024 x 20 (m) x 25° (45° C – 15° C) = 12 mm.





Placée sur une canalisation secondaire, l'applique murale **PREVO S1** offre la possibilité de raccordement rapide pour 2 applications.

- Entrée d'air : G 1/2 ou G 3/4
- Matériau : Alliage d'aluminium
- Fixation murale par 4 points
- Applique équipée d'une purge manuelle montée étanche
- Connexion à la canalisation ALR en Ø 20 et Ø 25 mm par :
 - Raccord droit métallique tube/filetage, réf. ALR MM
 - ou
 - Jonction pour applique réf. ALR JF avec un raccord union tube/tube réf. ALR UN
(Jonction monobloc en alliage d'aluminium)
 - * en option

- Sortie d'air : 2 raccords de sécurité mono-impulsion **prevoS1**

- Raccords **prevoS1** anti-coup de fouet conforme à la norme ISO 4414 garantissant la protection de l'utilisateur
- Corps orientables permettant le positionnement du bouton
- Connexion et déconnexion rapides et sans effort assurant une grande souplesse d'utilisation

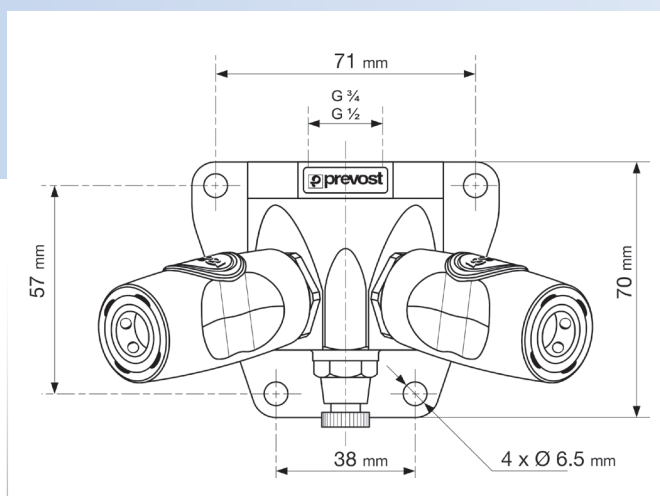

CONCEPT ALR

RESEAUX ALUMINIUM

POUR AIR COMPRIME

Compatible Huiles compresseurs	Pression P.N.13 bar à 40°C	Matière Tube: aluminium Peinture époxy	Anti chocs	Matière Raccord : polyamide ou alu. Griffes inox	Dépression - 0,3 bar à 20°C	Montage Facile
-----------------------------------	-------------------------------	--	------------	--	--------------------------------	-------------------

		A	B	C	DESIGNATION	REFERENCE		
ALR TU - Tube rigide aluminium								
					En longueur de 6 mètres, la livraison se fait à partir d'une commande de 3 barres minimum; toutes références confondues.			
					Ø ext.tube	longueur		
		1.5			20	3 m.	ALR TU20L3	
		1.5			20	6 m.	ALR TU20L6	
		1.5			25	3 m.	ALR TU25L3	
		1.5			25	6 m.	ALR TU25L6	
		1.5			32	3 m.	ALR TU32L3	
		1.5			32	6 m.	ALR TU32L6	
		2			40	3 m.	ALR TU40L3	
		2			40	6 m.	ALR TU40L6	
2			50	6 m.	ALR TU50L6			
2			63	6 m.	ALR TU63L6			
2.4			80	6 m.	ALR TU80L6			
ALR LM - Tube de liaison cintré long								
					Pour tube Ø ext.			
		150	415	20	20		ALR LM20	
		160	470	25	25		ALR LM25	
ALR LMC - Tube de liaison cintré court								
					Pour adaptation sur canalisation secondaire.			
					Pour tube Ø ext.			
		90	480	20	20		ALR LMC20	
		75	485	25	25		ALR LMC25	
ALR BP - Bride de piquage pour tube								
					Canalisation primaire Ø ext.	Descente Ø ext.		
		110	70		25	20		ALR BP2520
		110	70		32	20		ALR BP3220
		121	83		40	20		ALR BP4020
		121	87		40	25		ALR BP4025
		145	111		50	20		ALR BP5020
		145	111		50	25		ALR BP5025
		147	118		63	20		ALR BP6320
		147	118		63	25		ALR BP6325
		147	118		63	32		ALR BP6332
222	168		80	20		ALR BP8020		
222	168		80	25		ALR BP8025		
222	168		80	32		ALR BP8032		
AVR BT - Bride de piquage taraudée								
					Canalisation primaire Ø ext.	Taraudage		
		110	70		25	G 1/2		AVR BT2512
		110	70		32	G 1/2		AVR BT3212
		121	83		40	G 1/2		AVR BT4012
		121	87		40	G 3/4		AVR BT4027
		150	105		50	G 1/2		AVR BT5012
		150	105		50	G 3/4		AVR BT5027
		150	111		63	G 1/2		AVR BT6312
		150	111		63	G 3/4		AVR BT6327
		150	111		63	G 1		AVR BT6334

CONCEPT ALR

RESEAUX ALUMINIUM

POUR AIR COMPRISE

Compatible Huiles compresseurs	Pression P.N.13 bar à 40°C	Matière Tube: aluminium Peinture époxy	Anti chocs	Matière Raccord : polyamide ou alu. Griffes inox	Dépression - 0,3 bar à 20°C	Montage Facile
-----------------------------------	-------------------------------	--	------------	--	--------------------------------	-------------------

		A	B	C	DESIGNATION	REFERENCE	
ALR UN - Union simple pour tube							
					Pour tube Ø ext.		
		103	47		20	ALR UN20	
		104	53		25	ALR UN25	
		122	65		32	ALR UN32	
		138	80		40	ALR UN40	
		150	93		50	ALR UN50	
ALR UNA - Union simple aluminium pour tubes Ø 63 et Ø 80 mm							
					Pour tube Ø ext.		
		183	98.5		63	ALR UNA63	
		235	116		80	ALR UNA80	
ALR MR - Réduction de tube							
					Pour tube Ø ext.	Pour tube Ø ext.	
		98	53		25	20	ALR MR2520
		114	65		32	25	ALR MR3225
		123	80		40	32	ALR MR4032
		146	93		50	40	ALR MR5040
ALR 9C - Coude égal 90°							
					Pour tube Ø ext.		
		83	47		20	ALR 9C20	
		88	53		25	ALR 9C25	
		109	65		32	ALR 9C32	
		129	80		40	ALR 9C40	
		150	93		50	ALR 9C50	
ALR 9CA - Coude égal 90° aluminium pour tubes Ø 63 et Ø 80 mm							
					Pour tube Ø ext.		
		177	98.5		63	ALR 9CA63	
		210	116		80	ALR 9CA80	
ALR 4C - Coude égal 45°							
					Pour tube Ø ext.		
		100	47		20	ALR 4C20	
		113	53		25	ALR 4C25	
		135	65		32	ALR 4C32	
		158	80		40	ALR 4C40	
		180	93		50	ALR 4C50	

CONCEPT ALR

RESEAUX ALUMINIUM

POUR AIR COMPRIME

Compatible Huiles compresseurs	Pression P.N.13 bar à 40°C	Matière Tube: aluminium Peinture époxy	Anti chocs	Matière Raccord : polyamide ou alu. Griffes inox	Dépression - 0,3 bar à 20°C	Montage Facile
-----------------------------------	-------------------------------	--	------------	--	--------------------------------	-------------------

		A	B	C	DESIGNATION		REFERENCE
ALR BO - Bouchon							
					Pour tube Ø ext.		
		56	47		20		ALR BO20
		58	53		25		ALR BO25
		65	65		32		ALR BO32
		76	81		40		ALR BO40
		83	93		50		ALR BO50
ALR BOA - Bouchon aluminium pour tubes Ø 63 et Ø 80 mm							
					Pour tube Ø ext.		
		135	98.5		63		ALR BOA63
		165	116		80		ALR BOA80
ALR TE - Té égal pour tubes							
					Pour tube Ø ext.		
		124	83	47	20		ALR TE20
		132	88	53	25		ALR TE25
		158	107	65	32		ALR TE32
		182	129	80	40		ALR TE40
		206	150	93	50		ALR TE50
ALR TEA - Té égal aluminium pour tubes Ø 63 et Ø 80 mm							
					Pour tube Ø ext.		
		254	176		63		ALR TEA63
		325	214		80		ALR TEA80
ALR TR - Té réduit pour tubes							
					Pour tube Ø ext.	Pour tube Ø ext.	
		132	47		25	20	ALR TR2520
		158	47		32	20	ALR TR3220
		158	107		32	25	ALR TR3225
		182	52		40	25	ALR TR4025
		182	65		40	32	ALR TR4032
		205	65		50	32	ALR TR5032
		205	80		50	40	ALR TR5040
ALR TT - Té taraudé							
					Pour tube Ø ext.	Taraudage Gaz BSP	
		124	85	42	20	G 1/2	ALR TT2012
		132	92	42	25	G 1/2	ALR TT2512

CONCEPT ALR

RESEAUX ALUMINIUM

POUR AIR COMPRIME

Compatible Huiles compresseurs	Pression P.N.13 bar à 40°C	Matière Tube: aluminium Peinture époxy	Anti chocs	Matière Raccord : polyamide ou alu. Griffes inox	Dépression - 0,3 bar à 20°C	Montage Facile
-----------------------------------	-------------------------------	--	------------	--	--------------------------------	-------------------



		A	B	C	DESIGNATION		REFERENCE
ALR TTA - Té taraudé aluminium pour tubes Ø 63 et Ø 80 mm							
		254	111.5		Pour tube Ø ext.	Taraudage Gaz BSP	ALR TTA6360
		325	116		63	G 2	ALR TTA8076
					80	G 2 1/2	
ALR PM - Raccord droit polyamide mâle fileté conique							
		66	47		Pour tube Ø ext.	Filetage Gaz BSP	ALR PM2012
		66	47		20	R 1/2	ALR PM2027
		71	53		20	R 3/4	ALR PM2512
		71	53		25	R 1/2	ALR PM2527
		74	53		25	R 3/4	ALR PM2534
		74	53		25	R 1	ALR PM2534
		82	65		32	R 1	ALR PM3234
		86	65		32	R 1 1/4	ALR PM3242
		97	80		40	R 1 1/4	ALR PM4042
		97	80		40	R 1 1/2	ALR PM4049
104	93		50	R 1 1/2	ALR PM5049		
108	93		50	R 2	ALR PM5060		
ALR MM - Raccord droit aluminium mâle fileté conique avec écrou polyamide							
		66	47		Pour tube Ø ext.	Filetage Gaz BSP	ALR MM2012
		66	47		20	R 1/2	ALR MM2027
		73	53		20	R 3/4	ALR MM2534
		73	53		25	R 1/2	ALR MM2534
		85	65		32	R 1 1/4	ALR MM3242
		100	80		40	R 1 1/2	ALR MM4049
		107	93		50	R 2	ALR MM5060
ALR MMA - Raccord droit aluminium mâle fileté conique							
		131	98.5		Pour tube Ø ext.	Filetage Gaz BSP	ALR MMA6376
		149	116		63	R 2 1/2	ALR MMA8076
		149	116		80	R 2 1/2	ALR MMA8090
					80	R 3	
ALR MF - Raccord droit aluminium femelle taraudée avec écrou polyamide							
		68	47		Pour tube Ø ext.	Taraudage Gaz BSP	ALR MF2012
		68	47		20	G 1/2	ALR MF2027
		73	53		20	G 3/4	ALR MF2534
		73	53		25	G 1	ALR MF2534
		85	65		32	G 1 1/4	ALR MF3242
		102	80		40	G 1 1/2	ALR MF4049
105	93		50	G 2	ALR MF5060		

CONCEPT ALR

RESEAUX ALUMINIUM

POUR AIR COMPRIME

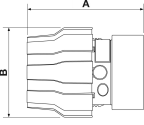

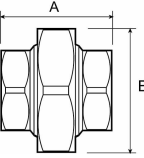

Compatible Huiles compresseurs	Pression P.N.13 bar à 40°C	Matière Tube: aluminium Peinture époxy	Anti chocs	Matière Raccord : polyamide ou alu. Griffes inox	Dépression - 0,3 bar à 20°C	Montage Facile
-----------------------------------	-------------------------------	--	------------	--	--------------------------------	-------------------

		A	B	C	DESIGNATION		REFERENCE
ALR MFA - Raccord droit aluminium taraudé pour tube Ø 63 mm							
		128	98.5		Pour tube Ø ext.	Taraudage Gaz BSP	ALR MFA6376
					63	G 2 1/2	
A3T - Manchon égal femelle tournant (3 pièces)							
		48.5	53		Taraudage		A3T 01
		59	65		G 1		A3T 42
		63.5	73		G 1 1/4		A3T 49
		75.5	89		G 1 1/2		A3T 60
					G 2		

APPLIQUES MURALES PREVO S1

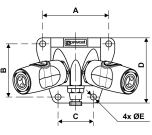
NOUVEAU

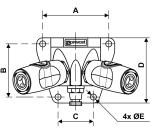
Pression PN 12 bar	Matière applique : alliage d'aluminium	Sécurité anti-coup de fouet	Montage mural - 4 trous de fixation	Purge manuelle intégrée	Possibilité d'orientation des boutons
-----------------------	--	--------------------------------	--	----------------------------	--

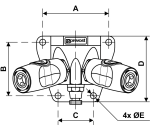





		A	B	C	D	E	DESIGNATION		REFERENCE
Applique murale taraudée - 2 raccords et purge manuelle - Profil ISO B - Passage 6 mm									
		71	57	38	70	6,5	Entrée taraudée	Sortie : 2 raccords	ISI 068103WF
		71	57	38	70	6,5	G 1/2	2 raccords ISI 06	ISI 068104WF
Applique murale taraudée - 2 raccords et purge manuelle - Profil ISO B - Passage 8 mm									
		71	57	38	70	6,5	Entrée taraudée	Sortie : 2 raccords	ISI 088103WF
		71	57	38	70	6,5	G 3/4	2 raccords ISI 08	ISI 088104WF
Applique murale taraudée - 2 raccords et purge manuelle - Profil Européen 7.2 mm									
		71	57	38	70	6,5	Entrée taraudée	Sortie : 2 raccords	ESI 078103WF
		71	57	38	70	6,5	G 3/4	2 raccords ESI 07	ESI 078104WF

APPLIQUES MURALES PREVO S1

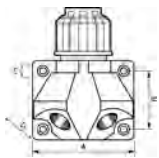

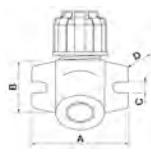
NOUVEAU

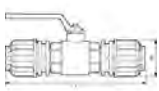
Pression PN 12 bar	Matière applique : alliage d'aluminium	Sécurité anti-coup de fouet	Montage mural - 4 trous de fixation					Purge manuelle intégrée	Possibilité d'orientation des boutons
		A	B	C	D	E	DESIGNATION		REFERENCE
Applique murale taraudée - 2 raccords et purge manuelle - Profil ISO C - Passage 6 mm									
		71	57	38	70	6,5	Entrée taraudée	Sortie : 2 raccords	
							G 1/2	2 raccords CSI 06	CSI 068103WF
		71	57	38	70	6,5	G 3/4	2 raccords CSI 06	CSI 068104WF
Applique murale taraudée - 2 raccords et purge manuelle - Profil ISO C - Passage 8 mm									
		71	57	38	70	6,5	Entrée taraudée	Sortie : 2 raccords	
							G 1/2	2 raccords CSI 08	CSI 088103WF
		71	57	38	70	6,5	G 3/4	2 raccords CSI 08	CSI 088104WF
Applique murale taraudée - 2 raccords et purge manuelle - Profil ARO - Passage 6 mm									
		71	57	38	70	6,5	Entrée taraudée	Sortie : 2 raccords	
							G 1/2	2 raccords ASI 06	ASI 068103WF
		71	57	38	70	6,5	G 3/4	2 raccords ASI 06	ASI 068104WF
Applique murale taraudée - 2 raccords et purge manuelle - Profil British - Passage 6 mm									
		71	57	38	70	6,5	Entrée taraudée	Sortie : 2 raccords	
							G 1/2	2 raccords BSI 06	BSI 068103WF
		71	57	38	70	6,5	G 3/4	2 raccords BSI 06	BSI 068104WF
Applique murale taraudée - 2 raccords et purge manuelle - Profil Truflate - Passage 6 mm									
		71	57	38	70	6,5	Entrée taraudée	Sortie : 2 raccords	
							1/2 NPT	2 raccords USI 06	USI 068203WF
		71	57	38	70	6,5	3/4 NPT	2 raccords USI 06	USI 068204WF
Applique murale taraudée - 2 raccords et purge manuelle - Profil Truflate - Passage 8 mm									
		71	57	38	70	6,5	Entrée taraudée	Sortie : 2 raccords	
							1/2 NPT	2 raccords USI 08	USI 088203WF
							3/4 NPT	2 raccords USI 08	USI 088204WF



ACCESSOIRES DE MONTAGE POUR RESEAU ALR

Compatible Huiles compresseurs		Pression PN 13 bar à 40 °C		Dépression - 0,3 bar à 20°C		Matière Tube : aluminium ductile. Peinture epoxy		Anti chocs		Matière Raccord : polyamide Griffe : acier inox		Montage facile	
		A	B	C	D	DESIGNATION		REFERENCE					
ALR Y - Applique murale avec 1 entrée pour tube et 2 sorties taraudées													
		100	52	7	79	1 entrée pour tube	2 sorties	Ø 20	G 1/2	ALR Y20			
		100	52	7	79	Ø 25	G 1/2	ALR Y25					
		100	52	7	79	Ø 20	G 1/2 avec purge man.	ALR YP20					
		100	52	7	79	Ø 25	G 1/2 avec purge man.	ALR YP25					
ALR M - Applique murale 1 entrée pour tube et 1 sortie taraudée													
		81	45	8	77	1 entrée pour tube	1 sortie taraudée	Ø 20	G 1/2	ALR M2012			
ALR RIM - Vanne pour tube ALR avec raccords aluminium													
		175	46					20		ALR RIM20			
		195	51.5					25		ALR RIM25			
		225	65					32		ALR RIM32			
		270	80					40		ALR RIM40			
		305	92					50		ALR RIM50			
ALR CLE - Clé de serrage													
						Pour raccord							
								20 à 32		ALR CLE32			
									40 à 63		ALR CLE63		
									63 et 80		ALR CLE80		
ALR ECG - Ecrou griffes													
								20		ALR ECG20			
								25		ALR ECG25			
									32		ALR ECG32		
									40		ALR ECG40		
									50		ALR ECG50		









ACCESSOIRES DE MONTAGE POUR RESEAU ALR

Compatible Huiles compresseurs	Pression PN 13 bar à 40 °C	Dépression - 0,3 bar à 20°C	Matière Tube : aluminium ductile. Peinture epoxy				Anti chocs	Matière Raccord : polyamide Griffe : acier inox	Montage facile
		A	B	C	D	DESIGNATION		REFERENCE	
ALR EAG - Ecrou aluminium griffes									
					63			ALR EAG63	
					80			ALR EAG80	
ALR JTB - Entretoise joint									
					20			ALR JTB20	
					25			ALR JTB25	
					32			ALR JTB32	
					40			ALR JTB40	
					50			ALR JTB50	
ALR JAB - Bagues joint									
					Pour raccord				
					63			ALR JAB63	
					80			ALR JAB80	

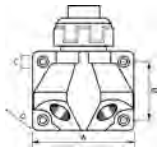
ACCESSOIRES POUR RESEAUX ALR ET PVR

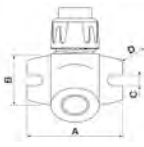

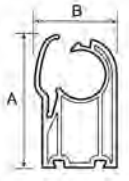

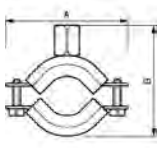

Compatible Huiles compresseurs	Pression PN 13 bar à 40°C					Anti chocs	Montage Facile	
		A	B	C	D	DESIGNATION		REFERENCE
AVR AFF - Applique murale taraudée/taraudée								
						Laiton nickelé		
						50	41	Entrée taraudée G 1/2

ACCESSOIRES POUR RESEAUX ALR ET PVR

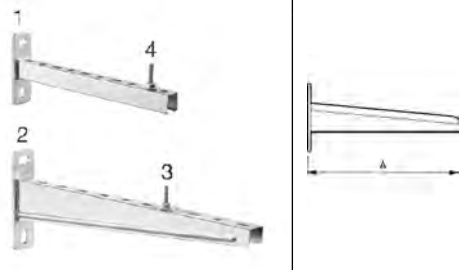

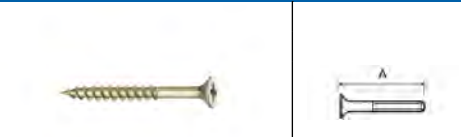
Compatible Huiles compresseurs		Pression PN 13 bar à 40°C				Anti chocs	Montage Facile
		A	B	C	D	DESIGNATION	REFERENCE
AVR AFM - Applique murale fileté/tarudée							
						Laiton nickelé	
		48.5	41			Entrée fileté	Sortie tarudée
		60	47			G 1/2	G 1/2
						G 3/4	G 3/4
							AVR AFM12
							AVR AFM27
AVR Y - Applique murale double tarudée/tarudée							
						Tarudage 1 entrée	Tarudage 2 sorties
		100	52	7	79	G 1/2	G 1/2
		100	52	7	79	G 3/4	G 1/2
		100	52	7	79	G 1/2	G 1/2 avec purge man.
		100	52	7	79	G 3/4	G 1/2 avec purge man.
							AVR Y1212
							AVR Y2712
							AVR Y1212P
							AVR Y2712P
AVR M - Applique murale simple tarudée/tarudée							
						Tarudage 1 entrée	Tarudage 1 sortie
		81	45	8	77	G 1/2	G 1/2
							AVR M1212
AVR CI - Collier de fixation							
						- Tête hexagonale de Ø 8 mm à l'intérieur du collier - Livré avec un écrou M8 pour la fixation du collier sur tige filetée ou maintien de la tête de la vis VBA	
		50	31			20	AVR CI20
		54	39			25	AVR CI25
		59	49			32	AVR CI32
		100	61			40	AVR CI40
		107	76			50	AVR CI50
		114	93			63	AVR CI63
		155	119			80	AVR CI80
Colliers pour point fixe tarudé M8							
		64	51			20	CPF 20
		70	52			25	CPF 25
		78	60			32	CPF 32
		91	67			40	CPF 40
		100	73			50	CPF 50
		102	83			63	CPF 63
		124	116			80	CPF 80

ACCESSOIRES POUR RESEAUX ALR ET PVR

Compatible Huiles compresseurs	Pression PN 13 bar à 40°C	Anti chocs	Montage Facile
-----------------------------------	------------------------------	------------	-------------------

		A	B	C	D	DESIGNATION	REFERENCE
Console métallique de support							
		180				Longueur 180 mm	Poids max. réparti sur la longueur 133 kg (1)
		420				420 mm	56,4 kg (1)
		510				510 mm	75 kg (2)
		-	-			Vis de fixation M8 (3) sur console CS 500	
		-	-			Vis de fixation (4) pour consoles CS 180L - CS 310L - CS 420L	
					300 mm	80 kg (1)	CS 310L
Clips de fixation taraudé M8							
		47	45			3 à 8 mm (1)	CP 38
		53	45			8 à 14 mm (1)	CP 814
		58	45			14 à 20 mm (1)	CP 1420
		30	34			0 à 16 mm M6 ou traversant (2)	
Vis VBA Ø 6 mm							
		60				Longueur 60 mm	TVB 660
		90				Longueur 90 mm	TVB 690
Vis fileté Ø 8 mm							
		60				Longueur 60 mm	TVM 860
Tire-fond Ø 8 mm							
		50				Longueur 50 mm	TTF 850
		80				Longueur 80 mm	TTF 880
Goujon galvanisé fileté M8							
		50				Pour tous types de matériaux Longueur 50 mm	PV 80
		80				Longueur 80 mm	PV 880
Tige de liaison							
		77				M8	TL M8

ACCESSOIRES POUR RESEAUX ALR ET PVR

Compatible Huiles compresseurs		Pression PN 13 bar à 40°C				Anti chocs	Montage Facile
		A	B	C	D	DESIGNATION	REFERENCE
Tige filetée							
		100				Longueur : 1m - M8	TF M8100
		30				Union pour tige filetée M8	TL RM8
		-				Ecrou M8	TE M8
Scie cloche pour perçage tubes ALR et PVR							
						Outil de perçage pour pose de brides de piquage	
						Perçage pour piquage Ø de perçage	
						Tubes Ø 25 et Ø 32 mm 14 mm	AVR SP14
					Tubes Ø 40 à 80 17 mm	AVR SP17	
Coupe tube							
						Pour tube Ø ext.	
						1 - 20 à 40 - Coupe tube pour tube PVR	PVR CTU40
						2 - 50 à 110 - Coupe tube pour tube PVR	PVR CTU110
						2 - 20 à 63 - Coupe tube pour tube ALR	ALR CTU63
AVR CHE - Outil pour chanfreiner (chanfrein 15°)							
						Pour tube Ø ext.	
						1 - 20 à 50 mm	AVR CHE50
						2 - 20 à 50 mm	AVR CHE50P
						3 - Ebavurage int./ ext.	AVR CHERAP
						4 - 20 à 110 mm	PVR CHE110
ALR CTCHE - Outil pour couper et chanfreiner les tubes							
						Pour tube Ø ext.	
						63 et 80	ALR CTCHE6380
Ebavureur pour perceuse							
						Fourni avec un adaptateur pour mandrin d'outils à entraînement	
						Pour tube Ø ext.	
						10 à 40 mm	AVR EBA

Matière Caoutchouc synthétiques, tresse acier	Norme ISO 4413 - 1998	Application raccordement Raccords tournants	Résistance Huiles, abrasion, ozone
--	--------------------------	--	---------------------------------------

		Longueur m.	Température °C	Pression maxi. de service (bar)	Filetage Gaz BSP	Rayon de courbure à 20°C (mm)	REFERENCE
Flexibles de compensation des dilations et contractions des réseaux d'air - Raccordements mâles tournants							
	NOUVEAU	0.75	-40° +70° C	105	R 3/4	240	LAM 27
		0.75	-40° +70° C	88	R 1	300	LAM 34
		1.1	-40° +70° C	63	R 1 1/4	420	LAM 42
		1.25	-40° +70° C	50	R 1 1/2	500	LAM 49
		1	-40° +70° C	40	R 2	630	LAM 60
Flexible de liaison - Raccordements femelles tournants							
	NOUVEAU	1.5	-40° +110° C	180	G 3/8	130	LEF 17
		1.5	-40° +110° C	160	G 1/2	130	LEF 21
		1.5	-40° +110° C	105	G 3/4	240	LEF 27
		1.5	-40° +110° C	88	G 1	300	LEF 34
		2.2	-40° +110° C	63	G 1 1/4	420	LEF 42
		2.5	-40° +110° C	50	G 1 1/2	500	LEF 49
		2	-40° +110° C	80	G 2	630	LEF 60
Flexibles de liaison avec câble acier de sécurité - Raccordements femelles tournants							
	NOUVEAU	1.5	-40° + 110°C	180	G 3/8	130	LEF 17S
		1.5	-40° +110° C	160	G 1/2	130	LEF 21S
		1.5	-40° +110° C	105	G 3/4	240	LEF 27S
		1.5	-40° +110° C	88	G 1	300	LEF 34S
Flexibles de liaison - Raccordement mâles tournants							
	NOUVEAU	1.5	-40° +110° C	180	R 3/8	130	LEM 17
		1.5	-40° +110° C	160	R 1/2	180	LEM 21
		1.5	-40° +110° C	105	R 3/4	240	LEM 27
		1.5	-40° +110° C	80	R 1	300	LEM 34
		2.2	-40° +110° C	63	R 1 1/4	420	LEM 42
		2.5	-40° +110° C	50	R 1 1/2	500	LEM 49
		2	-40° +110° C	80	R 2	630	LEM 60
Flexibles de liaison avec câble de sécurité - Raccordements mâles tournants							
	NOUVEAU	1.5	-40° +110° C	180	R 3/8	130	LEM 17S
		1.5	-40° +110° C	160	R 1/2	180	LEM 21S
		1.5	-40° +110° C	105	R 3/4	240	LEM 27S
		1.5	-40° +110° C	88	R 3/4	300	LEM 34S

PURGEURS

Purge automatique	Facilité d'emploi	Entretien réduit	Evacuation Eau, huile, condensats	Haute capacité d'évacuation		
Purge magnétique d'évacuation des condensats						
		140	165	<p>Aucune perte d'air comprimé pendant l'évacuation des condensats. Purge autonome ne nécessitant pas d'alimentation électrique. Mécanisme simple et fiable par commande magnétique. Capacité importante d'évacuation. Installation simple et rapide</p> <p>Corps en aluminium résistant à la corrosion</p> <p>Evacuation des condensats : 200 l/heure</p> <p>2 connexions entrée : G 1/2 femelle</p> <p>Sortie : G 1/8 femelle</p> <p>Valve magnétique</p>	PMA 200	
Purge d'évacuation d'eau automatique à flotteur						
		133	53	28	<p>Purge automatique à flotteur</p> <p>Raccordement entrée : G 1/2</p> <p>Sortie de purge : Ø 8 mm</p> <p>Poids du purgeur : 422 g</p> <p>Pression : 2 à 12 bar</p> <p>Température maxi : 80° C</p>	PAM 21
Purge d'évacuation de condensats automatique "gros débit" - Tarauage entrée G 1/2						
		216	116	<p>Attention : le polycarbonate est incompatible avec les diluants et certaines huiles chargées d'esters</p> <p>Raccordement entrée : G 1/2</p> <p>Sortie de purge : G 1/8</p> <p>Débit de purge à 7 bar : 560 l/heure</p> <p>Poids du purgeur : 1960 g</p> <p>Pression : 10 bar à 20° C</p> <p>Temperature : 2° à 55° C</p>	PEA 21	
Kit de purge temporisée						
		98	115	43	<p>Kit prêt à monter comprenant:</p> <ul style="list-style-type: none"> - un timer programmable - une électrovanne d'évacuation de condensats 220 V - un collecteur d'impureté avec vanne d'isolement 1/4 de tour - une alimentation électrique complète longueur : 1,20 m - un raccord autobloquant : Ø 8 mm - 30 cm de tube polyuréthane : Ø 8 mm <p>Entrée G 3/8 ou G 1/2 - Sortie G 3/8</p>	TEMP 38220KIT

gamme pvr

SYSTÈME POUR RÉSEAUX D'AIR COMPRIMÉ

SYSTÈME PVR, RACCORDS, TUBES ET ACCESSOIRES

Réalisez facilement vos réseaux d'air comprimé

- ▶ Rapidité et facilité de mise en oeuvre
- ▶ Installation à long terme
- ▶ Matériau inaltérable thermoplastique
- ▶ Compatibilité aux huiles de compresseurs
- ▶ Résistance aux chocs

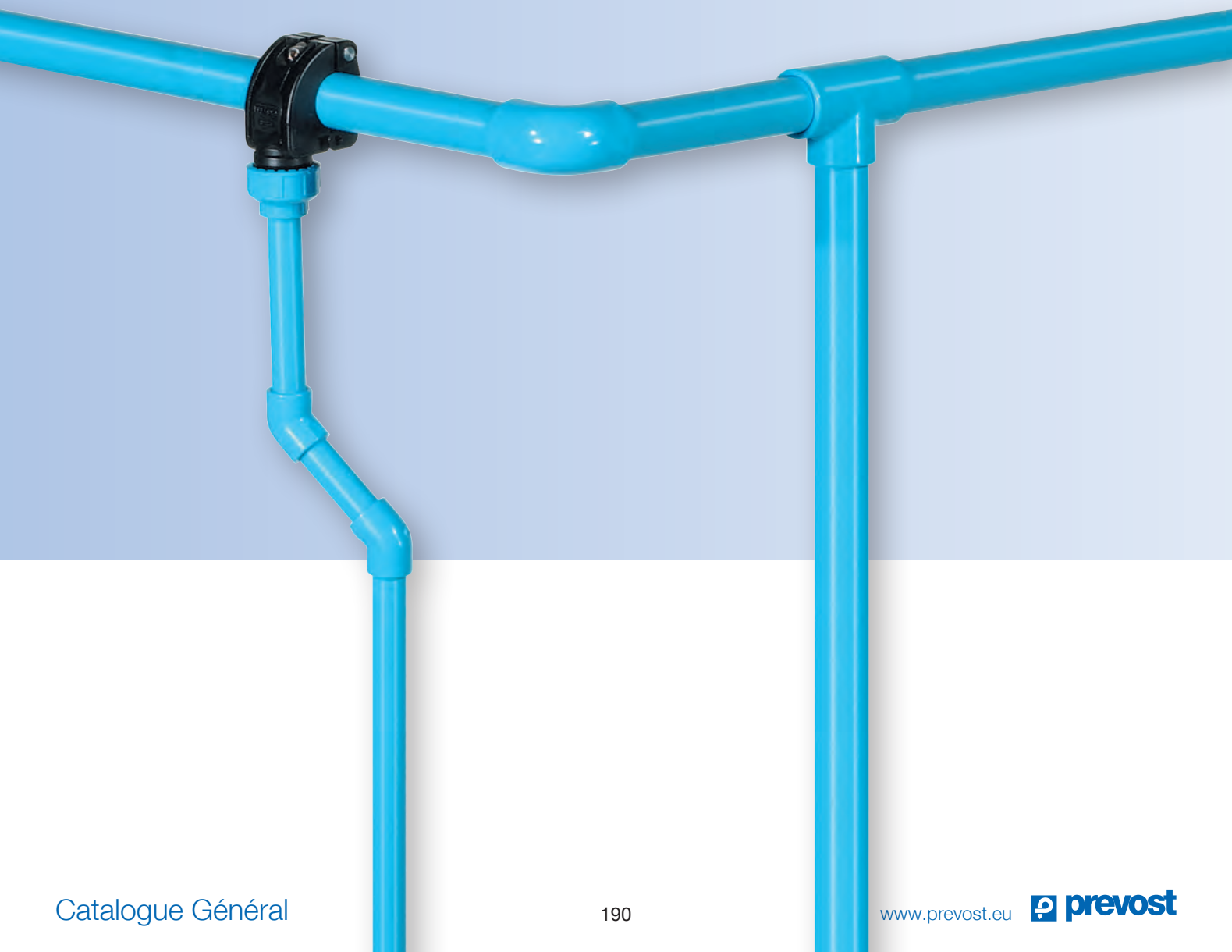

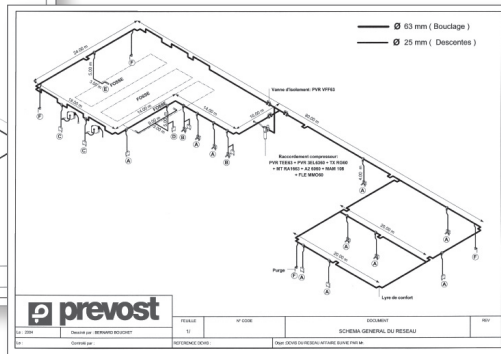
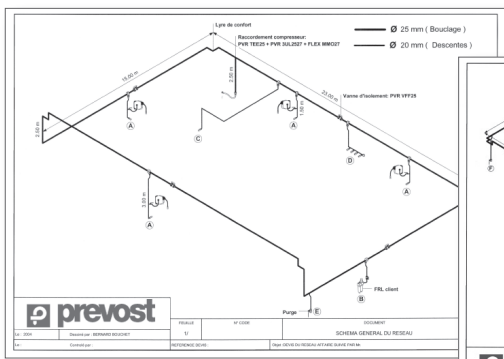

► **PLAN et DEVIS SUR DEMANDE** suivant votre projet d'installation

MATIÈRE

Composition de PVC et de matériaux résilients qui constitue un produit ductile et inaltérable.

FLUIDE TRANSPORTÉ

Air comprimé.

RÉSISTANCE

- Résistance au feu : matériel auto-extinguible qui ne propage pas la flamme
- Résistance aux U.V. : le système PVR ne craint pas la lumière. Toutefois, en cas d'exposition face à une vitre ou à l'extérieur, il est nécessaire de protéger le tube avec un écran anti U.V.
- Résistance aux chocs (selon norme NF EN ISO 180)
- Températures admissibles : -20°C + 50°C

FIABILITÉ

- Matériel inaltérable sans maintenance
- Compatibilité avec les huiles de compresseurs
- Pas de contamination de l'air par la canalisation

INSTALLATION

Montage du réseau par assemblage de tubes et raccords réalisé par soudure à froid.

La variété des raccords et accessoires permet l'adaptation du réseau à la configuration de l'atelier.

Le coût de montage est réduit.

COULEUR

Le système PVR est pigmenté de bleu dans la masse. Couleur conforme à la norme NFX 08-100.

PRESSIION D'UTILISATION

Tube Ø 20 à 80 mm :

- PN 13 bar à 23°C
- PN 7 bar à 50°C

RÈGLES DE BASE D'INSTALLATION D'UN RÉSEAU

- Le réseau principal doit être bouclé et équipé de points fixes et de lyres pour compenser la dilatation.
- La dimension de la canalisation principale sera suffisamment importante pour répondre aux extensions futures et éviter les pertes de charges.
- La canalisation primaire doit être fixée avec une légère pente afin d'évacuer les condensats vers les points bas (purges).
- Mise en pression, test à 10 bar :
 - 10 min après la pose pour Ø de tube 20 à 63 mm,
 - 60 min après la pose pour Ø de tube 80 mm.

Pour une mise en pression définitive suivant les conditions d'installation (température 20° C, humidité ambiante), il est conseillé d'attendre 12 heures.

► **MANUEL TECHNIQUE / NOTICE DE MONTAGE** disponibles sur demande

DÉFINIR LE DIAMÈTRE DU TUBE EN FONCTION DU DÉBIT

DÉFINIR LE DIAMÈTRE DU TUBE EN FONCTION DU DÉBIT

Le calcul du diamètre du tube s'effectue en tenant compte :

- ▶ Du débit souhaité (perte de charge maxi de 5% par rapport à la pression d'entrée)
- ▶ De la longueur de canalisation principale

▶ Le tableau ci-dessous permet de définir le diamètre du tube* en fonction de la longueur du réseau et du débit** à distribuer

Exemple : Longueur canalisation : 280 mètres
Débit : 110 m³/h (1 cv environ = 7 m³/h)
Diamètre de tube préconisé = Ø 40

Longueur	Ø tube						
	Ø 20	Ø 25	Ø 32	Ø 40	Ø 50	Ø 63	Ø 90
50 m	42	83	156	300	540	1075	2900
75 m	33	66	125	240	425	850	2300
100 m	28	56	105	200	360	720	1950
150 m		45	84	160	285	570	1550
200 m		38	71	135	243	480	1320
300 m		30	57	110	192	380	1050
400 m			47	93	162	325	890
500 m			42	81	145	285	775
750 m			34	65	113	225	625
1000 m			28	55	97	195	530

*en mm

** sous 6 bar en m³/h

▶ LYRE POUR COMPENSER LA DILATATION

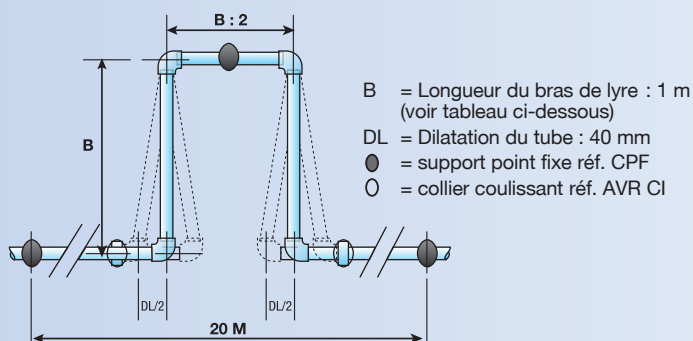

DILATATION EN FONCTION DE LA TEMPÉRATURE

Pour compenser les phénomènes de dilatation ou de contraction dus aux variations de température, le réseau PVR sera équipé de dispositifs d'absorption. Ces dispositifs seront maintenus par des supports coulissants. Le réseau s'allonge quand la température de service augmente et se contracte quand elle diminue.

- ▶ La mesure de ces variations est réalisée à partir du coefficient de dilatation : Coefficient de dilatation : 0,075 mm par mètre et par degré C.

La dilatation se calcule de la manière suivante:

C = coefficient de dilatation

L = longueur de la ligne droite en m (entre 2 points fixes)

ΔT° = différence entre la température de pose et la température de service en $^\circ C$

DL = dilatation globale

Soit : $DL = C \times L \times \Delta T^\circ$

EXEMPLE: une ligne de 20 mètres posée en Ø 50 à une température ambiante de 15 $^\circ C$ pouvant subir une température maxi de 40 $^\circ C$
Soit ΔT° : 25 $^\circ C$ de différence entre pose et service

Soit DL:

$0,075 \times 20 \text{ (m)} \times 25 \text{ (} 40^\circ C - 15^\circ C \text{)} = 37 \text{ mm}$

▶ LONGUEUR D'UN BRAS DE LYRE

Calcul en fonction de la dilatation globale (DL) et du Ø du tube

Dilatation en mm	Tube						
	Ø 20	Ø 25	Ø 32	Ø 40	Ø 50	Ø 63	Ø 90
10 mm	25 cm	30 cm	35 cm	40 cm	45 cm	50 cm	60 cm
20 mm	35 cm	40 cm	45 cm	50 cm	60 cm	65 cm	85 cm
30 mm	45 cm	50 cm	55 cm	70 cm	80 cm	90 cm	125 cm
40 mm	50 cm	60 cm	70 cm	85 cm	100 cm	115 cm	155 cm
50 mm	65 cm	70 cm	85 cm	100 cm	120 cm	140 cm	190 cm
60 mm	70 cm	80 cm	95 cm	115 cm	140 cm	160 cm	-
70 mm	75 cm	90 cm	110 cm	130 cm	160 cm	180 cm	-
80 mm	85 cm	100 cm	125 cm	145 cm	180 cm	200 cm	-

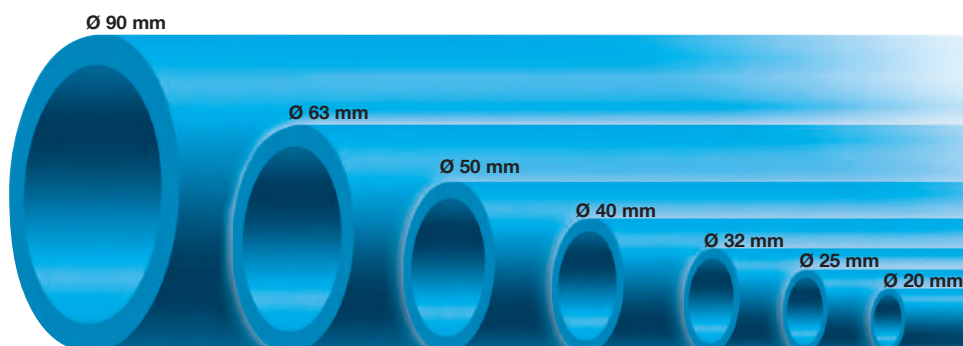

Principe de Montage :



COUPER

La coupe doit être d'équerre. Utilisation d'une scie à métaux et d'une boîte à ongles ou de préférence, un coupe-tube «PVR CTU».

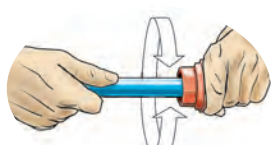

EBARBER CHANFREINER

Après la coupe, ébarber le tube à l'intérieur et, pour une répartition uniforme de la colle, exécuter un chanfrein sur l'extérieur du tube (1/2 épaisseur du tube). Outil à chanfreiner: réf. PVR CHE.



DÉCAPER

Le dégraissage de la surface externe du tube et interne des raccords élimine toutes traces de corps gras. Il assure une soudure parfaite. Décapage au chiffon avec le nettoyant réf. PVR DEC. Pour matérialiser la longueur de tube à décaper puis à encoller, tracer sur le tube la longueur qui sera emboîtée.



ENCOLLER

Utiliser le produit de fusion «PVR COL» T°: + 5 à + 25°C. Appliquer le produit sur la partie du tube à emboîter jusqu'au repère en deux couches minces croisées, la deuxième étant réalisée longitudinalement, puis à l'intérieur du raccord à l'aide du pinceau fourni dans le bouchon.



EMBOÏTER

Immédiatement après l'application de la colle, emboîter les 2 éléments à fond en poussant longitudinalement et sans rotation.

RÉALISATION DE L'INSTALLATION

MISE EN ŒUVRE DES DESCENTES

Bride de dérivation pour obtenir un air moins chargé en eau et condensats

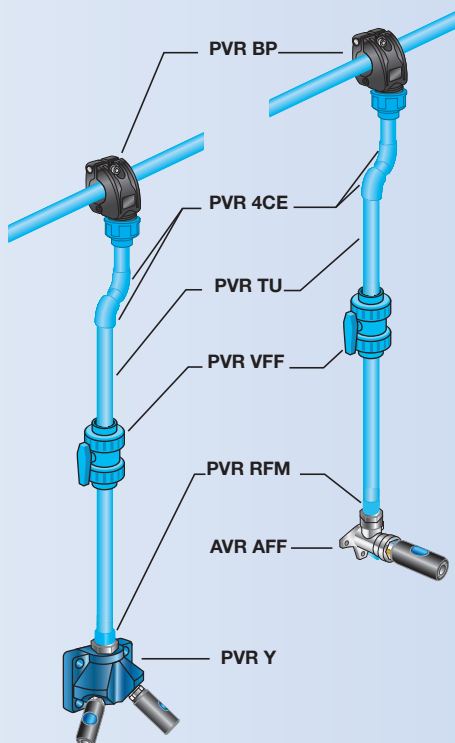

MISE EN PLACE DES ENSEMBLES DE TRAITEMENT D'AIR COMPRIMÉ

Les coudes 45° permettent de compenser le désaxage entre réseau et ensemble de filtration

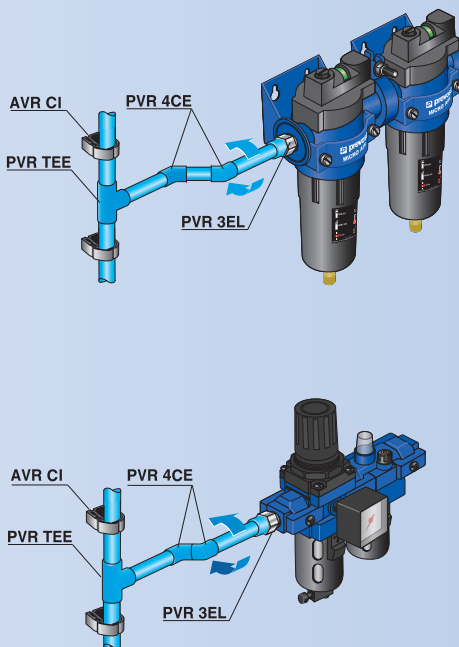

SÉLECTION DES MODES DE FIXATION SELON L'ENVIRONNEMENT



FIXATION MURALE

Pose du tube avec les colliers coulissants M8, ancrés directement sur le mur. A positionner au plus près du raccord (20 cm maxi). Colliers réf. AVRCI Vis réf. PV 80

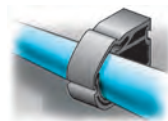

FIXATION AU PLAFOND

Pose du tube avec les colliers coulissants, maintenus par une tige filetée ancrée sur charpente métallique (IPN) par clips adaptés. Clips de fixation suivant épaisseur de charpente: réf. CP 38, réf. CP 1420 ou réf. CP 016 + Tiges filetées M8 réf. TF M8100

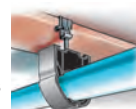

FIXATION SUR CONSOLE

Pose du tube avec les colliers coulissants, fixés sur console métallique pour installer le réseau en évitant les obstacles. Équerre: réf. CS 150L - réf. CS 300L réf. CS 450L - réf. CS 500L réf. CS 180L - réf. CS 310L réf. CS 420L - réf. CS 500L



► SOUDURE A FROID

L'assemblage par soudure à froid réalise une fusion des pièces assemblées.

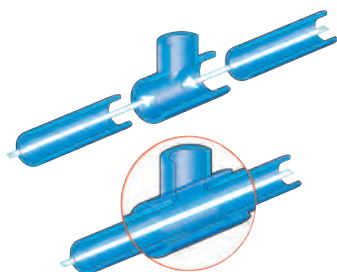

Ø Ext.	Nombre de collages			Nombre de découpes
	Pot 250 ml	Pot 500 ml	Pot 1000 ml	Pot de 500 ml
Ø 20	105	210	425	415
Ø 25	100	200	410	410
Ø 32	80	160	330	330
Ø 40	30	60	125	125
Ø 50	27	54	110	100
Ø 63	25	50	100	90
Ø 90	12	24	60	60

► TEMPS DE SÉCHAGE

Le temps de séchage de la colle est variable en fonction de la température et de l'hygrométrie ambiante.





Pour garantir la tenue des collages lors de la mise sous pression, respecter les temps ci-dessous:

Ø ext. tube ALR	Test à 10 bar	Pression définitive
Ø 20 à 63 mm	10 min	12 heures
Ø 90 mm	60 min	12 heures

CONCEPT PVR

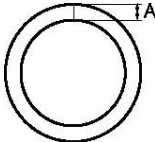

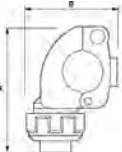

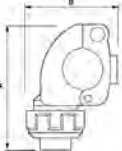

RESEAUX AIR COMPRIME

Anti chocs	Auto extinguible Ne propage pas la flamme	Anti corrosion Inaltérable	Compatible Huiles compresseurs	Etanche test 10 min. après assemblage	Montage Rapide	Matière Composite ductile	Pression 13 bar à 20° C
------------	---	-------------------------------	--------------------------------------	---	-------------------	------------------------------	----------------------------

		A	B	DESIGNATION		REFERENCE
PVR TU - Tube rigide PVC - Longueur des barres : 4 mètres						
				Les Ø 20, 25, 32, 40, 50, 63, sont visés par l'article 3.3 de la directive 97/23/CE; à ce titre, ils ne sont pas marqués du symbole CE. La référence est gérée au mètre. Ø ext.		
		2.2	20			PVR TU20
		2.5	25			PVR TU25
		3.4	32			PVR TU32
		3.8	40			PVR TU40
		5.1	50			PVR TU50
		5.8	63			PVR TU63
		7.8	90			PVR TU90
		PVR BP - Bride de piquage pour tube				
				Canalisation primaire Ø ext.	Descente Ø ext.	
		110	70	25	20 mm	PVR BP2520
		110	70	32	20 mm	PVR BP3220
		121	83	40	20 mm	PVR BP4020
		121	87	40	25 mm	PVR BP4025
		150	105	50	20 mm	PVR BP5020
		150	105	50	25 mm	PVR BP5025
		150	111	63	20 mm	PVR BP6320
		150	111	63	25 mm	PVR BP6325
		150	111	63	32 mm	PVR BP6332
AVR BT - Bride de piquage taraudée						
				Canalisation primaire Ø ext.	Taraudage	
		110	70	25	G 1/2	AVR BT2512
		110	70	32	G 1/2	AVR BT3212
		121	83	40	G 1/2	AVR BT4012
		121	87	40	G 3/4	AVR BT4027
		150	105	50	G 1/2	AVR BT5012
		150	105	50	G 3/4	AVR BT5027
		150	111	63	G 1/2	AVR BT6312
		150	111	63	G 3/4	AVR BT6327
		150	111	63	G 1	AVR BT6334

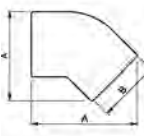
TUBES ET RACCORDS PVR À COLLER

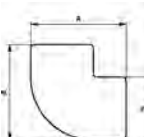
Anti corrosion Inaltérable	Auto extinguable Ne propage pas la flamme	Compatible Huiles compresseurs	Modularité	Montage Rapide	Matière Composite ductile	Étanche Test 10 min. après assemblage	Anti chocs
-------------------------------	---	--------------------------------------	------------	-------------------	------------------------------	---	------------

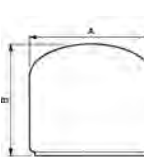
		A	B	C	D	DESIGNATION	REFERENCE
PVR UNI - Union simple femelle							
						Pour tube Ø ext.	
		34	28			20	PVR UNI20
		41	34			25	PVR UNI25
		47	42			32	PVR UNI32
		55	51			40	PVR UNI40
		65	61			50	PVR UNI50
		79	75			63	PVR UNI63
		107	106			90	PVR UNI90
PVR 4CE - Coude égal 45° femelle							
						Pour tube Ø ext.	
		48	28			20	PVR 4CE20
		54	34			25	PVR 4CE25
		65	42			32	PVR 4CE32
		76	51			40	PVR 4CE40
		92	61			50	PVR 4CE50
		114	75			63	PVR 4CE63
		158	105			90	PVR 4CE90
PVR 9CE - Coude égal 90° femelle							
						Pour tube Ø ext.	
		40	26.5			20	PVR 9CE20
		50	32.5			25	PVR 9CE25
		59	41			32	PVR 9CE32
		74	50			40	PVR 9CE40
		88	60			50	PVR 9CE50
		108	75			63	PVR 9CE63
		149	106			90	PVR 9CE90
PVR BOU - Bouchon femelle							
						Pour tube Ø ext.	
		28	27			20	PVR BOU20
		33	31			25	PVR BOU25
		41	36			32	PVR BOU32
		50	43			40	PVR BOU40
		60	49			50	PVR BOU50
		75	57			63	PVR BOU63
		106	80			90	PVR BOU90







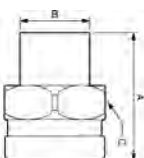

TUBES ET RACCORDS PVR À COLLER

Anti corrosion Inaltérable	Auto extinguable Ne propage pas la flamme	Compatible Huiles compresseurs	Modularité	Montage Rapide	Matière Composite ductile	Étanche Test 10 min. après assemblage	Anti chocs
-------------------------------	---	--------------------------------------	------------	-------------------	------------------------------	---	------------

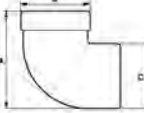
		A	B	C	D	DESIGNATION	REFERENCE		
PVR TEE - Té égal femelle									
						Pour tube Ø ext.			
		54	27.5			20	PVR TEE20		
		66	33.5			25	PVR TEE25		
		78	42			32	PVR TEE32		
		94	51			40	PVR TEE40		
		114	61			50	PVR TEE50		
		142	75			63	PVR TEE63		
		196	106			90	PVR TEE90		
PVR TER - Té réduit femelle/femelle/femelle									
						Pour tube Ø ext.	Pour tube Ø ext.		
		66	27.5	33.5		25	20 mm	PVR TER2520	
		78	27.5	42		32	20 mm	PVR TER3220	
		78	33.5	42		32	25 mm	PVR TER3225	
		94	27.5	51		40	20 mm	PVR TER4020	
		94	33.5	51		40	25 mm	PVR TER4025	
		114	27.5	61		50	20 mm	PVR TER5020	
		114	33.5	61		50	25 mm	PVR TER5025	
		142	27.5	75		63	20 mm	PVR TER6320	
		142	33.5	75		63	25 mm	PVR TER6325	
		196	51	106		90	40 mm	PVR TER9040	
PVR RFT - Raccord droit femelle/taroué									
						Pour tube Ø ext.	Taroudage Gaz BSP		
		35	28	27.5		20	G 1/2	PVR RFT2012	
		42	34	33.5		25	G 3/4	PVR RFT2527	
		48	42	42		32	G 1	PVR RFT3234	
PVR RFM - Raccord droit fileté pour raccord à coller ou pour tube									
						Pour raccord Ø int.	Pour tube Ø ext.	Filetage Gaz BSP	
		43	20	24		20	16	G 1/2	PVR RFM162012
		46	25	27		25	20	G 1/2	PVR RFM202512
		50	32	36		32	25	G 3/4	PVR RFM253227
		57	40	42		40	32	G 1	PVR RFM324034
		67	50	55		50	40	G 1 1/4	PVR RFM405042
		74	63	65		63	50	G 1 1/2	PVR RFM506349
		84	75	75		75	63	G 2	PVR RFM637560

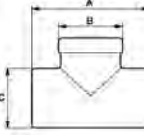

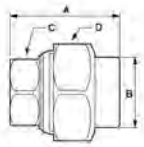
TUBES ET RACCORDS PVR À COLLER

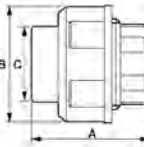
Anti corrosion Inaltérable	Auto extinguable Ne propage pas la flamme	Compatible Huiles compresseurs	Modularité	Montage Rapide	Matière Composite ductile	Étanche Test 10 min. après assemblage	Anti chocs
-------------------------------	---	--------------------------------------	------------	-------------------	------------------------------	---	------------

		A	B	C	D	DESIGNATION	REFERENCE	
PVR RMT - Raccord droit taraudé								
		40.5	20	30		Pour raccord Ø int.	Filetage Gaz BSP	
		45	25	36		20	G 1/2	PVR RMT2012
						25	G 3/4	PVR RMT2527
PVR 9CT - Coude 90° femelle/taraudé								
		41	27.5	26.5		Pour tube Ø ext.	Taraudage Gaz BSP	
		51	33.5	32.5		20	G 1/2	PVR 9CT2012
						25	G 3/4	PVR 9CT2527
PVR TET - Té femelle/femelle/taraudé								
		54	27.5	28.5		Pour tube Ø ext.	Taraudage Gaz BSP	
		66	33.5	34.5		20	G 1/2	PVR TET2012
		78	42	43		25	G 3/4	PVR TET2527
					32	G 1	PVR TET3234	
PVR 3UL - Union 3 pièces laiton femelle/taraudée								
		43	29	25	44	Pour tube Ø ext.	Taraudage Gaz BSP	
		49.5	34	32	47	20	G 1/2	PVR 3UL2012
		53	41.5	38	55	25	G 3/4	PVR 3UL2527
		61	51.5	47	65	32	G 1	PVR 3UL3234
		69	59	54	72	40	G 1 1/4	PVR 3UL4042
		79	67	61	79	50	G 1 1/2	PVR 3UL5049
		88	74	67	89	63	G 2	PVR 3UL6360
PVR 3UN - Union 3 pièces femelle/femelle								
		45	27.5	27.5		Pour tube Ø ext.		
		51	34	34.5		20		PVR 3UN20
		57	41	41.5		25		PVR 3UN25
		67	51	51.5		32		PVR 3UN32
		79	59	59		40		PVR 3UN40
		88	67	67		50		PVR 3UN50
		98	74	74		63		PVR 3UN63

TUBES ET RACCORDS PVR À COLLER

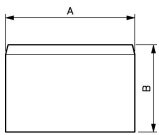

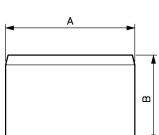

Anti corrosion Inaltérable	Auto extinguable Ne propage pas la flamme	Compatible Huiles compresseurs	Modularité	Montage Rapide	Matière Composite ductile	Étanche Test 10 min. après assemblage	Anti chocs
-------------------------------	---	--------------------------------------	------------	-------------------	------------------------------	---	------------

		A	B	C	D	DESIGNATION		REFERENCE
PVR RDS - Réduction simple								
						Pour raccord Ø int.	Pour tube Ø ext.	
		25	19			25	20	PVR RDS2520
		32	22			32	25	PVR RDS3225
		40	26			40	32	PVR RDS4032
		50	31			50	40	PVR RDS5040
63	38			63	50	PVR RDS6350		
PVR RDD - Réduction double								
						Pour raccord Ø int.	Pour tube Ø ext.	
		32	22			32	20	PVR RDD3220
		32	22			40	25	PVR RDD4025
		40	26			50	32	PVR RDD5032
		50	31			63	40	PVR RDD6340
90	51			90	63	PVR RDD9063		

APPLIQUES MURALES PREVO S1

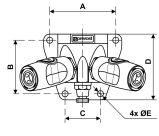
NOUVEAU

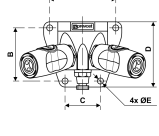
Pression PN 12 bar	Matière applique : alliage d'aluminium	Sécurité anti-coup de fouet	Montage mural - 4 trous de fixation	Purge manuelle intégrée	Possibilité d'orientation des boutons
-----------------------	--	--------------------------------	--	----------------------------	--

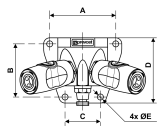







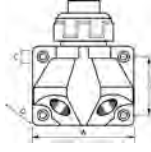

		A	B	C	D	E	DESIGNATION		REFERENCE
Applique murale taraudée - 2 raccords et purge manuelle - Profil ISO B - Passage 6 mm									
							Entrée taraudée	Sortie : 2 raccords	
		71	57	38	70	6,5	G 1/2	2 raccords ISI 06	ISI 068103WF
		71	57	38	70	6,5	G 3/4	2 raccords ISI 06	ISI 068104WF
Applique murale taraudée - 2 raccords et purge manuelle - Profil ISO B - Passage 8 mm									
							Entrée taraudée	Sortie : 2 raccords	
		71	57	38	70	6,5	G 1/2	2 raccords ISI 08	ISI 088103WF
		71	57	38	70	6,5	G 3/4	2 raccords ISI 08	ISI 088104WF
Applique murale taraudée - 2 raccords et purge manuelle - Profil Européen 7.2 mm									
							Entrée taraudée	Sortie : 2 raccords	
		71	57	38	70	6,5	G 1/2	2 raccords ESI 07	ESI 078103WF
		71	57	38	70	6,5	G 3/4	2 raccords ESI 07	ESI 078104WF

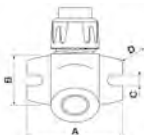
APPLIQUES MURALES PREVO S1

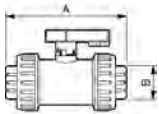
NOUVEAU

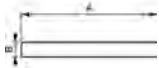

Pression PN 12 bar	Matière applique : alliage d'aluminium	Sécurité anti-coup de fouet	Montage mural - 4 trous de fixation					Purge manuelle intégrée	Possibilité d'orientation des boutons
		A	B	C	D	E	DESIGNATION		REFERENCE
Applique murale taraudée - 2 raccords et purge manuelle - Profil ISO C - Passage 6 mm									
		71	57	38	70	6,5	Entrée taraudée G 1/2	Sortie : 2 raccords 2 raccords CSI 06	CSI 068103WF
		71	57	38	70	6,5	G 3/4	2 raccords CSI 06	CSI 068104WF
Applique murale taraudée - 2 raccords et purge manuelle - Profil ISO C - Passage 8 mm									
		71	57	38	70	6,5	Entrée taraudée G 1/2	Sortie : 2 raccords 2 raccords CSI 08	CSI 088103WF
		71	57	38	70	6,5	G 3/4	2 raccords CSI 08	CSI 088104WF
Applique murale taraudée - 2 raccords et purge manuelle - Profil ARO - Passage 6 mm									
		71	57	38	70	6,5	Entrée taraudée G 1/2	Sortie : 2 raccords 2 raccords ASI 06	ASI 068103WF
		71	57	38	70	6,5	G 3/4	2 raccords ASI 06	ASI 068104WF
Applique murale taraudée - 2 raccords et purge manuelle - Profil British - Passage 6 mm									
		71	57	38	70	6,5	Entrée taraudée G 1/2	Sortie : 2 raccords 2 raccords BSI 06	BSI 068103WF
		71	57	38	70	6,5	G 3/4	2 raccords BSI 06	BSI 068104WF
Applique murale taraudée - 2 raccords et purge manuelle - Profil Truflate - Passage 6 mm									
		71	57	38	70	6,5	Entrée taraudée 1/2 NPT	Sortie : 2 raccords 2 raccords USI 06	USI 068203WF
		71	57	38	70	6,5	3/4 NPT	2 raccords USI 06	USI 068204WF
Applique murale taraudée - 2 raccords et purge manuelle - Profil Truflate - Passage 8 mm									
		71	57	38	70	6,5	Entrée taraudée 1/2 NPT	Sortie : 2 raccords 2 raccords USI 08	USI 088203WF
							3/4 NPT	2 raccords USI 08	USI 088204WF

ACCESSOIRES POUR RESEAUX PVR

Anti corrosion Inaltérable	Auto extinguable Ne propage pas la flamme	Compatible Huiles compresseurs	Modularité				Montage Rapide	Matière Composite ductile	Etanche Test 10 min. après assemblage	Anti chocs
PVR Y - Applique murale double taraudée		A	B	C	D	DESIGNATION		REFERENCE		
		100	52	7	79	1 entrée pour tube	2 sorties	PVR Y20		
		100	52	7	79	Ø 20	G 1/2	PVR Y25		
		100	52	7	79	Ø 20	G 1/2 avec purge man.	PVR YP20		
		100	52	7	79	Ø 25	G 1/2 avec purge man.	PVR YP25		
PVR M - Applique murale 1 entrée pour tube et 1 sortie taraudée		A	B	C	D	1 entrée pour tube	Sortie 1 raccord			
		81	45	8	77	Ø 20	G 1/2	PVR M2012		
		81	45	8	77	Ø 25	G 1/2	PVR M2512		
PVR VFF - Vanne à boiseau sphérique femelle pour tube		A	B							
		80	73			20		PVR VFF20		
		91	84			25		PVR VFF25		
		102	96			32		PVR VFF32		
		120	115			40		PVR VFF40		
		144	135			50		PVR VFF50		
		172	160			63		PVR VFF63		
PVR COB - Collet strié sans joint		A	B							
		125	108			90		PVR COB90		
PVR BRI - Bride pour collet		A	B							
		200	20			90		PVR BRI90		
PVR JNT - Joint pour bride										
						Pour tube Ø ext.				
						90		PVR JNT90		
PVR DEC - Décapant pour tube PVR										
						Dégraissant / nettoyant conditionnement : 500 ml		PVR DEC500		





ACCESSOIRES POUR RESEAUX PVR

Anti corrosion Inaltérable	Auto extinguable Ne propage pas la flamme	Compatible Huiles compresseurs	Modularité	Montage Rapide	Matière Composite ductile	Etanche Test 10 min. après assemblage	Anti chocs
-------------------------------	---	--------------------------------------	------------	-------------------	------------------------------	---	------------

		A	B	C	D	DESIGNATION	REFERENCE
PVR COL - Soudure à froid et pinceau pour tube PVR							
						Soudure à froid pour assemblage raccords/tubes avec pinceau intégré dans le couvercle Conditionnement:	
						250 ml	PVR COL250
						500 ml	PVR COL500
						1000 ml	PVR COL1000
PVR KITM - Kit d'assemblage pour tube PVR							
						Comprenant :	
						1 Cône à chanfreiner pour tubes Ø ext : 20 à 50 1 Décapant - 500 ml 1 Soudure à froid - 500 ml	PVR KITM

ACCESSOIRES POUR RESEAUX ALR ET PVR

Compatible Huiles compresseurs	Pression PN 13 bar à 40°C	Anti chocs	Montage Facile
-----------------------------------	------------------------------	------------	-------------------

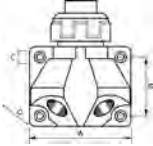
		A	B	C	D	DESIGNATION	REFERENCE
AVR AFF - Applique murale taraudée/taraudée							
		50	41			Laiton nickelé Entrée taraudée Sortie taraudée G 1/2 G 1/2	AVR AFF12
AVR AFM - Applique murale filetée/taraudée							
		48.5	41			Laiton nickelé Entrée filetée Sortie taraudée G 1/2 G 1/2	AVR AFM12
		60	47			G 3/4 G 3/4	AVR AFM27
AVR Y - Applique murale double taraudée/taraudée							
		100	52	7	79	Taraudage 1 entrée Taraudage 2 sorties G 1/2 G 1/2	AVR Y1212
		100	52	7	79	G 3/4 G 1/2	AVR Y2712
		100	52	7	79	G 1/2 G 1/2 avec purge man.	AVR Y1212P
		100	52	7	79	G 3/4 G 1/2 avec purge man.	AVR Y2712P

ACCESSOIRES POUR RESEAUX ALR ET PVR





Compatible Huiles compresseurs	Pression PN 13 bar à 40°C	Anti chocs	Montage Facile
-----------------------------------	------------------------------	------------	-------------------

		A	B	C	D	DESIGNATION		REFERENCE
AVR M - Applique murale simple taraudée/taraudée								
		81	45	8	77	Taraudage 1 entrée	Taraudage 1 sortie	AVR M1212
						G 1/2	G 1/2	
AVR CI - Collier de fixation								
						- Tête hexagonale de Ø 8 mm à l'intérieur du collier - Livré avec un écrou M8 pour la fixation du collier sur tige filetée ou maintien de la tête de la vis VBA		
		50	31			20		AVR CI20
		54	39			25		AVR CI25
		59	49			32		AVR CI32
		100	61			40		AVR CI40
		107	76			50		AVR CI50
		114	93			63		AVR CI63
		155	119			80		AVR CI80
Colliers pour point fixe taraudé M8								
		64	51			20		CPF 20
		70	52			25		CPF 25
		78	60			32		CPF 32
		91	67			40		CPF 40
		100	73			50		CPF 50
		102	83			63		CPF 63
		124	116			80		CPF 80
Console métallique de support								
		180				Longueur	Poids max. réparti sur la longueur	
		420				180 mm	133 kg (1)	CS 180L
		510				420 mm	56,4 kg (1)	CS 420L
		-	-			510 mm	75 kg (2)	CS 500
		-	-			Vis de fixation M8 (3) sur console CS 500		CS VIS
		-	-			Vis de fixation (4) pour consoles CS 180L - CS 310L - CS 420L		CS VIS2
						300 mm	80 kg (1)	CS 310L
Clips de fixation taraudé M8								
		47	45			3 à 8 mm (1)		CP 38
		53	45			8 à 14 mm (1)		CP 814
		58	45			14 à 20 mm (1)		CP 1420
		30	34			0 à 16 mm M6 ou traversant (2)		CP 016

ACCESSOIRES POUR RESEAUX ALR ET PVR

Compatible Huiles compresseurs		Pression PN 13 bar à 40°C				Anti chocs	Montage Facile
		A	B	C	D	DESIGNATION	REFERENCE
Vis VBA Ø 6 mm							
		60				Longueur 60 mm	TVB 660
		90				Longueur 90 mm	TVB 690
Vis fileté Ø 8 mm							
		60				Longueur 60 mm	TVM 860
Tire-fond Ø 8 mm							
		50				Longueur 50 mm	TTF 850
		80				Longueur 80 mm	TTF 880
Goujon galvanisé fileté M8							
		50				Pour tous types de matériaux Longueur 50 mm	PV 80
		80				Longueur 80 mm	PV 880
Tige de liaison							
		77				M8	TL M8
Tige fileté							
		100				Longueur : 1m - M8	TF M8100
		30				Union pour tige fileté M8	TL RM8
		-				Ecrou M8	TE M8
Scie cloche pour perçage tubes ALR et PVR							
						Outil de perçage pour pose de brides de piquage	
						Perçage pour piquage Ø de perçage	
						Tubes Ø 25 et Ø 32 mm 14 mm	AVR SP14
					Tubes Ø 40 à 80 17 mm	AVR SP17	

ACCESSOIRES POUR RESEAUX ALR ET PVR









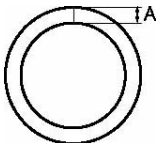

Compatible Huiles compresseurs		Pression PN 13 bar à 40°C				Anti chocs	Montage Facile
		A	B	C	D	DESIGNATION	REFERENCE
Coupe tube							
						Pour tube Ø ext.	
						1 - 20 à 40 - Coupe tube pour tube PVR	PVR CTU40
						2 - 50 à 110 - Coupe tube pour tube PVR	PVR CTU110
						2 - 20 à 63 - Coupe tube pour tube ALR	ALR CTU63
AVR CHE - Outil pour chanfreiner (chanfrein 15°)							
						Pour tube Ø ext.	
						1 - 20 à 50 mm	AVR CHE50
						2 - 20 à 50 mm	AVR CHE50P
						3 - Ebavurage int./ ext.	AVR CHERAP
						4 - 20 à 110 mm	PVR CHE110
ALR CTCHE - Outil pour couper et chanfreiner les tubes							
						Pour tube Ø ext.	
						63 et 80	ALR CTCHE6380
Ebavureur pour perceuse							
						Fourni avec un adaptateur pour mandrin d'outils à entraînement	
						Pour tube Ø ext. 10 à 40 mm	AVR EBA

Matière Caoutchouc synthétique, tresse acier	Norme ISO 4413 - 1998	Application raccordement Raccords tournants	Résistance Huiles, abrasion, ozone
---	--------------------------	--	---------------------------------------

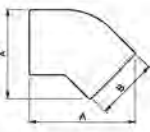
		Longueur m.	Température °C	Pression maxi. de service (bar)	Filetage Gaz BSP	Rayon de courbure à 20°C (mm)	REFERENCE
Flexibles de compensation des dilations et contractions des réseaux d'air - Raccordements mâles tournants							
	NOUVEAU	0.75	-40° +70° C	105	R 3/4	240	LAM 27
		0.75	-40° +70° C	88	R 1	300	LAM 34
		1.1	-40° +70° C	63	R 1 1/4	420	LAM 42
		1.25	-40° +70° C	50	R 1 1/2	500	LAM 49
		1	-40° +70° C	40	R 2	630	LAM 60
Flexible de liaison - Raccordements femelles tournants							
	NOUVEAU	1.5	-40° +110° C	180	G 3/8	130	LEF 17
		1.5	-40° +110° C	160	G 1/2	130	LEF 21
		1.5	-40° +110° C	105	G 3/4	240	LEF 27
		1.5	-40° +110° C	88	G 1	300	LEF 34
		2.2	-40° +110° C	63	G 1 1/4	420	LEF 42
		2.5	-40° +110° C	50	G 1 1/2	500	LEF 49
		2	-40° +110° C	80	G 2	630	LEF 60
Flexibles de liaison avec câble acier de sécurité - Raccordements femelles tournants							
	NOUVEAU	1.5	-40° + 110°C	180	G 3/8	130	LEF 17S
		1.5	-40° +110° C	160	G 1/2	130	LEF 21S
		1.5	-40° +110° C	105	G 3/4	240	LEF 27S
		1.5	-40° +110° C	88	G 1	300	LEF 34S
Flexibles de liaison - Raccordement mâles tournants							
	NOUVEAU	1.5	-40° +110° C	180	R 3/8	130	LEM 17
		1.5	-40° +110° C	160	R 1/2	180	LEM 21
		1.5	-40° +110° C	105	R 3/4	240	LEM 27
		1.5	-40° +110° C	80	R 1	300	LEM 34
		2.2	-40° +110° C	63	R 1 1/4	420	LEM 42
		2.5	-40° +110° C	50	R 1 1/2	500	LEM 49
		2	-40° +110° C	80	R 2	630	LEM 60
Flexibles de liaison avec câble de sécurité - Raccordements mâles tournants							
	NOUVEAU	1.5	-40° +110° C	180	R 3/8	130	LEM 17S
		1.5	-40° +110° C	160	R 1/2	180	LEM 21S
		1.5	-40° +110° C	105	R 3/4	240	LEM 27S
		1.5	-40° +110° C	88	R 3/4	300	LEM 34S

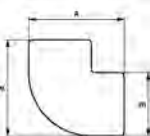

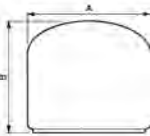

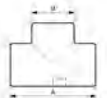



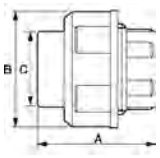

CONCEPT PNE POUR RESEAU AZOTE

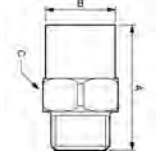
Anti corrosion Inaltérable	Auto extinguable Ne propage pas la flamme	Compatible Huiles compresseurs	Modularité	Montage Rapide	Matière Composite ductile	Etanche Test 10 min. après assemblage	Anti chocs
-------------------------------	---	--------------------------------------	------------	-------------------	------------------------------	---	------------

		A	B	C	DESIGNATION	REFERENCE
PNE TU - Tube rigide PVC - Longueur des barres : 4 mètres						
		3.8			Le Ø 32 est visé par l'article 3.3 de la directive 97/23/CE; à ce titre, il n'est pas marqué du symbole CE. La référence est gérée au mètre. Ø ext. Ø 32 mm	PNE TU32
PNE UNI - Union simple femelle						
		47	42		Pour tube Ø ext. Ø 32 mm	PNE UNI32
PNE 4CE - Coude égal 45° femelle						
		65	42		Pour tube Ø ext. Ø 32 mm	PNE 4CE32
PNE 9CE - Coude égal 90° femelle						
		59	41		Pour tube Ø ext. Ø 32 mm	PNE 9CE32
PNE BOU - Bouchon femelle						
		41	36		Pour tube Ø ext. Ø 32 mm	PNE BOU32
PNE TEE - Té égal femelle						
		78	42		Pour tube Ø ext. Ø 32 mm	PNE TEE32

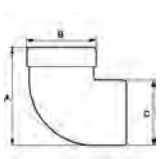
CONCEPT PNE POUR RESEAU AZOTE

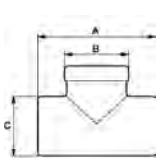
Anti corrosion Inaltérable	Auto extinguable Ne propage pas la flamme	Compatible Huiles compresseurs	Modularité	Montage Rapide	Matière Composite ductile	Étanche Test 10 min. après assemblage	Anti chocs
-------------------------------	---	--------------------------------------	------------	-------------------	------------------------------	---	------------

		A	B	C	DESIGNATION	REFERENCE	
PNE 3UN - Union 3 pièces femelle/femelle							
		57	41	41.5	Pour tube Ø ext. Ø 32 mm	PNE 3UN32	
PNE RFM - Raccord droit fileté							
		57	40	42	Pour tube Ø ext. Ø 32 mm	Filetage Gaz BSP G 1	PNE RFM324034
		60	40	46	Ø 32 mm	G 1 1/4	PNE RFM324042
PNE RFT - Raccord droit femelle/taraudée							
		48	42	42	Pour tube Ø ext. Ø 32 mm	Taraudage Gaz BSP G 1	PNE RFT3234
PNE 9CT - Coude 90° femelle/taraudé							
		60	42	41	Pour tube Ø ext. Ø 32 mm	Taraudage Gaz BSP G 1	PNE 9CT3234
PNE TET - Té femelle/femelle/taraudé							
		78	42	43	Pour tube Ø ext. Ø 32 mm	Taraudage Gaz BSP G 1	PNE TET3234
Pistolet de gonflage							
					Pistolet de gonflage à poignée. Auto, Moto, PL. Tuyau gainé vert dédié azote pour identification Taraudage : G 1/4	PNE 27101	

soupapes

SOUPAPES DE SÉCURITÉ TARÉES

PROTECTION DE VOS APPAREILS

Fonctionnement automatique

En cas de surpression, le siège de soupape se soulève, ce qui ouvre l'orifice d'échappement et permet l'évacuation dans l'atmosphère.

Elle se referme lorsque les conditions de pression sont à nouveau normales.

Dispositif de sécurité

Les soupapes assurent la sécurité du matériel et des opérateurs contre les surpressions éventuelles du circuit. Technologiquement éprouvées et parfaitement étanches, elles constituent une garantie contre les phénomènes dangereux liés au débit ou à la pression. Molette de test manuel de fonctionnement.

Conformité

Livrée scellée au tarage souhaité avec capsule d'invulnérabilité.

Fournie avec une déclaration de conformité, les spécifications de tarage, une notice de montage et d'entretien.

Agréments TÜV et I.S.P.E.L.

Homologation CE 0044 catégorie IV

Numéro de fabrication gravé sur le corps de soupape.



Exemple de débit (Nm³/h)
en fonction de la pression (bar)

	G 1/4	G 3/8	G 1/2	G 3/4	G 1
Réf	A23 14T	A23 38T	A23 12T	A23 34T	A23 01T
Pression					
3	88	177	214	30	610
6	155	313	379	530	1079
7	178	358	434	607	1235
8	200	404	489	694	1392
9	223	449	544	761	1548
10	146	495	599	838	1708
12	392	586	708	991	2022
15	360	724	873	1222	2497
16	382	770	928	1299	2654
20		955	1148	1606	3291
25		1183	1422	1990	
30		1411	1697	2374	

soupapes

SOUPAPES DE SÉCURITÉ À ÉCHAPPEMENT RAPIDE

DÉSIGNATION		RÉFÉRENCE
Soupapes conformes à la directive 97/23/CE homologuées, tarées et scellées.		
Filetage Gaz BSP	Plages de tarage 0,5 en 0,5 bar	
G 1/4		
	0,5 à 12 12,5 à 20 20,5 à 30	A23 14T... A23 14T... A23 14T...
G 3/8		
	0,5 à 12 12,5 à 20 20,5 à 30	A23 38T... A23 38T... A23 38T...
G 1/2		
	0,5 à 12 12,5 à 20 20,5 à 30	A23 12T... A23 12T... A23 12T...
G 3/4		
	0,5 à 12 12,5 à 20 20,5 à 30	A23 34T... A23 34T... A23 34T...
G 1		
	0,5 à 12 12,5 à 20 20,5 à 21	A23 01T... A23 01T... A23 01T...

A la commande : spécifier **impérativement** pour chaque soupape commandée sa référence et la pression de tarage souhaitée en bar.

Exemple :
 Soupape G 1/4
 Pression : 6,5 bar
 Référence : A23 14T6,5

enrouleurs

ENROULEURS AUTOMATIQUES POUR TUYAUX

ALIMENTATION DES OUTILS AUX POSTES DE TRAVAIL

L'enrouleur automatique de tuyau constitue l'équipement de base des ateliers. Il offre gain de temps, sécurité et confort dans l'utilisation des tuyaux souples de distribution.

La gamme est déclinée pour les fluides suivants :

- ▶ Air comprimé
- ▶ Eau froide, eau chaude, haute pression et basse pression
- ▶ Huile, graisse
- ▶ Oxygène et acétylène et pour l'alimentation électrique.



Chaque enrouleur est équipé d'un raccord rapide pour assurer la connexion et le changement d'outil rapide et sans risque.

En fonction du type d'enrouleur et de son usage le plus courant, le raccord rapide de sortie est métallique, polymère, standard ou sécurité.

EFFICACITÉ AUX POSTES DE TRAVAIL

Au moment voulu, l'opérateur déroule la longueur optimale de flexible nécessaire à son travail. Il bloque le tuyau à cette longueur (un léger à coup sur le tuyau place le cliquet d'arrêt).

Il travaille ainsi sans être gêné par le poids du tuyau et son encombrement.

Après relâche du cliquet par une légère tension de l'opérateur sur le tuyau, l'enroulement est automatique.

FACILITÉ D'INSTALLATION ET DE FONCTIONNEMENT

Fixé au mur, au plafond ou sur chariot, équipé d'un support fixe ou pivotant à 180°, l'enrouleur s'adapte à la configuration de l'atelier et à un large champ d'action.

Le branchement sur l'installation est simple grâce à un mètre de tuyau d'alimentation et un raccord tournant à 360° sur le carter (raccord fixe sur modèle DRF).

La connexion de l'outil est facile et sûre, chaque enrouleur étant équipé d'un raccord rapide en sortie de tuyau.

En position repos, une butée de fin de course permet de définir la longueur de tuyau devant rester à l'extérieur de l'enrouleur.

SÉCURITÉ D'UTILISATION

Le rangement automatique du tuyau après usage préserve contre tous risques d'accident :

- rupture du tuyau par un objet tranchant
- enroulements inopinés du tuyau autour d'un élément de l'atelier
- risques de chutes dues aux tuyaux posés au sol.

PROTECTION DES TUYAUX

► Rangement facile et rapide du tuyau dans l'enrouleur par système de ressort de rappel.

► Protection du tuyau enroulé sur le tambour : le tuyau ne traîne pas au sol, il est protégé des polluants, de l'abrasion et des écrasements. Il gagne en longévité.

► Au niveau du raccord de sortie, le tuyau est équipé d'un protecteur anti-torsion qui empêche la "cassure" du tuyau lors des manipulations. Ce protecteur est en polyamide, il est léger et prévient les risques de dommages en cas de chocs.



ENROULEURS à STRUCTURE **ACIER**

Ces enrouleurs à usage professionnel conviennent à toutes les applications industrielles, automobiles, agricoles, en alimentation d'outils pneumatiques, nettoyage, soufflage (suivant les modèles).

La structure en acier est emboutie et galvanisée à chaud puis vernie avec une poudre de polyester résistant aux rayons UV.

Les composants intérieurs de l'enrouleur et ceux en contact avec le fluide sont spécialement traités pour améliorer leur résistance à la corrosion.

En fonction du type de tuyau dont ils sont équipés, les enrouleurs de la gamme acier sont utilisés pour :

- l'air comprimé
- l'eau, l'eau chaude, haute et basse pression,
- la graisse et l'huile
- l'oxygène et l'acétylène



ENROULEURS à STRUCTURE **ACIER INOX**

Leur structure en acier inoxydable AISI 304 permet l'usage de ces enrouleurs dans tous les environnements et particulièrement ceux nécessitant une forte résistance à la corrosion : industrie agro-alimentaire, abattoirs, collectivités, piscines ...

En fonction du type de tuyau dont ils sont équipés, les enrouleurs de la gamme acier INOX sont utilisés pour la distribution de :

- l'air comprimé
- l'eau, l'eau chaude, haute et basse pression



ENROULEURS à **TAMBOUR FERMÉ**



AIR COMPRIMÉ							ÉLECTRICITÉ
	DSF	DMF	DRF	DPF	DGF	DLS	DEL
Type de carter	Acier	Acier	Acier	Acier	Acier	Polyamide	ABS
Type de tuyau	PU	PU	PU/PVC	PU	Caoutchouc	PVC	Câble PVC Câble caoutchouc
Support	Pivotant						
Arrivée d'air	1 m de tuyau d'alimentation						Boîtier électrique
Version INOX	DSF IN		DRF IN				
Ø tuyau (mm)	8 x 11 10 x 14	8 x 12 10 x 14	8 x 12 10 x 14	8 x 12 10 x 14	8 x 14 10 x 17 13 x 20	13 x 20	3 x 1,5 mm ² 3 x 2,5 mm ² 2 x 1 mm ²
Longueur du tuyau (m)	3 m 5 m	10 m	10 m 12 m 15 m	10 m 12 m	10 m 15 m 20 m	20 m	14 m 17 m







ENROULEURS à **TAMBOUR OUVERT**

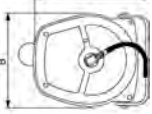

AIR COMPRIMÉ/EAU/GRAISSE/HUILE/OXYGÈNE/ACÉTYLÈNE					
	DMO	DVO	DGO	DLO	DMP
Type de tuyau	Caoutchouc	PU	Caoutchouc	Caoutchouc	PU
Support	Fixe <i>Support orientable disponible en option</i>				Portable
Arrivée d'air	1 m de tuyau d'alimentation				Embout IRP 06
Version Eau Basse pression	Acier Inox	DMO LS DMOI LS		DGO LS DGOI LS	DLO LS DLOI LS
Version Eau Haute pression	Acier Inox	DMO HP DMO HPI		DGO HP DGO HPI	
Version Huile		DMO OIL		DGO OIL	
Version Graisse		DMO GR		DGO GR	
Version Oxygène/Acétyleène		DGO OA			
Ø tuyau (mm)	8 x 14 10 x 17 13 x 20	10 x 14	10 x 17 13 x 20 16 x 23	13 x 20 16 x 23 19 x 27	8 x 12 10 x 14
Longueur du tuyau (m)	10 m 15 m 20 m	25 m	10 m 20 m 25 m	20 m 25 m 30 m	25 m 30 m

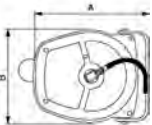

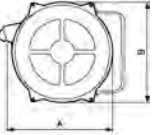

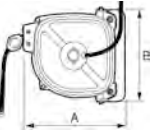



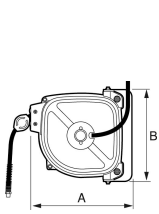

ENROULEURS AIR COMPRIME A TAMBOUR FERME

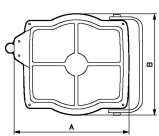
Pression PN. 12 bar	Température 70°C	Matière Acier avec revêtement époxy et acier inox	Anti chocs	Ergonomie du poste de travail	Sécurité d'utilisation	Blocage du tuyau par cliquet d'arrêt
------------------------	---------------------	---	------------	----------------------------------	---------------------------	--

		A	B	Débit Sans raccord l/min	Diamètre int./ext en mm	Equipé d'un raccord rapide	Longueur m	Poids kg	Support intégré	Entrée tournante	Sortie	REFERENCE
Série DSF - Petit modèle - Tuyau polyuréthane												
		260	218	650	8 x 11	ISI 06	5	3	Pivotant	8 x 11		DSF 0805IS
		260	218	1100	10 x 14	ISI 06	3	3	Pivotant	10 x 14		DSF 1003IS
		260	218	650	8 x 11	CSM 06	5	3	Pivotant	8 x 11		DSF 0805CSM
Série DSF - Modèle INOX - Tuyau polyuréthane tressé - Air comprimé												
		260	218	650	8 x 12	ESI 07HE	5	3	Pivotant	8 x 12		DSFI 0805ESHE
Série DMF - Modèle industriel - Tuyau polyuréthane												
		360	275	500	8 x 12	ISI 06	10	8	Pivotant	8 x 12		DMF 0810IS
		360	275	500	8 x 12	CSM 06	10	8	Tournant	8 x 12		DMF 0810CSM
Série DRF - Modèle Eco - Tuyau PU/PVC												
		340	302	500	8 x 12	ISI 06	12	5,8	Pivotant	Fixe 8x12		DRF 0812IS
		370	337	350	8 x 12	ISI 06	15	7,1	Pivotant	Fixe 8x12		DRF 0815IS
		340	302	900	10 x 14	ISI 06	10	5,7	Pivotant	Fixe 10x14		DRF 1010IS
		370	337	800	10 x 14	ISI 06	12	7	Pivotant	Fixe 10x14		DRF 1012IS
		340	302	500	8 x 12	CSM 06	12	5,8	Pivotant	Fixe 8x12		DRF 0812CSM
		370	337	350	8 x 12	CSM 06	15	7,1	Pivotant	Fixe 8x12		DRF 0815CSM
		340	302	900	10 x 14	CSM 06	10	5,7	Pivotant	Fixe 10x14		DRF 1010CSM

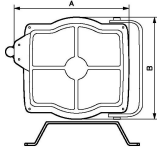
ENROULEURS AIR COMPRIME A TAMBOUR FERME

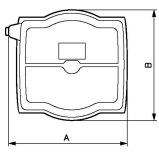
Pression PN. 12 bar	Température 70°C	Matière Acier avec revêtement époxy et acier inox	Anti chocs	Ergonomie du poste de travail	Sécurité d'utilisation	Blocage du tuyau par cliquet d'arrêt
------------------------	---------------------	---	------------	----------------------------------	---------------------------	--

		A	B	Débit Sans raccord l/min	Diamètre int./ext en mm	Equipé d'un raccord rapide	Longueur m	Poids kg	Support intégré	Entrée tournante	Sortie	REFERENCE	
Série DRF - Modèle INOX - Tuyau polyuréthane - Air comprimé													
				Support orientable à 180°									
		370	337	800	10 x 14	ESI 07HE	12	6,3	Pivotant	Fixe 10x14		DRFI 1012ESHE	
Série DPF - Modèle industriel - Tuyau polyuréthane													
				Support orientable à 180°									
		317	312	500	8 x 12	ISI 06	12	9	Pivotant	8 x 12		DPF 0812IS	
		377	312	900	10 x 14	ISI 06	10	9	Pivotant	10 x 14		DPF 1010IS	
		377	312	500	8 x 12	IRM 06	12	9	Pivotant	8 x 12		DPF 0812	
		377	312	900	10 x 14	IRM 06	10	9	Pivotant	10 x 14		DPF 1010	
		377	312	500	8 x 12	CSM 06	12	9	Pivotant	8 x 12		DPF 0812CSM	
		377	312	900	10 x 14	CSM 06	10	9	Pivotant	10 x 14		DPF 1010CSM	
		Série DPF SMO - Modèle mobile - Tuyau polyuréthane											
				Référence du support mobile seul : DPF SMON Référence de l'ensemble enrouleur + support : DPF SMO (DPF 0812 + DPF SMON)									
		377	312	500	8 x 12	IRM 06	12	8,5	Mural et mobile	8 x 12		DPF SMO	
		345	65						Support mobile seul			DPF SMON	
Série DGF - Grand modèle industriel - Tuyau caoutchouc													
		520	462	500	8 x 14	IRM 06	10	17	fixe	G 3/8 Femelle		DGF 0810	
		520	462	350	8 x 14	IRM 06	15	18,5	fixe	G 3/8 Femelle		DGF 0815	
		520	462	260	8 x 14	IRM 06	20	20	fixe	G 3/8 Femelle		DGF 0820	
		520	462	900	10 x 17	IRM 06	10	18	fixe	G 3/8 Femelle		DGF 1010	
		520	462	700	10 x 17	IRM 06	15	19	fixe	G 3/8 Femelle		DGF 1015	
		520	462	350	8 x 14	CSM 06	15	18,5	fixe	G 3/8 Femelle		DGF 0815CSM	
		520	462	260	8 x 14	CSM 06	20	20	fixe	G 3/8 femelle		DGF 0820CSM	
		520	462	1800	13 x 20	CSM 08	10	19	fixe	G 1/2 Mâle		DGF 1310CSM	
		520	462	1800	13 x 20	ISI 08	10	19	fixe	G 1/2 mâle		DGF 1310IS	
Support orientable pour enrouleur DGF													
									Pour DGF			DGF PIV	

ENROULEURS AIR COMPRIME A TAMBOUR OUVERT

Arrêt du tuyau	Pression P.N. 12 bar	Température 70°C	Matière Acier epoxy		Longévité	Anti chocs	Ergonomie du poste de travail
----------------	----------------------	------------------	---------------------	--	-----------	------------	-------------------------------

		A	B	Débit l/min	Diamètre int./ext	Equipé d'un raccord	Entrée tournante	Longueur m	Poids kg	Support intégré	REFERENCE
Série DMO - Modèle moyen - Tuyau caoutchouc											
		478	465	500	8 x 14	IRM 06	G 3/8 Femelle	10	16	Fixe	DMO 0810
		478	465	350	8 x 14	IRM 06	G 3/8 Femelle	15	17,5	Fixe	DMO 0815
		478	465	260	8 x 14	IRM 06	G 3/8 Femelle	20	19	Fixe	DMO 0820
		478	465	900	10 x 17	IRM 06	G 3/8 Femelle	10	17	Fixe	DMO 1010
		478	465	700	10 x 17	IRM 06	G 3/8 Femelle	15	19	Fixe	DMO 1015
		478	465	660	10 x 17	IRM 06	G 3/8 femelle	20	22	Fixe	DMO 1020
		478	465	350	8 x 14	CSM 06	G 3/8 Femelle	15	17.5	Fixe	DMO 0815CSM
		478	465	260	8 x 14	CSM 06	G 3/8 Femelle	20	19	Fixe	DMO 0820CSM
		478	465	700	10 x 17	CSM 06	G 3/8 Femelle	15	19	Fixe	DMO 1015CSM
		478	465	660	10 x 17	CSM 06	G 3/8 Femelle	20	22	Fixe	DMO 1020CSM
		478	465	1400	13 x 20	ISI 08	G 1/2 mâle	15	22	Fixe	DMO 1315IS
Série DVO - Modèle moyen - Tuyau polyuréthane tressé											
		460	447	500	10 x 14	IRM 06	G 3/8 Mâle	25	23	Fixe	DVO 1025
Série DGO - Grand modèle - Tuyau caoutchouc											
		485	480	500	10 x 17	IRM 06	G 3/8 Femelle	25	26	Fixe	DGO 1025
		485	480	1000	13 x 20	ISI 08	G 1/2 Mâle	20	27	Fixe	DGO 1320IS
		485	480	3000	16 x 23	ISG 11	G 1/2 Mâle	10	25	Fixe	DGO 1610
		485	480	1000	13 x 20	CSM 08	G 1/2 Mâle	20	27	Fixe	DGO 1320CSM

ENROULEURS AIR COMPRIME A TAMBOUR OUVERT

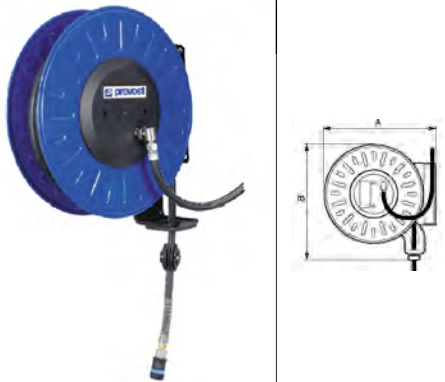
Arrêt du tuyau	Pression P.N. 12 bar	Température 70°C	Matière Acier epoxy		Longévité	Anti chocs	Ergonomie du poste de travail				
		A	B	Débit l/min	Diamètre int./ext	Equipé d'un raccord	Entrée tournante	Longueur m	Poids kg	Support intégré	REFERENCE
Série DLO - Modèle extra large - Tuyau caoutchouc											
		615	610	850	13 x 20	ISG 11	G 1/2 Mâle	30	39	Fixe	DLO 1330
		615	610	1700	16 x 23	ISG 11	G 1/2 Mâle	25	41	Fixe	DLO 1625
		615	610	2400	19 x 27	ISG 11	G 1 Mâle	20	42	Fixe	DLO 1920

ENROULEURS AIR COMPRIME SANS TUYAU

Arrêt du tuyau	Pression P.N. 12 bar	Température 70°C	Sécurité d'utilisation		Matière Acier époxy	Anti chocs	Ergonomie du poste de travail		
		A	B	Entrée tournante Gaz BSP	Poids kg	Capacité m	Sortie Gaz BSP	Support intégré	REFERENCE
Série DMO / Sans tuyau - Acier									
		478	465	G 3/8 femelle	15	15	G 3/8 femelle	Fixe	DMO N







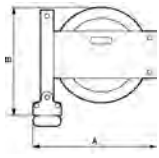

SUPPORT ORIENTABLE POUR ENROULEURS

Matière Acier	Efficacité	Longévité	Sécurité d'utilisation
		Modèle d'enrouleurs	REFERENCE
Support orientable pour enrouleur ouvert			
		pour DMO	DMO PIV
		Pour DGO	DGO PIV
		Pour DLO	DLO PIV

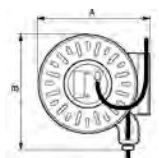

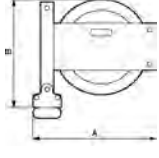

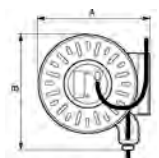
ENROULEUR MANUEL

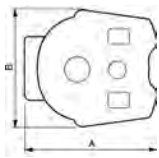
Facilement transportable	Facilité d'enroulement et de déroulement	Pression P.N.12 bar	Température -4°C +70°C	Matière Carter et support acier				
		Débit l/min	Diamètre int./ext mm	Equipé d'un raccord rapide	Longueur m	Poids kg	Equipé d'un embout	REFERENCE
Série DMP - Tuyau polyuréthane								
		Fixe mural ou portable orientable						
			8 x 12	ISI 06	30	8,4	IRP 06	DMP 0830IS
			10 x 14	ISI 06	25	8,4	IRP 06	DMP 1025IS

ENROULEURS POUR EAU BASSE PRESSION

Longévité	Economique Préserve les flexibles	Arrêt du tuyau	Pression 10 bar	Température 60°C	Matière Acier	Anti chocs	Sécurité d'utilisation			
		A	B	Diamètre int./ext. en mm	Entrée tournante	Longueur m	Poids kg	Sortie Raccord eau	Support intégré	REFERENCE
Série DMO - DGO / Acier avec tuyau caoutchouc - Qualité alimentaire										
		478	465	16 x 24	G 1/2 mâle	10	20	ELS 091103	Fixe	DMO 1610LS
		485	480	16 x 24	G 1/2 mâle	15	25	ELS 091103	Fixe	DGO 1615LS
Série DLO - Acier avec tuyau caoutchouc - Qualité alimentaire										
		615	610	16 x 24	G 1/2 femelle	25	44	ELS 091103	Fixe	DLO 1625LS
		615	610	19 x 28	G 3/4 femelle	20	42	ELS 091104	Fixe	DLO 1920LS
Série DMOI - DGOI / Inox 304 avec tuyau caoutchouc - Qualité alimentaire - Eau basse pression										
		478	465	16 x 24	G 1/2 mâle	10	20	ELS 091103	Fixe	DMOI 1610LS
		485	480	16 x 24	G 1/2 mâle	15	25	ELS 091103	Fixe	DGOI 1615LS
Série DLOI / Inox 304 avec tuyau caoutchouc - Qualité alimentaire - Eau basse pression										
		615	610	16 x 24	G 1/2	25	44	ELS 091103	Fixe	DLOI 1625LS
		615	610	19 x 28	G 3/4	20	42	ELS 091104	Fixe	DLOI 1920LS
Enrouleur carter polyamide gris avec tuyau PVC										
		620	470	13 x 20	13 x 20	20	10	livré sans raccord	Orientable	DLS 1320N

ENROULEURS POUR EAU CHAUDE HAUTE PRESSION

Longévité	Economique Préserve les tuyaux	Arrêt du tuyau	Pression 400 bar	Température 150°C	Matière Acier	Anti chocs	Sécurité d'utilisation					
		A	B	Diamètre int./ext. en mm	Entrée tournante Gaz BSP	Longueur m	Poids kg	Support intégré	Taroudage	Sortie	REFERENCE	
Série DMO-DGO - Acier haute pression - tuyau renforcé HP												
		478	465	8 x 17	G 3/8 femelle	15	16	Fixe	G 3/8 + 22 x 150		DMO 0815HP	
		485	480	8 x 17	G 3/8 femelle	20	21	Fixe	G 3/8 + 22 x 150		DGO 0820HP	
Série DMO-DGO - Inox - Tuyau renforcé HP - Eau chaude Haute pression												
		478	465	8 x 17	G 3/8 femelle	15	16	Fixe		G 3/8 + 22 x 150	DMO 0815HPI	
		485	480	8 x 17	G 3/8 femelle	20	21	Fixe		G 3/8 + 22 x 150	DGO 0820HPI	
Série DMO-DGO - Inox haute pression - tuyau renforcé HP												
				8 x 17	G 3/8 + 22 x 150 sur machine eau chaude	3	1,3	-	G 3/8 + 22 x 150 sur machine haute pression		DMG KITHP3	
				8 x 17	G 3/8 + 22 x 150 sur machine eau chaude	6	2,7	-	G 3/8 + 22 x 150 sur machine haute pression		DMG KITHP6	

ENROULEURS EAU CHAUDE SANS TUYAU HAUTE ET BASSE PRESSION



Arrêt du tuyau	Economique Préserve les tuyaux	Longévité	Pression 400 bar	Température 150°C	Matière Acier époxy	Anti chocs	Sécurité d'utilisation
----------------	-----------------------------------	-----------	---------------------	----------------------	------------------------	------------	---------------------------

		A	B	Capacité m	Entrée tournante Gaz BSP	Poids kg	Sortie Gaz BSP	Support intégré	REFERENCE
Série DMO - DGO / Sans tuyau - Acier haute pression									
		478	465	15	G 3/8 femelle	15	G 3/8 mâle	Fixe	DMO NHP
		485	480	20	G 3/8 femelle	20	G 3/8 mâle	Fixe	DGO NHP
Série DMO - DGO / Sans tuyau - Inox 304 haute pression									
		478	465	15	G 3/8 femelle	15	G 3/8	Fixe	DMO NHPI
		485	480	20	G 3/8 femelle	20	G 3/8	Fixe	DGO NHPI
Série DMO - DGO / Sans tuyau - Inox 304 basse pression									
		478	465	15	G 1/2 mâle	15	G 1/2	Fixe	DMO NI
		485	480	20	G 1/2 mâle	20	G 1/2	Fixe	DGO NI



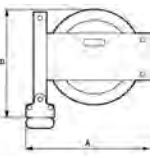

SUPPORT PIVOTANT INOX POUR ENROULEURS

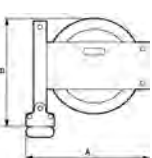
Efficacité	Longévité	Matière Acier inox	Sécurité d'utilisation
		Modèle d'enrouleur	REFERENCE
Support orientable inox pour enrouleur ouvert			
		Pour DMOI	DMOI PIV
		Pour DGOI	DGOI PIV
		Pour DLOI	DLOI PIV



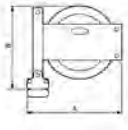

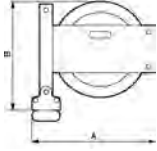
ENROULEURS POUR GRAISSE ET HUILE

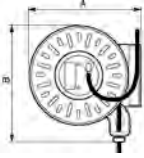
Sécurité d'utilisation du tuyau	Ergonomie Facilité d'usage	Support intégré fixe	Fluide Graisse et huile	Matière Carter acier epoxy	Arrêt du tuyau						
A	B	Diamètre int./ext en mm	Entrée tournante	Longueur m	Poids kg	Sortie Gaz BSP	Pression bar	Température °C	REFERENCE		
Série DMO-DGO Oil - Huile moyenne pression											
		478	465	12.7 X 19	G 1/2 mâle	10	18	G 1/2 mâle	60	40	DMO 1310OIL
		485	480	12.7 x 19	G 1/2 mâle	15	23	G 1/2 mâle	60	40	DGO 1315OIL
		485	480	12.7 x 19	G 1/2 mâle	20	26.5	G 1/2 mâle	60	40	DGO 1320OIL
Série DMO-DGO GR - Graisse haute pression											
		478	465	6.3 x 15.5	G 1/4 femelle	10	18,5	G 1/4 mâle	400	100	DMO 0610GR
		478	465	6.3 x 15.5	G 1/4 femelle	15	20,5	G 1/4 mâle	400	100	DMO 0615GR
		485	480	6.3 x 15.5	G 1/4 femelle	20	27	G 1/4 mâle	400	100	DGO 0620GR

ENROULEURS INOX AIR - EAU HAUTE ET BASSE PRESSION

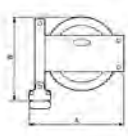
Longévité	Economique Préserve les flexibles	Arrêt du tuyau	Température 60°C		Matière Acier	Anti chocs	Sécurité d'utilisation				
A	B	Diamètre int./ ext. en mm	Entrée tournante Gaz BSP	Longueur m	Poids kg	Support intégré	Sortie	Capacité m	Equipé d'un raccord rapide	Débit sans raccord l/min	REFERENCE
Série DMO-DGO - Inox - Tuyau renforcé HP - Eau chaude Haute pression											
		478	465	8 x 17	G 3/8 femelle	15	16	Fixe	G 3/8 + 22 x 150		DMO 0815HPI
		485	480	8 x 17	G 3/8 femelle	20	21	Fixe	G 3/8 + 22 x 150		DGO 0820HPI
Série DMOI - DGOI / Inox 304 avec tuyau caoutchouc - Qualité alimentaire - Eau basse pression											
		478	465	16 x 24	G 1/2 mâle	10	20	Fixe	ELS 091103		DMOI 1610LS
		485	480	16 x 24	G 1/2 mâle	15	25	Fixe	ELS 091103		DGOI 1615LS
Série DLOI / Inox 304 avec tuyau caoutchouc - Qualité alimentaire - Eau basse pression											
		615	610	16 x 24	G 1/2	25	44	Fixe	ELS 091103		DLOI 1625LS
		615	610	19 x 28	G 3/4	20	42	Fixe	ELS 091104		DLOI 1920LS

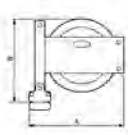

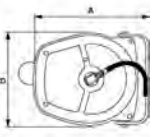
ENROULEURS INOX AIR - EAU HAUTE ET BASSE PRESSION

Longévité	Economique Préserve les flexibles	Arrêt du tuyau	Température 60°C		Matière Acier	Anti chocs	Sécurité d'utilisation						
Série DMO - DGO / Sans tuyau - Inox 304 haute pression		A	B	Diamètre int./ ext.en mm	Entrée tournante Gaz BSP	Longueu m	Poids kg	Support intégré	Sortie	Capacité m	Equipé d'un raccord rapide	Débit sans raccord l/min	REFERENCE
		478	465		G 3/8 femelle		15	Fixe	G 3/8	15			DMO NHPI
		485	480		G 3/8 femelle		20	Fixe	G 3/8	20			DGO NHPI
Série DMO - DGO / Sans tuyau - Inox 304 basse pression													
		478	465		G 1/2 mâle		15	Fixe	G 1/2	15			DMO NI
		485	480		G 1/2 mâle		20	Fixe	G 1/2	20			DGO NI
Série DSF - Modèle INOX - Tuyau polyuréthane tressé - Air comprimé													
		260	218	8 x 12	8 x 12	5	3	Pivotant			ESI 07HE	650	DSFI 0805ESHE
		Support orientable à 180°											

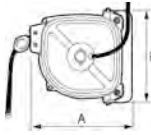
ENROULEURS INOX AIR - EAU HAUTE ET BASSE PRESSION



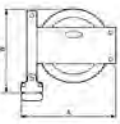

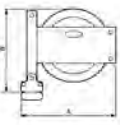
Longévité	Economique Préserve les flexibles	Arrêt du tuyau	Température 60°C	Matière Acier	Anti chocs	Sécurité d'utilisation							
		A	B	Diamètre int./ ext.en mm	Entrée tournante Gaz BSP	Longueur m	Poids kg	Support intégré	Sortie	Capacité m	Equipé d'un raccord rapide	Débit sans raccord l/min	REFERENCE
Série DRF - Modèle INOX - Tuyau polyuréthane - Air comprimé													
Support orientable à 180°													
 													
		370	337	10 x 14	Fixe 10x14	12	6,3	Pivotant			ESI 07HE	800	DRFI 1012ESHE

ENROULEURS POUR INSTALLATIONS SOUDURE

Température 60 °C	Matière Peinture époxy	Pression de l'enrouleur 20 bar	Sécurité	Application Soudage, découpage	Fluide Oxygène, acétylène	Arrêt	Facilité d'enroulement et de déroulement Préserve les tuyaux		
		A	B	Diamètre int./ext en mm	Entrée tournante Gaz BSP	Longueur m	Sortie	Support intégré	REFERENCE
SERIE DGO - Tuyaux jumelés sans raccord sécurité ISOFLAM									
 									
		485	480	10 x 17	Oxygène: G 3/8 femelle droit Acétylène: G 3/8 femelle gauche	15	10 x 17	Fixe	DGO 1015OA
SERIE DGO - Tuyaux jumelés avec raccord sécurité ISOFLAM									
 									
		485	480	10 x 17	Oxygène: G 3/8 femelle droit Acétylène: G 3/8 femelle gauche	15	Oxygène : raccord de sécurité isoflam protection du soudeur SIO 061810S2 Acétylène : raccord de sécurité isoflam protection du soudeur SIA 061810S2	Fixe	DGO 1015SIC

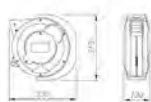
ENROULEURS DE CÂBLE ELECTRIQUE

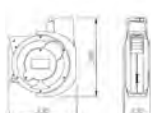
Support intégré pivotant	Température -5° à + 40°C	Matière Polypropylène antichoc et isolant	Sécurité d'utilisation	Protection Enrouleur : IP42 Baladeuse : IP55	Facilité d'enroulement et de déroulement du câble	Puissance baladeuse 11 W
--------------------------	--------------------------	---	------------------------	--	---	--------------------------

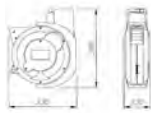
		A	B	Longueur m	Poids kg	Section câble	Matière câble	Puissance KW	Alimentation	REFERENCE
Enrouleur de câble électrique										
		375	175	14 m (+ 1 m à l'extérieur)	5	3 G x 1,5 mm ²	PVC H05V V-F	1,2 KW enroulé 1,8 KW déroulé	230 V	DEL 31514
		490	215	17 m (+ 2 m à l'extérieur)	8,8	3 G x 2,5 mm ²	Caoutchouc H07 RN-F	2 KW enroulé 3 KW déroulé	230 V	DEL 32520
Enrouleur de câble avec baladeuse fluorescente 230 V										
		375	175	14 m (+ 1,5 m à l'extérieur)	5	2 x 1 mm ²	Caoutchouc H05 RN-F		230 V	DEL BA230
Enrouleur de câble avec baladeuse fluorescente 24 V										
		Enrouleur avec alimentation en 24 V - Prévoir un transformateur en cas d'alimentation en 220/230 V.								
		375	175	14 m (+ 1,5 m à l'extérieur)	5	2 x 1 mm ²	Caoutchouc H05 RN-F		24 V	DEL BA24

PIÈCES DÉTACHÉES POUR ENROULEURS DSF

PIÈCES DÉTACHÉES POUR ENROULEURS DMF

DSF

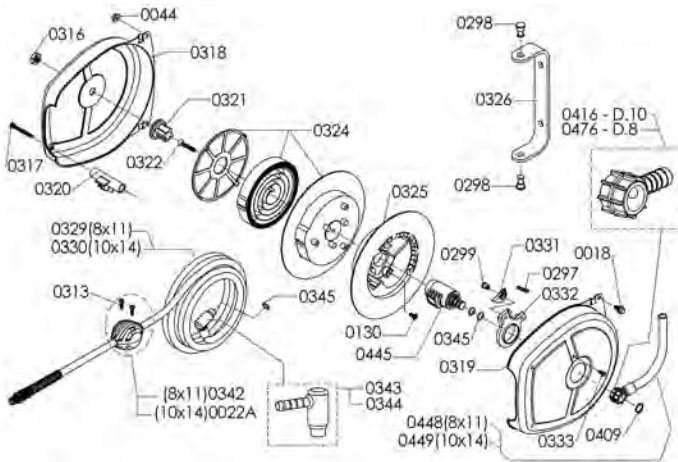

DMF

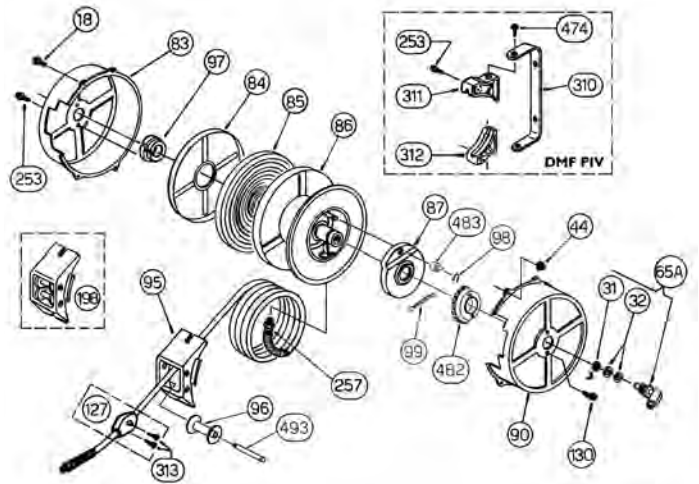

Repère	Référence	Désignation
18	DMG 0018	Vis te M6 x 10
22A	DMG BC14	Butée fin de course Ø 10 x 14
44	DMG 0044	Ecrou M6
130	DMG 0130	Vis TC 5 x 12
297	DMG 0297	Ressort de rappel cliquet
298	DMG 0298	Axe de support pivotant
299	DMG 0299	Pivot de cliquet
313	DMG 0313	Vis TC 5 x 16
316	DMG 0316	Ecrou M6
317	DMG 0317	Vis TC M5 x 67
318	DMG 0318	Demi-carter gauche
319	DMG 0319	Demi-carter droit
320	DMG 0320	Entretoise L = 68
321	DMG 0321	Moyeu d'entraînement
322	DMG 0322	Vis TC 6 x 20
324	DMG 0324	Ressort
325	DMG 0325	Demi-tambour
326	DMG 0326	Support pivotant
329	DMG 0329	Tuyau PU Ø 8 x 11 L = 5 m
330	DMG 0330	Tuyau PU Ø 10 x 14 L = 3 m
331	DMG 0331	Cliquet
332	DMG 0332	Support de cliquet
333	DMG 0333	Vis TC M4 x 10
342	DMF BC12	Butée fin de course Ø 8 x 11
343	DMG 0343	Jonction pour tuyau Ø 8
344	DMG 0344	Jonction pour tuyau Ø 10
345	DMG 0345	Joint torique
409	DMG 0409	Circlips
416	DMG 0416	Raccord en plastique D.10
445	DMG 0445	Moyeu raccord tournant
448	DMG 0448	Tuyau 8x11 L=1 m
449	DMG 0449	Tuyau 10x14 L=1 m
476	DMG 0476	Raccord en plastique D.8

Repère	Référence	Désignation
18	DMG 0018	Vis te M 6 x 10
31	DMG 0031	Joint basse pression
32	DMG 0032	Rondelle d'appui ép. 4
44	DMG 0044	Ecrou M6
65A	DMG 65A	Ensemble de raccordement
83	DMG 0083	Demi carter gauche
84	DMG 0084	Carter ressort
85	DMG 0085	Ressort
86	DMG 0086	Tambour
87	DMG 0087	Disque interne tambour
90	DMG 0090	Demi carter droit
95	DMG 0095	Embout support rouleau
96	DMG 0096	Rouleau guide tuyau
97	DMG 0097	Moyeu d'entraînement
98	DMG 0098	Circlip 8E
99	DMG 0099	Ressort de cliquet
127	DMF BC12	Butée de fin de course
154	DMG 0154	Écrou M6
130	DMG 0130	Vis autotaraudeuse 5 x 12
198	DMG 0198	Ensemble support rouleaux
253	DMG 0253	Vis te 6 x 21
257	DMG 0257	Jonction pour tube Ø 8
310	DMG 0310	Étrier
311	DMG 0311	Demi support droit
312	DMG 0312	Demi support gauche
313	DMG 0313	Vis TC 5 x 16
474	DMG 0474	Vis te FR 6 x 20
482	DMG 0482	Couronne dentée
483	DMG 0483	Cliquet
493	DMG 0793	Tige
	DMF TC0810	Tuyau 8 x 12 L = 10 m
	ENROULEX 8	Tuyau souple au mètre 8 x 12
	DMF PIV	Support pivotant

PIÈCES DÉTACHÉES POUR ENROULEURS DRF

DRF 0815 et DRF 1012

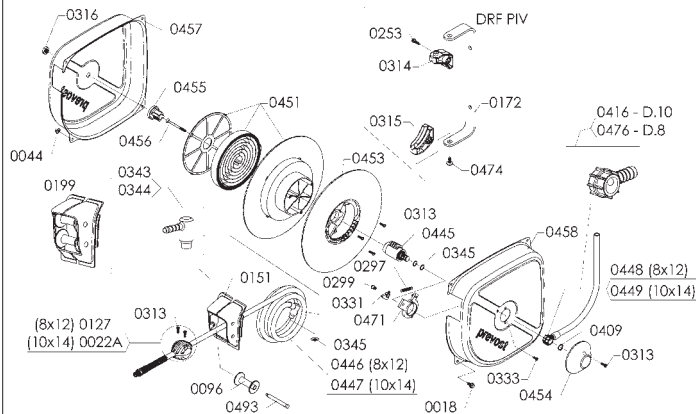

Repère	Référence	Désignation
18	DMG 0018	Vis te M6 x 10
0022A	DMO BC14	Butée D.14 (1/4")
44	DMG 044	Ecrou M 6 FR
96	DMG 0096	Rouleau guide tuyau
127	DMF BC12	Butée D.12
151	DMG 0151	Support rouleau
172	DMG 0172	Etrier
199	DMG 0199	Ensemble guide tuyau
253	DMG 0253	Vis te 6x21hilo
297	DMG 0297	Ressort de cliquet
299	DMG 0299	Pivot de cliquet
313	DMG 0313	Vis tc 5x16 hilo
314	DMG 0314	Demi support droit
315	DMG 0315	Demi support gauche
316	DMG 0316	Ecrou M 12
331	DMG 0331	Cliquet
333	DMG 0333	Vis tc M 4x10
343	DMG 0343	Jonction pour tuyau ø 8
344	DMG 0344	Jonction pour tuyau ø 10
345	DMG 0345	Joint torique
409	DMG 0409	Circlip A 14
416	DMG 0416	Raccord en plastique D.10
445	DMG 0445	Moyeu raccord tournant
446	DMG 0446	Tuyau 8x12 L=15 m
447	DMG 0447	Tuyau 10x14 L=12 m
448	DMG 0448	Tuyau 8x12 L=1 m
449	DMG 0449	Tuyau 10x14 L=1 m
451	DMG 0451	Ressort
453	DMG 0453	Demi-tambour
454	DMG 0454	Couvercle en plastique
455	DMG 0455	Moyeu de ressort
456	DMG 0456	Vis tsp torx 6x66
457	DMG 0457	Demi-carter côté ressort
458	DMG 0458	Demi-carter côté raccord
471	DMG 0471	Support de cliquet
474	DMG 0474	Vis Tefr 6x20 hilo
476	DMG 0476	Raccord en plastique D.8
493	DMG 0493	Tige pour rouleau
	DRFPV	Support pivotant

PIÈCES DÉTACHÉES POUR ENROULEURS DRF

DRF 0812 et DRF 1010

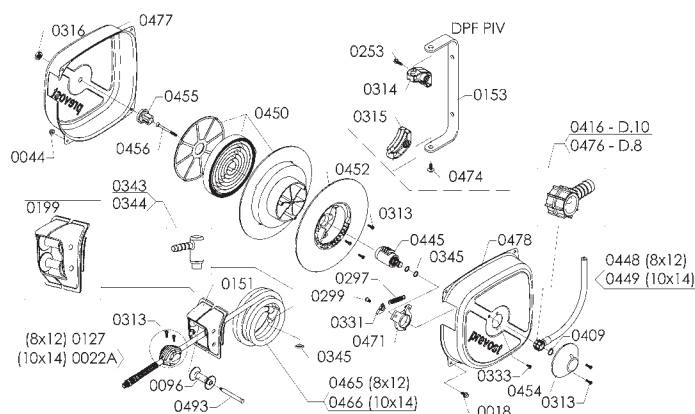

Repère	Référence	Désignation
18	DMG 0018	Vis te M6 x 10
0022A	DMO BC14	Butée D.14 (1/4")
44	DMG 044	Ecrou M 6 FR
96	DMG 0096	Rouleau guide tuyau
127	DMF BC12	Butée D.12
151	DMG 0151	Support rouleau
153	DMG 0153	Etrier
199	DMG 0199	Ensemble guide tuyau
253	DMG 0253	Vis te 6x21hilo
297	DMG 0297	Ressort de cliquet
299	DMG 0299	Pivot de cliquet
313	DMG 0313	Vis tc 5x16 hilo
314	DMG 0314	Demi support droit
315	DMG 0315	Demi support gauche
316	DMG 0316	Ecrou M 12
331	DMG 0331	Cliquet
333	DMG 0333	Vis tc M 4x10
343	DMG 0343	Jonction pour tuyau ø 8
344	DMG 0344	Jonction pour tuyau ø 10
345	DMG 0345	Joint torique
409	DMG 0409	Circlip A 14
416	DMG 0416	Raccord en plastique D.10
445	DMG 0445	Moyeu raccord tournant
448	DMG 0448	Tuyau 8x12 L=1 m
449	DMG 0449	Tuyau 10x14 L=1 m
450	DMG 0450	Ressort
452	DMG 0451	Demi-tambour
454	DMG 0454	Couvercle en plastique
455	DMG 0455	Moyeu de ressort
456	DMG 0456	Vis tsp torx 6x66
465	DMG 0465	Tuyau 8x12 L=12 m
466	DMG 0466	Tuyau 10x14 L=10 m
471	DMG 0471	Support de cliquet
474	DMG 0474	Vis Tefr 6x20 hilo
476	DMG 0476	Raccord en plastique D.8
477	DMG 0477	Demi-carter côté ressort
478	DMG 0478	Demi-carter côté raccord
493	DMG 0493	Tige pour rouleau
	DPF PIV	Support pivotant

PIÈCES DÉTACHÉES POUR ENROULEURS DPF

PIÈCES DÉTACHÉES POUR ENROULEURS DGF

DPF

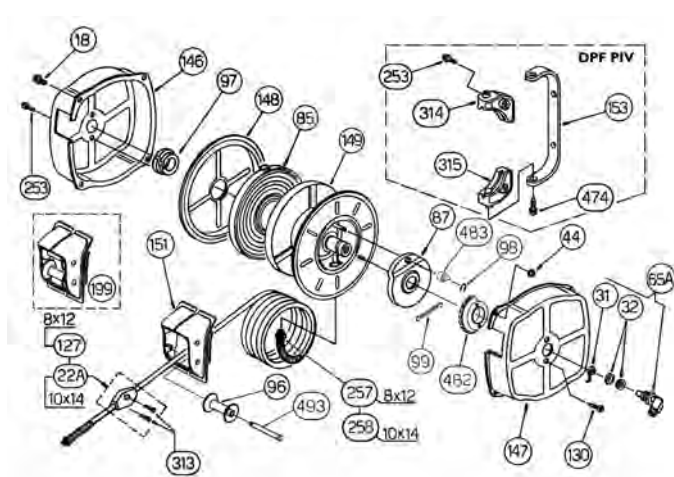

DGF

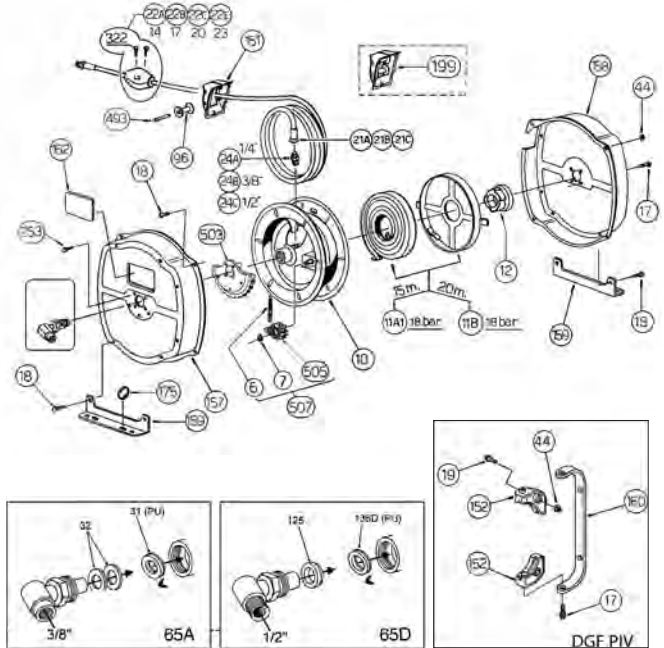

Repère	Référence	Désignation
18	DMG 0018	Vis te M 6 x 10
22A	DMO BC14	Butée D.14
31	DMG 0031	Joint basse pression
32	DMG 0032	Rondelle d'appui
44	DMG 0044	Ecrou M6
65A	DMG 65A	Raccord complet 3/8"
85	DMG 0085	Ressort
87	DMG 0087	Disque interne tambour
96	DMG 0096	Rouleau guide tuyau
97	DMG 0097	Moyeu d'entraînement
98	DMG 0098	Circlip 8E
99	DMG 0099	Ressort de cliquet
127	DMF BC12	Butée de fin de course
130	DMG 0130	Vis autotaraudeuse 5 x 12
146	DMG 0146	Demi carter gauche
147	DMG 0147	Demi carter droit
148	DMG 0148	Carter ressort
149	DMG 0149	Tambour
151	DMG 0151	Embout support rouleau
153	DMG 0153	Support pivotant
199	DMG 0199	Ensemble support rouleaux
253	DMG 0253	Vis te 6 x 21
257	DMG 0257	Jonction pour tube Ø 8
258	DMG 0258	Jonction pour tube Ø 10
313	DMG 0313	Vis TC 5 x 16
314	DMG 0314	Demi support droit
315	DMG 0315	Demi support gauche
474	DMG 0474	Vis te FR 6 x 20
482	DMG 0482	Couronne dentée
483	DMG 0483	Cliquet
493	DMG 0793	Tige
	DPF TC0812	Tuyau 8 x 12 L = 12 m
	DPF TC1010	Tuyau 10 x 14 L = 10 m
	ENROULEX 8	Tuyau souple au mètre 8 x 12
	ENROULEX 10	Tuyau souple au mètre 10 x 14
	DPF PIV	Support pivotant

Repère	Référence	Désignation
6	DMG 0006	Ressort de rappel cliquet
7	DMG 0007	Circlips Ø 10
10	DMG 0010	Tambour
11A1	DMG 0011A1	Ressort tuyau 10m et 15m 18 bar
11B	DMG 0011B	Ressort tuyau 20m
12	DMG 0012	Moyeu d'entraînement
17	DMG 0017	Vis te M6 x 16
18	DMG 0018	Vis te M6 x 10
21A	DMG 0021A	Jonction pour tube Ø 8
21B	DMG 0021B	Jonction pour tube Ø 10
21C	DMG 0021C	Jonction pour tube Ø 13
22A	DMO BC14	Butée de fin de course 8 x 14
22B	DMO BC17	Butée de fin de course 10 x 17
22C	DGO BC20	Butée de fin de course 13 x 20
22E	DGO BC23	Butée de fin de course 16 x 23
24A	DMG 0024A	Mamelon 1/4" (8 x 14)
24B	DMG 0024B	Mamelon 3/8" (10 x 17)
24C	DMG 0024C	Mamelon 1/2" (13x20 - 16x27)
31	DMG 0031	Joint basse pression Ø12-22
32	DMG 0032	Rondelle d'appui Ø 12-24
44	DMG 0044	Ecrou M6
65A	DMG 65A	Entrée femelle 3/8"
65D	DMG 0065D	Entrée mâle 1/2"
96	DMG 0096	Rouleau guide tuyau
125	DMG 0125	Rondelle d'appui Ø16-24
136D	DMG 0136D	Joint basse pression Ø16-22
151	DMG 0151	Embout support rouleau
152	DMG 0152	Demi support pour étrier
157	DMG 0157	Demi carter droit
158	DMG 0158	Demi carter gauche
159	DMG 0159	Etrier de fixation
160	DMG 0160	Etrier pour pivot
162	DMG 0162	Porte
175	DMG 0175	Bague Ø 32
199	DMG 0199	Ensemble support rouleaux
253	DMG 0253	Vis te M6 x 16
322	DMG 0322	Vis TC 6 x 20
493	DMG 0793	Tige
503	DMG 0503	Couronne dentée
505	DMG 0505	Cliquet
507	DMG 0507	Kit de cliquet
	DMG TC 0810	Tuyau caout. 8 x 14 - 10m
	DMG TC 0815	Tuyau caout. 8 x 14 - 15m
	DMG TC 0820	Tuyau caout. 8 x 14 - 20m
	DMG TC 1010	Tuyau caout. 10 x 17 - 10m
	DMG TC 1015	Tuyau caout. 10 x 17 - 15m
	DMG TC 1310	Tuyau caout. 13 x 20 - 10m
	DGF PIV	Support pivotant

PIÈCES DÉTACHÉES POUR ENROULEURS DMO ET DMO INOX

DMO

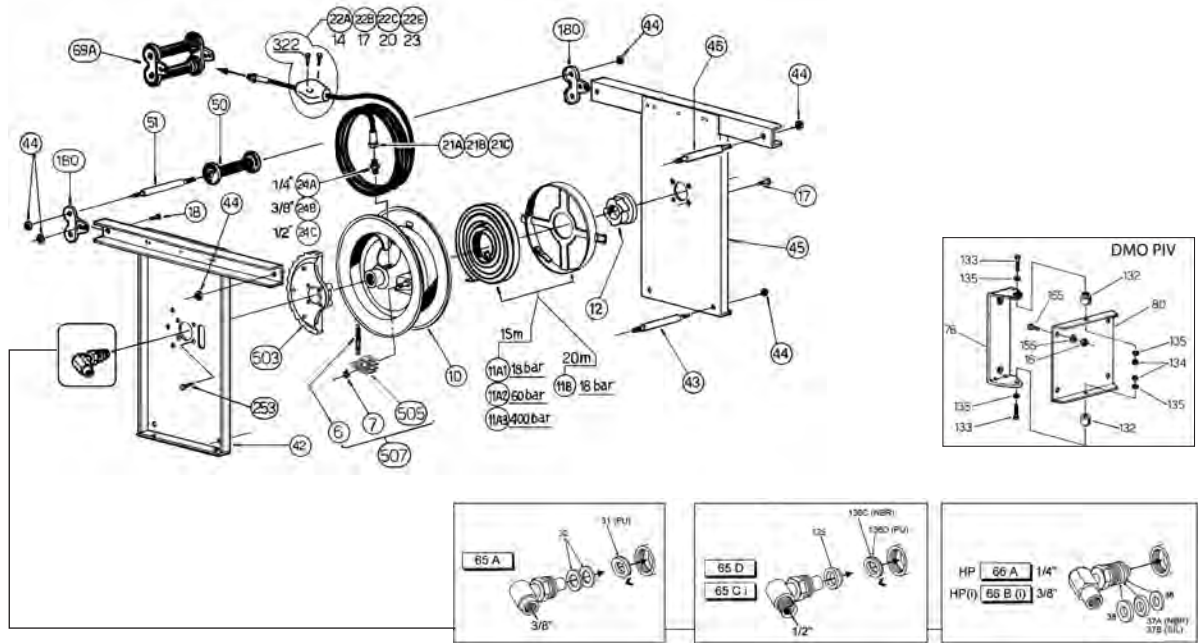

Repère	Référence	Désignation
6	DMG 0006	Ressort de rappel
7	DMG 0007	Circlips Ø 10
10	DMG 0010	Tambour
11A1	DMG 011A1	Ressort tube 10/15m-18 bar
11A2	DMG 011A2	Ressort tube 10/15m-60 bar
11A3	DMG 011A3	Ressort tube 10/15m-400 bar
11B	DMG 011B	Ressort tube 20m-18 bar
12	DMG0012	Moyeu d'entraînement
16	DMG 0016	Ecrou M10
17	DMG 0017	Vis te M6 x 16
18	DMG 0018	Vis te M6 x 10
21A	DMG 0021A	Jonction pour tube Ø 8
21B	DMG 0021B	Jonction pour tube Ø 10
21C	DMG 0021C	Jonction pour tube Ø 13
22A	DMG BC14	Butée caoutchouc 8 x 14
22B	DMO BC17	Butée caoutchouc 10 x 17
22C	DGO BC20	Butée caoutchouc 13 x 20
24A	DMG 0024A	Mamelon pour tube 8 x 14
24B	DMG 0024B	Mamelon pour tube 10 x 17
24C	DMG 0024C	Mamelon pour tube 13 x 20
31	DMG 0031	Joint basse pression Ø 12-24
32	DMG 0032	Rondelle d'appui
36	DMG 0036	Rondelle laiton
37A	DMG 0037A	Joint HP 1/4"
37B	DMG 0037B	Joint HP 3/8"
38	DMG 0038	Rondelle d'appui HP
42	DMG 0042	Flanc gauche
43	DMG 0043	Tirant L : 115mm
44	DMG 0044	Ecrou M6
45	DMG 0045	Flanc droit
46	DMG 0046	Tirant L : 119mm
50	DMG 0050	Rouleau L=122 mm
51	DMG 0051	Tiran L: 69 mm
65A	DMG 0065A	Raccord complet 3/8"
65D	DMG 0065D	Raccord complet 1/2"
66A	DMG 0066A	Raccord HP 1/4"
66B	DMG 66B	Raccord HP 3/8"
69A	DMG 0069A	Ensemble guide tuyau
76	DMG 0076	Support
80	DMG 0080	Etrier
125	DMG 0125	Rondelle d'appui Ø 16-24
132	DMG 0132	Bague
133	DMG 0133	Vis M8 x 45
134	DMG 0134	Ecrou M8
135	DMG 0135	Rondelle Ø 8
136D	DMG 0136D	Joint basse pression Ø 16-22
155	DMG 0155	Vis M10 x 20
156	DMG 0156	Rondelle Ø 10
180	DMG 0180	Support tuyau
253	DMG 0253	Vis te 6 x 21
322	DMG 0322	Vis TC 6 x 20
503	DMG 0503	Conronne dentée
505	DMG 0505	Cliquet
507	DMG 0507	Kit de cliquet

Repère	Référence	Désignation
	DMG TC 0810	Tuyau caout. 8 x 14 - 10m
	DMG TC 0815	Tuyau caout. 8 x 14 - 15m
	DMG TC 0820	Tuyau caout. 8 x 14 - 20m
	DMG TC 1010	Tuyau caout. 10 x 17 - 10m
	DMG TC 1015	Tuyau caout. 10 x 17 - 15m
	DMG TC 1020	Tuyau caout. 10 x 17 - 20m
	DMG TC 1315	Tuyau caout. 13 x 20 - 15m
	DMG TC 1310OIL	Tuyau caout. 13 x 20 - 20m
	DMG TC 1615LS	Tuyau caout. 16 x 24 - 15m
	DMG TC 0610GR	Tuyau caout. 6 x 16 - 10m
	DMG TC 0615GR	Tuyau caout. 6 x 16 - 15m
	DMG HP 0815	Tuyau HP 8 x 17 - 15m
	DMO PIV	Support pivotant

Pièces spécifiques pour DMO INOX		
Repère	Référence	Désignation
6	DMG 0006i	Ressort de rappel cliquet
7	DMG 0007i	Circlips Ø 10
10	DMG 0010i	Tambour
11A	DMG 0011Ai	Ressort pour tube 10 et 15m
16	DMG 0016i	Ecrou M10
17	DMG 0017i	Vis te M6 x 16
18	DMG 0018i	Vis te M6 x 10
24B	DMG 0024Bi	Mamelon pour tube 8x17
24C	DMG 0024Ci	Mamelon pour tube 13x20 & 16x23
42	DMG 0042i	Flanc gauche
43	DMG 0043i	Tirant L : 115mm
44	DMG 0044i	Ecrou M6
45	DMG 0045i	Flanc droit
46	DMG 0046i	Tirant L : 119mm
51	DMG 0051i	Tirant L : 123mm
65Ci	DMG 0065Ci	Raccord complet 1/2"
66Bi	DMG 66BX	Raccord complet HP 3/8"
69A	DMG 0069Ai	Ensemble guide tuyau
76	DMG 0076i	Support
80	DMG 0080i	Etrier
132	DMG 0132i	Bague
133	DMG 0133i	Vis M8 x 45
134	DMG 0134i	Ecrou M8
135	DMG 0135i	Rondelle Ø 8
136Ci	DMG 0136Ci	Joint basse pression Ø 16-22
155	DMG 0155i	Vis M10x20
156	DMG 0156i	Rondelle Ø10
180	DMG 0180i	Support rouleaux
253i	DMG 0253	Vis te 6 x 21
507	DMG 0507i	Kit de cliquet

PIÈCES DÉTACHÉES POUR ENROULEURS DVO

DVO

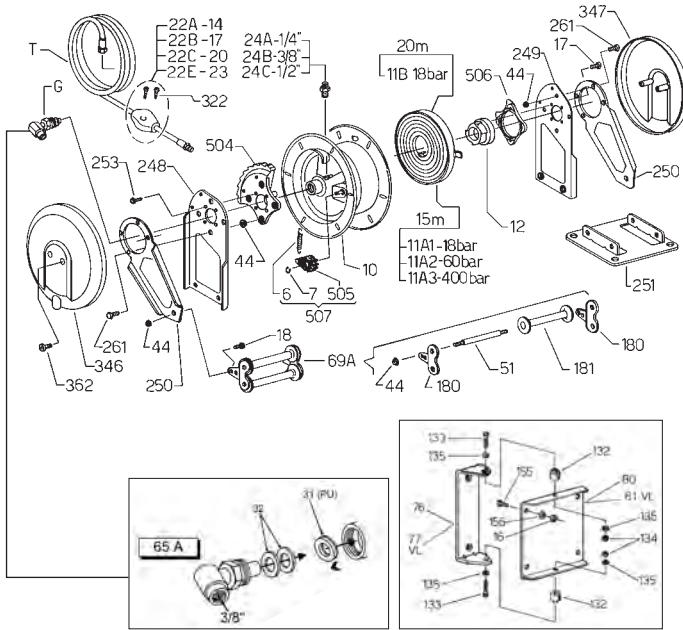

Repère	Référence	Désignation
6	DMG 0006	Ressort de cliquet
7	DMG 0007	Ciclipis D. 10
10	DMG 0010	Tambour
011 A1	DMG 011A1	Ressort 15 m 18 bar
011 A2	DMG 011A2	Ressort 15 m 60 bar
011 A3	DMG 0011A3	Ressort 15 m 400 bar
011 B	DMG 011B	Ressort 20 m 18 bar
12	DMG 0012	Moyeu de ressort
16	DMG 0016	Ecrou M10
17	DMG 0017	Vis TE M 6x16
18	DMG 0018	Vis TE M 6x10
022 A	DMG 022A	Butée D.14 (1/4")
022 B	DMG 022B	Butée D.17 (3/8")
022 C	DGO BC20	Butée D.20 (1/2")
022 E	DGO BC23	Butée D.23 (5/8")
024 A	DMG 0024A	Mamelon Double 1/2"-1/4"
024 B	DMG 0024B	Mamelon Double 1/2"-3/8"
024 C	DMG 0024C	Mamelon Double 1/2"-1/2"
31	DMG 0031	Joint
32	DMG 0032	Rondelle
44	DMG 0044	Ecrou M6
51	DMG 0051	Tirant L = 123
065A	DMG 0065A	Raccord tournant
069 A	DMG 0069A	Guide Tuyau Mod. A
76	DMG 0076	Support
80	DMG 0080	Etrier
132	DMG 0132	Bague
133	DMG 0133	Vis M 8x45
134	DMG 0134	Ecrou M8
135	DMG 0135	Rondelle D. 8
155	DMG 0155	Vis M 10x20
156	DMG 0156	Rondelle D. 10
180	DMG 0180	Support rouleaux
181	DMG 0181	Rouleau L = 122
248	DMG 0248	Flanc gauche
249	DMG 0249	Flanc droit
250	DMG 0250	Bras
251	DMG 0251	Plaque MOD. V
253	DMG 0253	Vis TE 6x21 hilo
261	DMG 0261	Vis TE M 6x12
322	DMG 0322	Vis TC 6x20 hilo
346	DMG 0346	Couvercle en plastique
347	DMG 0347	Couvercle en plastique
362	DMG 0362	Vis TC M 6x16
504	DMG 0504	Couronne dentée
505	DMG 0505	Cliquet
506	DMG 0506	Collier
507	DMG 507	Kit cliquet
	G	Raccord tournant
	T	Tuyau flexible

PIÈCES DÉTACHÉES POUR ENROULEURS DGO ET DGO INOX

DGO

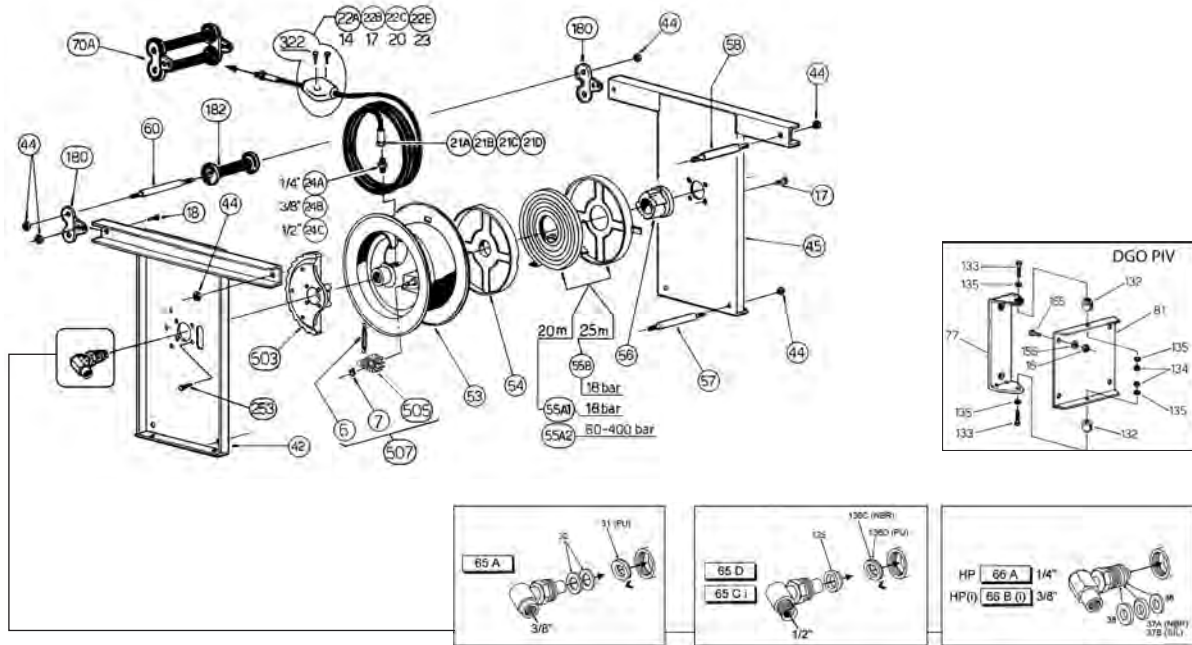

Repère	Référence	Désignation
6	DMG 0006	Ressort de rappel
7	DMG 0007	Circlips Ø 10
16	DMG 0016	Ecrou M10
17	DMG 0017	Vis te M6 x 16
18	DMG 0018	Vis te M6 x 10
21A	DMG 0021A	Jonction pour tube Ø 8
21B	DMG 0021B	Jonction pour tube Ø 10
21C	DMG 0021C	Jonction pour tube Ø 13
21D	DMG 0021D	Jonction pour tube Ø 16
22A	DMO BC14	Butée caoutchouc 8 x 14
22B	DMO BC17	Butée caoutchouc 10 x 17
22C	DGO BC20	Butée caoutchouc 13 x 20
22E	DGO BC23	Butée caoutchouc 16 x 23
24A	DMG 0024A	Mamelon pour tube 8 x 14
24B	DMG 0024B	Mamelon pour tube 10 x 17
24C	DMG 0024C	Mamelon pour tube 13x20 & 16x23
31	DMG 0031	Joint basse pression Ø 12-22
32	DMG 0032	Rondelle d'appui Ø 12-24
36	DMG 0036	Rondelle laiton HP
37A	DMG 0037A	Joint HP 1/4"
37B	DMG 0037B	Joint HP 3/8"
38	DMG 0038	Rondelle d'appui HP
42	DMG 0042	Flanc gauche
44	DMG 0044	Écrou M6
45	DMG 0045	Flanc droit
53	DMG 0053	Tambour
54	DMG 0054	Entretoise pour tambour
55A1	DMG 0055A1	Ressort tube 20m 18 bar
55A2	DMG 0055A2	Ressort tube 20m 60-400 bar
55B	DMG 0055B	Ressort tube 25m
56	DMG 0056	Moyeu d'entraînement
57	DMG 0057	Tirant L : 165mm
58	DMG 0058	Tirant L : 169mm
60	DMG 0060	Tirant L : 173mm
65A	DMG 65A	Raccord complet 3/8"
65D	DMG 0065D	Raccord complet 1/2"
66A	DMG 0066A	Raccord HP 1/4"
66B	DGO 0066B	Raccord HP 3/8"
70A	DMG 0070A	Ensemble guide tuyau
77	DMG 0077	Support
81	DMG 0081	Etrier
125	DMG 0125	Rondelle d'appui Ø 16-24
132	DMG 0132	Bague
133	DMG 0133	Vis M8 x 45
134	DMG 0134	Ecrou M8
135	DMG 0135	Rondelle Ø 8
136D	DMG 0136D	Joint basse pression Ø 16-22
155	DMG 0155	Vis M10 x 20
156	DMG 0156	Rondelle Ø 10
180	DMG 0180	Support rouleaux
182	DMG 0182	Rouleau L=172 mm
253	DMG 0253	Vis te 6 x 21
322	DMG 0322	Vis TC 6 x 20
503	DMG 0503	Conronne dentée
505	DMG 0505	Cliquet
507	DMG 0507	Kit de cliquet

Repère	Référence	Désignation
	DMG TC 0620GR	Tuyau caout. 6 x 16 - 20m
	DMG TC 1020	Tuyau caout. 10 x 17 - 20m
	DMG TC 1025	Tuyau caout. 10 x 17 - 25m
	DMG TC 1315	Tuyau caout. 13 x 20 - 15m
	DMG TC 1315OIL	Tuyau caout. 13 x 20 - 15m
	DMG TC 1320	Tuyau caout. 13 x 20 - 20m
	DMG TC 1320OIL	Tuyau caout. 13 x 20 - 20m
	DMG TC 1610	Tuyau caout. 16 x 23 - 10m
	DMG TC 1610LS	Tuyau caout. 16 x 24 - 10m
	DMG TC 1615LS	Tuyau caout. 16 x 24 - 15m
	DMG HP 0820	Tuyau HP 8 x 17 - 20m
	DGO PIV	Support pivotant

Pièces spécifiques pour DGO INOX		
Repère	Référence	Désignation
6	DMG 0006i	Ressort de rappel cliquet
7	DMG 0007i	Circlips Ø 10
16	DMG 0016i	Écrou M10
17	DMG 0017i	Vis te M6 x 16
18	DMG 0018i	Vis te M6 x 10
24B	DMG 0024Bi	Mamelon pour tube 8x17
24C	DMG 0024Ci	Mamelon pour tube 13x20 & 16x23
42	DMO 0042i	Flanc gauche
44	DMG 0044i	Ecrou M6
45	DMG 0045i	Flanc droit
53	DMG 0053i	Tambour
55A	DMG 0055Ai	Ressort pour tube 20m
57	DMG 0057i	Tirant L : 165mm
58	DMG 0058i	Tirant L : 169mm
60	DMG 0060i	Tirant L : 173mm
65Ci	DMG 0065Ci	Raccord complet 1/2"
66Bi	DMG 66Bi	Raccord complet HP 3/8"
70A	DMG 0070Ai	Ensemble guide tuyau
77	DMG 0077i	Support
81	DMG 0081i	Etrier
132	DMG 0132i	Bague
133	DMG 0133i	Vis M8 x 45
134	DMG 0134i	Ecrou M8
135	DMG 0135i	Rondelle Ø 8
136C	DMG 0136C	Joint basse pression Ø 16-22
155	DMG 0155i	Vis M10x20
156	DMG 0156i	Rondelle Ø10
180	DMG 0180i	Support rouleaux
253i	DMG 0253i	Vis te 6 x 21
507	DMG 0507i	Kit de cliquet

PIÈCES DÉTACHÉES POUR ENROULEURS DLO

DLO

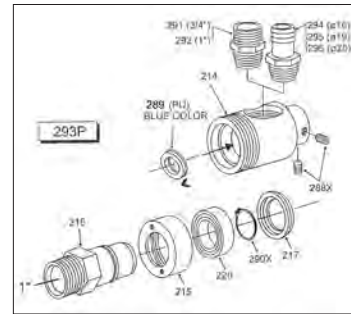
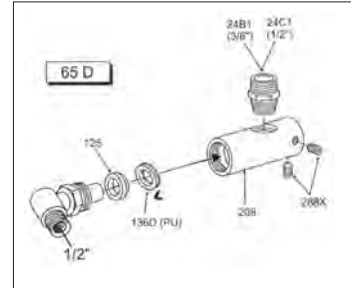
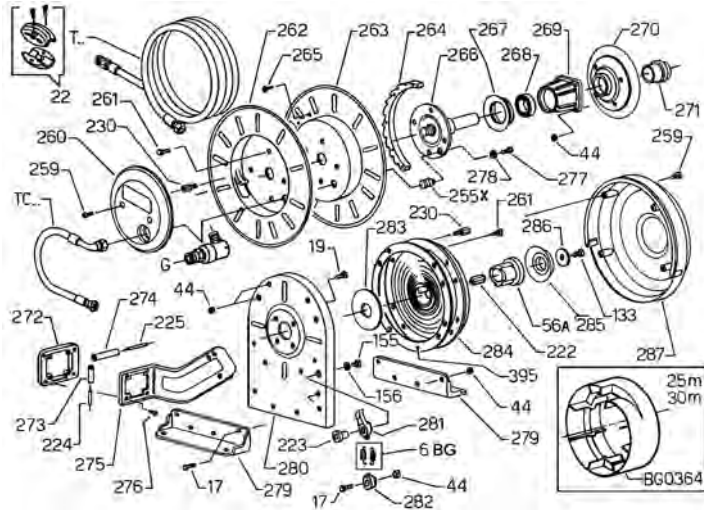

Repère	Référence	Désignation
6	DMG 0006	Ressort de rappel cliquet
17	DMG 0017	Vis te M6 x 16
19	DMG 0019	Vis te M6 x 20
22C	DGO BC20	Butée fin de course 13 x 20
22E	DGO BC23	Butée fin de course 16 X 23
22F	DGO BC27	Butée fin de course 19 X 27
24B1	DMG 0024B1	Union 1/2» - 3/4»
24C1	DMG 0024C1	Union 1/2»
44	DMG 0044	Ecrou M6
56	DMG 0056	Moyeu d'entraînement
	DMG 0065Ci	Raccord tournant Inox
65D	DMG 0065D	Raccord tournant M 1/2»x 16 PU
125	DMG 0125	Rondelle Ø 11 - 24
133	DMG 0133	Vis M8 x 45
136D	DMG 0136D	Joint Ø 16 PU
155	DMG 0155	Vis M10 x 20
156	DMG 0156	Rondelle Ø 10
208	DMG 0208	Moyeu
214	DMG 0214	Corps raccord d. 56
215	DMG 0215	Bague
217	DMG 0217	Rondelle
220	DMG 0220	Rondelle
222	DMG 0222	Insert hexagonal
223	DMG 0223	Pivot de cliquet
224	DMG 0224	Tirant Ø 8 x 53
225	DMG 0225	Tirant Ø 8 x 79
230	DMG 0230	Vis M6 x 18
255	DMG 0255	Tirant Ø 18
259	DMG 0259	Vis TC M6 x 12
260C	DMG 0260	Couvercle centré
260E	DMG 0260	Couvercle excentré
261	DMG 0261	Vis te M6 x 12
262	DMG 0262	Demi-tambour droit
263	DMG 0263	Demi-tambour gauche
264	DMG 0264	Couronne dentée
265	DMG 0265	Vis TS 6 x 18

Repère	Référence	Désignation
266	DMG 0266	Moyeu
267	DMG 0267	Bague
268	DMG 0268	Rondelle
269	DMG 0269	Support
270	DMG 0270	Flasque
271	DMG 0271	Ecrou de verrouillage
272	DMG 0272	Support rouleau
273	DMG 0273	Rouleau L=43
274	DMG 0274	Rouleau L=69
275	DMG 0275	Ensemble guide tuyau
278	DMG 0278	Rondelle Ø 8
280	DMG 0280	Bâti
282	DMG 0282	Ressort
276	DMG 0276	Vis TC 5 x 10
277	DMG 0277	Vis te M8 x 20
279	DMG 0279	Étrier de fixation
281	DMG 0281	Cliquet
283	DMG 0283	Rondelle
284	DMG 0284	Ressort
285	DMG 0285	Bague
286	DMG 0286	Rondelle Ø 8 x 54
287	DMG 0287	Carter ressort
288	DMG 0288	Vis M8 x 16
289	DMG 0289	Joint Ø 28 PU
290	DMG 0290	Circlip 30E
291	DMG 0291	Union 3/4»
292	DMG 0292	Union 3/4» - 1»
293P	DMG 0293P	Raccord tournant pour DLO 19
294	DMG 0294	Jonction Ø 16 x 3/4»
295	DMG 0295	Jonction Ø 19 x 3/4»
395	DMG 0395	Bague D. 350
BG0364	DMG BG0364	Rondelle plastique
T	DMG TC1325	Tuyau caoutchouc Ø 13 x 20 L=25 m
T	DMG TC1620	Tuyau caoutchouc Ø 16 x 23 L=20 m
T	DMG TC1920	Tuyau caoutchouc Ø 19 x 27 L=20 m
TC	DMG TC1920LS	Tuyau de raccordement
TC		Tuyau de raccordement
TC		Tuyau de raccordement

Tubes polyuréthane

FLEXIBILITÉ ET RÉSISTANCE

- ▶ Matière : Polyuréthane Polyester ou Polyamide PA 12
- ▶ Alimentation des composants pneumatiques
- ▶ Souplesse et longévité du tube
- ▶ Excellente mémoire dynamique, reprise de la forme initiale
- ▶ Tenue à la pression et aux températures
- ▶ Antichocs
- ▶ Packaging en boîte dévidoir



& polyamide

	TUBE POLYURÉTHANE PU		TUBE POLYAMIDE PA	
Matière	Polyuréthane base Ester		Polyamide PA 12	
Caractéristiques	<ul style="list-style-type: none"> • Souplesse et longévité • Excellente mémoire, reprise de la forme initiale • Tenue aux huiles et graisses • Résistance à l'abrasion • Stabilité thermique • Ne résiste pas à l'hydrolyse 		<ul style="list-style-type: none"> • Tenue à l'hydrolyse et aux produits chimiques 	
Pression de service à 20°C	Ø ext.	Bar	Ø ext.	Bar
	3 mm	14 Bar	3 mm	27 Bar
	4 mm	10 Bar	4 mm	23 Bar
	5 mm	11 Bar	5 mm	29 Bar
	6 mm	9 Bar	6 mm	27 Bar
	8 mm	8,5 Bar	8 mm	18 Bar
	10 mm	8,5 Bar	10 mm	18 Bar
	12 mm	9 Bar	12 mm	14 Bar
	14 mm	9 Bar	14 mm	12 Bar
	16 mm	9 Bar	16 mm	14 Bar
Température	- 20°C à + 70°C		- 40° C à + 100° C	
Rayon de courbure	selon norme NF		selon norme NF	
Normes	NF : E 49-101		NF E 49-100 DIN 74324-1* DIN 73378	
Diamètre extérieur	3, 4, 5, 6, 8, 10, 12, 14, 16 mm		3, 4, 5, 6, 8, 10, 12, 14, 16 mm	
Couleurs	Bleu, Gris, Incolore, Jaune, Noir, Rouge, Vert		Bleu, Gris, Incolore, Jaune, Noir, Rouge, Vert	
Dureté	52 Shore D		63 Shore D	
Résistance à la traction	40 MPa			
Contrainte à la rupture			50 MPa	
Allongement à la rupture	470 %		300 %	
Contrainte à 100 % d'allongement	16 MPa			
Allongement au seuil			25 %	
Contrainte au seuil			24 MPa	
Résistance à la déchirure	120 N/mm			
Abrasion	35 mm ³			
Comportement au feu	HB UL 94		HB UL 94	
Point Vicat sous 1 daN			160° C	
Température de fléchissement sous charge 0,46 MPa			125° C	
Conditionnement	Boîte dévidoir de 25 mètres Touret de 100 mètres		Boîte dévidoir de 25 mètres Touret de 100 mètres	
Repérage	Tous les 50 cm		Tous les 50 cm	
Marquage (Matière, Ø, pression)	Tous les 50 cm		Tous les 50 cm	

* Tube polyamide pour systèmes de freinage

DIN 74324-1

pour Ø 4 x 6 mm
Ø 6 x 8 mm
Ø 7,5 x 10 mm
Ø 8 x 10 mm
Ø 9 x 12 mm

Tube polyamide pour utilisation dans les véhicules à moteur

DIN 73378

A CHAQUE UTILISATION SON TUYAU

Diversité de conceptions et de matières en fonction de l'application





AIRCA

Tuyau caoutchouc

- Tuyau caoutchouc avec bandes bleues et noires alternées
- Tube intérieur en SBR.
- Tresse textile synthétique
- Robe extérieure en SBR/EPDM (résistance aux UV et à l'ozone)
- Résistance aux efforts de flexion, traction et torsion
- Excellente tenue aux frottements sur sol béton

► **Applications** : alimentation en air lubrifié pour outillage pneumatique.



VALYFLEX

Tuyau polyuréthane gainé PVC

- Tuyau : couche interne polyuréthane, couche externe PVC
- Excellente résistance à l'abrasion et très grande flexibilité

► **Applications** : air comprimé, transfert d'essences, huiles, fuels, solvants, pulvérisation agricole, passage de produits moyennement abrasifs (poudres et grains).

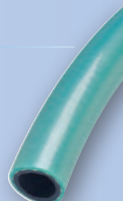

STOFLEX

Tuyau caoutchouc antistatique

- Conductivité électrique : résistance électrique < 106 ohm/m.
- Tube intérieur : EPDM noir lisse
- Armature : fils synthétiques
- Tube extérieur : EPDM bleu lisse

► **Applications** : alimentation en air comprimé, pistolets de peinture, cabines de peinture.



LOCKFLEX

Tuyau auto-serreur NBR / PVC

- Ne nécessite pas l'utilisation de colliers
- Adapté aux jonctions type AF, aux prises et fiches rapides type CPI
- Existe en bleu et en rouge

► **Applications** : circuits de refroidissement des moules.



DIFLEX

Tuyau PVC

- Tuyau transparent PVC renforcé par une tresse de nylon
- Compatible avec une large gamme de produits chimiques

► **Applications** : air comprimé, eau.

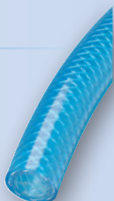

DOLEX

Tuyau caoutchouc industriel

- Qualité alimentaire
- Intérieur NBR
- Armature fils synthétiques et revêtement NBR/PVC

► **Applications** : lavage des sols et nettoyage à l'eau chaude dans les industries agro-alimentaires, les conserveries, les laiteries, les abattoirs.



SURFLEX

Tuyau PVC avec armature

- Tuyau 3 couches thermoplastiques.
- Léger, souple, résistant aux chocs et à l'écrasement.

► **Applications** : alimentation de l'outillage pneumatique.



HOFLEX

Tuyau PVC

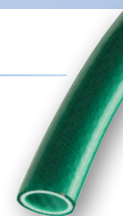

- Maille textile PVC anti-torsion
- Revêtement PVC protection "écran total"

► **Applications** : lavage et nettoyage à l'eau, arrosage.





TUBES POLYURETHANE

Souplesse et longévité	Température -20°C à +70°C	Matière Polyuréthane Base Ester	Alimentation composants d'automatisme	Résistance aux huiles et aux graisses	Norme NFE 49-101	Dureté 52 Shore D
------------------------	---------------------------	---------------------------------	---------------------------------------	---------------------------------------	------------------	-------------------

		A	B	Couleur	Diamètre int./ext mm	Pression Service à 20°C - bar	Couronne m	Mini de courbure mm	REFERENCE
Tube polyuréthane en boîte dévidoir de 25 mètres (unité de vente = 1 boîte)									
  				Noir	1,8 x 3	14	25	10	PUBK M180325
				Noir	2,5 x 4	10	25	12	PUBK M250425
				Bleu	2,5 x 4	10	25	12	PUBE M250425
				Incolore	2,5 x 4	10	25	12	PUCR M250425
				Vert	2,5 x 4	10	25	12	PUGN M250425
				Jaune	2,5 x 4	10	25	12	PUYW M250425
				Gris	2,5 x 4	10	25	12	PUGY M250425
				Rouge	2,5 x 4	10	25	12	PURD M250425
				Noir	3 x 5	11	25	13	PUBK M030525
				Bleu	3 x 5	11	25	13	PUBE M030525
				Noir	4 x 6	9	25	15	PUBK M040625
				Bleu	4 x 6	9	25	15	PUBE M040625
				Incolore	4 x 6	9	25	15	PUCR M040625
				Vert	4 x 6	9	25	15	PUGN M040625
				Jaune	4 x 6	9	25	15	PUYW M040625
				Gris	4 x 6	9	25	15	PUGY M040625
				Rouge	4 x 6	9	25	15	PURD M040625
				Noir	5,5 x 8	8,5	25	20	PUBK M550825
				Bleu	5,5 x 8	8,5	25	20	PUBE M550825
				Transparent	5,5 x 8	8,5	25	20	PUCR M550825
				Vert	5,5 x 8	8,5	25	20	PUGN M550825
				Jaune	5,5 x 8	8,5	25	20	PUYW M550825
				Gris	5,5 x 8	8,5	25	20	PUGY M550825
				Rouge	5,5 x 8	8,5	25	20	PURD M550825
				Noir	7 x 10	8,5	25	25	PUBK M071025
				Bleu	7 x 10	8,5	25	25	PUBE M071025
				Incolore	7 x 10	8,5	25	25	PUCR M071025
				Vert	7 x 10	8,5	25	25	PUGN M071025
				Jaune	7 x 10	8,5	25	25	PUYW M071025
				Gris	7 x 10	8,5	25	25	PUGY M071025
			Rouge	7 x 10	8,5	25	25	PURD M071025	
			Noir	8 x 12	9	25	35	PUBK M081225	
			Bleu	8 x 12	9	25	35	PUBE M081225	
			Incolore	8 x 12	9	25	35	PUCR M081225	
			Noir	9,5 x 14	9	25	45	PUBK M951425	
			Bleu	9,5 x 14	9	25	45	PUBE M951425	
			Incolore	9,5 x 14	9	25	45	PUCR M951425	
			Noir	11 x 16	9	25	55	PUBK M111625	



TUBES POLYURETHANE

Souplesse et longévité	Température - 20°C à +70°C	Matière Polyuréthane Base Ester	Alimentation composants d'automatisme	Résistance aux huiles et aux graisses	Norme NF E 49-101	Dureté 52 Shore D
------------------------	----------------------------	---------------------------------	---------------------------------------	---------------------------------------	-------------------	-------------------

		A	B	Couleur	Diamètre int./ext mm	Pression Service à 20°C - bar	Couronne m	Mini de courbure mm	REFERENCE
Tube polyuréthane en touret de 100 mètres (unité de vente = 1 touret)									
 <p>PU</p>				Noir	2,5 x 4	10	100	12	PUBK M2504100
				Bleu	2,5 x 4	10	100	12	PUBE M2504100
				Incolore	2,5 x 4	10	100	12	PUCR M2504100
				Vert	2,5 x 4	10	100	12	PUGN M2504100
				Jaune	2,5 x 4	10	100	12	PUYW M2504100
				Gris	2,5 x 4	10	100	12	PUGY M2504100
				Rouge	2,5 x 4	10	100	12	PURD M2504100
				Noir	4 x 6	9	100	15	PUBK M0406100
				Bleu	4 x 6	9	100	15	PUBE M0406100
				Incolore	4 x 6	9	100	15	PUCR M0406100
				Vert	4 x 6	9	100	15	PUGN M0406100
				Jaune	4 x 6	9	100	15	PUYW M0406100
				Gris	4 x 6	9	100	15	PUGY M0406100
				Rouge	4 x 6	9	100	15	PURD M0406100
				Noir	5,5 x 8	8,5	100	20	PUBK M5508100
				Bleu	5,5 x 8	8,5	100	20	PUBE M5508100
				Incolore	5,5 x 8	8,5	100	20	PUCR M5508100
				Vert	5,5 x 8	8,5	100	20	PUGN M5508100
				Jaune	5,5 x 8	8,5	100	20	PUYW M5508100
				Gris	5,5 x 8	8,5	100	20	PUGY M5508100
				Rouge	5,5 x 8	8,5	100	20	PURD M5508100
				Noir	7 x 10	8,5	100	25	PUBK M0710100
				Bleu	7 x 10	8,5	100	25	PUBE M0710100
				Incolore	7 x 10	8,5	100	25	PUCR M0710100
			Noir	8 x 12	9	100	35	PUBK M0812100	
			Bleu	8 x 12	9	100	35	PUBE M0812100	
			Incolore	8 x 12	9	100	35	PUCR M0812100	
			Noir	9,5 x 14	9	100	45	PUBK M9514100	
Coupe tube - R22 CT									
 			Spécialement conçu pour obtenir une coupe parfaite à 90°.						
	112	28							R22 CT

TUBES POLYAMIDE

Température - 40°C à + 100°C	Excellente mémoire de forme	Matière Polyamide PA 12	Alimen- tation composants d'automatismes	Dureté 63 Shore D	Norme NF E 49-100 DIN 73378 - 74324
---------------------------------	--------------------------------	----------------------------	--	----------------------	---

		A	B	Couleur	Diamètre int./ ext. mm	Pression Service à 20°C - bar	Couronne m	Mini de courbure mm	REFERENCE
Tube Polyamide en boîte dévidoir de 25 m (Unité de vente = 1 boîte)									
  				Noir	1,8 x 3	27	25	15	PABK M180325
				Bleu	1,8 x 3	27	25	15	PABE M180325
				Noir	2,7 x 4	23	25	30	PABK M270425
				Bleu	2,7 x 4	23	25	30	PABE M270425
				Incolore	2,7 x 4	23	25	30	PACR M270425
				Vert	2,7 x 4	23	25	30	PAGN M270425
				Jaune	2,7 x 4	23	25	30	PAYW M270425
				Gris	2,7 x 4	23	25	30	PAGY M270425
				Rouge	2,7 x 4	23	25	30	PARD M270425
				Noir	3 x 5	29	25	30	PABK M030525
				Bleu	3 x 5	29	25	30	PABE M030525
				Incolore	3 x 5	29	25	30	PACR M030525
				Noir	4 x 6	27	25	35	PABK M040625
				Bleu	4 x 6	27	25	35	PABE M040625
				Incolore	4 x 6	27	25	35	PACR M040625
				Vert	4 x 6	27	25	35	PAGN M040625
				Jaune	4 x 6	27	25	35	PAYW M040625
				Gris	4 x 6	27	25	35	PAGY M040625
				Rouge	4 x 6	27	25	35	PARD M040625
				Noir	6 x 8	18	25	55	PABK M060825
				Bleu	6 x 8	18	25	55	PABE M060825
				Incolore	6 x 8	18	25	55	PACR M060825
				Vert	6 x 8	18	25	55	PAGN M060825
				Jaune	6 x 8	18	25	55	PAYW M060825
				Gris	6 x 8	18	25	55	PAGY M060825
				Rouge	6 x 8	18	25	55	PARD M060825
				Noir	7,5 x 10	19	25	75	PABK M751025
				Incolore	7,5 x 10	19	25	75	PACR M751025
				Noir	8 x 10	18	25	90	PABK M081025
				Bleu	8 x 10	18	25	90	PABE M081025
			Incolore	8 x 10	18	25	90	PACR M081025	
			Vert	8 x 10	18	25	90	PAGN M081025	
			Jaune	8 x 10	18	25	90	PAYW M081025	
			Gris	8 x 10	18	25	90	PAGY M081025	
			Rouge	8 x 10	18	25	90	PARD M081025	
			Noir	9 x 12	19	25	75	PABK M091225	
			Incolore	9 x 12	19	25	75	PACR M091225	
			Noir	10 x 12	14	25	92	PABK M101225	
			Bleu	10 x 12	14	25	92	PABE M101225	
			Incolore	10 x 12	14	25	92	PACR M101225	
			Noir	12 x 14	12	25	120	PABK M121425	
			Bleu	12 x 14	12	25	120	PABE M121425	
			Incolore	12 x 14	12	25	120	PACR M121425	
			Incolore	13 x 16	14	25	115	PACR M131625	



TUBES POLYAMIDE

Température - 40°C à + 100°C	Excellente mémoire de forme	Matière Polyamide PA 12	Alimen- tation composants d'automatismes	Dureté 63 Shore D	Norme NF E 49-100 DIN 73378 - 74324
---------------------------------	--------------------------------	----------------------------	--	----------------------	---







		A	B	Couleur	Diamètre int./ ext. mm	Pression Service à 20°C - bar	Couronne m	Mini de courbure mm	REFERENCE	
Tube Polyamide en touret de 100 mètres (Unité de vente = 1 touret)										
				Noir	2,7 x 4	23	100	30	PABK M2704100	
				Bleu	2,7 x 4	23	100	30	PABE M2704100	
				Incolore	2,7 x 4	23	100	30	PACR M2704100	
				Vert	2,7 x 4	23	100	30	PAGN M2704100	
				Jaune	2,7 x 4	23	100	30	PAYW M2704100	
				Gris	2,7 x 4	23	100	30	PAGY M2704100	
				Rouge	2,7 x 4	23	100	30	PARD M2704100	
				Noir	4 x 6	27	100	100	35	PABK M0406100
				Bleu	4 x 6	27	100	100	35	PABE M0406100
				Incolore	4 x 6	27	100	100	35	PACR M0406100
				Vert	4 x 6	27	100	100	35	PAGN M0406100
				Jaune	4 x 6	27	100	100	35	PAYW M0406100
				Gris	4 x 6	27	100	100	35	PAGY M0406100
				Rouge	4 x 6	27	100	100	35	PARD M0406100
				Noir	6 x 8	18	100	100	55	PABK M0608100
				Bleu	6 x 8	18	100	100	55	PABE M0608100
				Incolore	6 x 8	18	100	100	55	PACR M0608100
				Vert	6 x 8	18	100	100	55	PAGN M0608100
				Jaune	6 x 8	18	100	100	55	PAYW M0608100
				Gris	6 x 8	18	100	100	55	PAGY M0608100
				Rouge	6 x 8	18	100	100	55	PARD M0608100
				Noir	7,5 x 10	19	100	100	75	PABK M7510100
				Incolore	7,5 x 10	19	100	100	75	PACR M7510100
				Noir	8 x 10	18	100	100	90	PABK M0810100
				Bleu	8 x 10	18	100	100	90	PABE M0810100
				Incolore	8 x 10	18	100	100	90	PACR M0810100
				Vert	8 x 10	18	100	100	90	PAGN M0810100
				Jaune	8 x 10	18	100	100	90	PAYW M0810100
				Gris	8 x 10	18	100	100	90	PAGY M0810100
				Rouge	8 x 10	18	100	100	90	PARD M0810100
			Noir	9 x 12	19	100	100	75	PABK M0912100	
			Incolore	9 x 12	19	100	100	75	PACR M0912100	
			Noir	10 x 12	14	100	100	92	PABK M1012100	
			Bleu	10 x 12	14	100	100	92	PABE M1012100	
			Incolore	10 x 12	14	100	100	92	PACR M1012100	
			Rouge	12 x 14	12	100	100	120	PARD M1214100	

Coupe tube - R22 CT										
				Spécialement conçu pour obtenir une coupe parfaite à 90°.						
	112	28							R22 CT	



TUYAUX EN COURONNE

Longévité	Résistance à l'abrasion	Souplesse et flexibilité	Conditionnement en couronne	Matière PVC - SBR/EPDM - PU				
		Couronne m	Couleur	Diamètre int./ext en mm	Pression Utilisation à 20°C - bar	Température Maxi °C	Pression Max. 20°C - bar	REFERENCE
Tuyau PVC Diflex - en couronne								
		50	Bleu	6 x 12	15	60	50	DIFLEX 6
		50	Bleu	8 x 14	15	60	50	DIFLEX 8
		50	Rouge	8 x 14	15	60	50	DIFLEX 8RG
		25	Bleu	8 x 14	15	60	50	DIFLEX 8C25
		50	Bleu	9 x 15	15	60	50	DIFLEX 9
		50	Bleu	10 x 16	15	60	50	DIFLEX 10
		50	Rouge	10 x 16	15	60	50	DIFLEX 10RG
		25	Bleu	10 x 16	15	60	50	DIFLEX 10C25
		50	Bleu	12 x 19	15	60	50	DIFLEX 12
		50	Rouge	12 x 19	15	60	50	DIFLEX 12RG
		50	Bleu	13 x 20	15	60	50	DIFLEX 13
		50	Rouge	13 x 20	15	60	50	DIFLEX 13RG
		25	Bleu	16 x 22	10	60	50	DIFLEX 16
		25	Bleu	19 x 26	10	60	50	DIFLEX 19
		25	Bleu	25 x 33	10	60	50	DIFLEX 25
	25	Incolore	32 x 41	11	60	35	DIFLEX 32	
	25	Incolore	38 x 47	10	60	30	DIFLEX 38	
	25	Incolore	50 x 60	8	60	22	DIFLEX 50	
Tuyau caoutchouc Airca - en couronne								
		40	Bleu - Noir	6 x 13	20	70	60	AIRCA 6
		40	Bleu - Noir	8 x 15	20	70	60	AIRCA 8
		20	Bleu - Noir	8 X 15	20	70	60	AIRCA 8C20
		40	Bleu - Noir	10 x 18	20	70	60	AIRCA 10
		40	Bleu - Noir	13 x 22	20	70	60	AIRCA 13
		40	Bleu - Noir	16 x 25	15	70	50	AIRCA 16
		40	Bleu - Noir	19 x 28	15	70	50	AIRCA 19
		40	Bleu - Noir	25 x 35	15	70	50	AIRCA 25
Tuyau gainé PVC surflex - en couronne								
		50	Bleu	6.3 x 11	20	60	60	SURFLEX 6
		30	Bleu	6.3 x 11	20	60	60	SURFLEX 6C30
		50	Bleu	8 x 13	20	60	60	SURFLEX 8
		30	Bleu	8 x 13	20	60	60	SURFLEX 8C30
		50	Bleu	9 x 14.5	20	60	60	SURFLEX 9
		30	Bleu	9 x 14.5	20	60	60	SURFLEX 9C30
		50	Bleu	10 x 15.5	20	60	60	SURFLEX 10
		30	Bleu	10 x 15.5	20	60	60	SURFLEX 10C30
		50	Bleu	12,7 x 19	20	60	60	SURFLEX 13
		30	Bleu	12.7 x 19	20	60	60	SURFLEX 13C30



TUYAUX EN COURONNE

Longévité	Résistance à l'abrasion	Souplesse et flexibilité		Conditionnement en couronne			Matière PVC - SBR/EPDM - PU	
		Couronne m	Couleur	Diamètre int./ext en mm	Pression Utilisation à 20°C - bar	Température Maxi °C	Pression Max. 20°C - bar	REFERENCE
Tuyau antistatique Stoflex - en couronne								
		50	Bleu	8 X 15	20	100	50	STOFLEX 8
		50	Bleu	9 x 16	20	100	50	STOFLEX 9
		50	Bleu	10 X 18	20	100	50	STOFLEX 10
Tuyau polyuréthane Valyflex - en couronne								
		30	Vert	8 x 14	20	60	60	VALYFLEX 8
		30	Vert	10 x 16	20	60	60	VALYFLEX 10
		30	Vert	12.7 x 19	20	60	60	VALYFLEX 13
Tuyau auto serreur Lockflex NBR/PVC - en couronne								
		Pour montage sans collier sur jonction AF						
		20	Bleu	10 x 17.5	10	-25 °C +70 °C	40	LOCKFLEX 10BL
		20	Rouge	10 x 17.5	10	-25 °C +70 °C	40	LOCKFLEX 10RG
		20	Bleu	13 x 20.4	10	-25 °C +70 °C	40	LOCKFLEX 13BL
	20	Rouge	13 x 20.4	10	-25 °C +70 °C	40	LOCKFLEX 13RG	
Tuyau polyuréthane Enroulex (spécial enrouleurs)								
		120	Noir	8 x 12	20	65	60	ENROULEX 8
		90	Bleu	10 x 14	20	65	60	ENROULEX 10
Tuyau caoutchouc industriel - Qualité alimentaire								
		20	Bleu	15,8 x 24	10	- 20 + 95		DOLEX 15
		20	Bleu	19,4 x 28,4	10	- 20 + 95		DOLEX 19
Tuyau PVC anti-torsion Hoflex								
		25	Vert	15 x 21	13	- 20 + 60		HOFLEX 15
		25	Vert	19 x 26	13	- 20 + 60		HOFLEX 19

SUPPORT DE TUYAUX

		A	B	C	D	DESIGNATION	REFERENCE
Support de tuyau Inox 304							
		355	210	160	160	Support fixation murale Rangement de 25 m de tuyau	EHS 25

TUYAUX DE SOUDURE OXYGENE ACETYLENE

		Diamètre mm	Gaz	REFERENCE
Tuyau de soudage en couronne (20 m)				
		Tuyau simple conduit Longueur du rouleau : 20 m Pression d'utilisation à 20°C : 20 bar Pression de rupture à 20 °C : 60 bar Température maxi d'utilisation : + 60°C		
		6 x 12	Oxygène	TUB OX6
		6 x 12	Acétylène	TUB SET6
		10 x 17	Oxygène	TUB OX10
		10 x 17	Acétylène	TUB SET10
Tuyau double conduit désolidarisable (20 m)				
		Tuyau double conduit désolidarisable Oxygène et Acétylène Longueur du rouleau : 20 m Pression d'utilisation à 20°C : 20 bar Pression de rupture à 20 °C : 60 bar Température maxi d'utilisation : + 60°C		
		6 x 12	Oxy. + Acét.	TUB OA6
		10 x 17	Oxy. + Acét.	TUB OA10

rallonges

RALLONGES DE TUYAU ÉQUIPÉES D'UN RACCORD RAPIDE ET D'UN EMBOUT

- ▶ Large gamme de rallonges : choix du type de tuyau, du diamètre et de la longueur
- ▶ Montage de raccords parfaitement adaptés au diamètre du tuyau
- ▶ Montage étanches, prêts à l'emploi
- ▶ Branchements faciles et sûrs
- ▶ Simplicité d'utilisation, de déplacement, de rangement



RALLONGES DE TUYAU SERTIES

- Branchement tuyau / raccord assuré par un sertissage industriel
- Jupe enveloppante en acier
- Excellent maintien du tuyau



RALLONGES DE TUYAU AVEC RACCORD ORIENTABLE

- Rallonges de tuyau air comprimé spéciales pistolets de peinture montées avec tuyau antistatique STOFLEX
- Rallonges de tuyau air comprimé spéciales outils pneumatiques, montées avec tuyau caoutchouc SBR avec tresse textile AIRCA



Les rallonges avec raccords à rotule suppriment :

- les problèmes d'entortillement des tuyaux
- les interruptions de travail dues aux cassures des tuyaux
- les difficultés et les positions inconfortables
- la fatigue du bras et du poignet

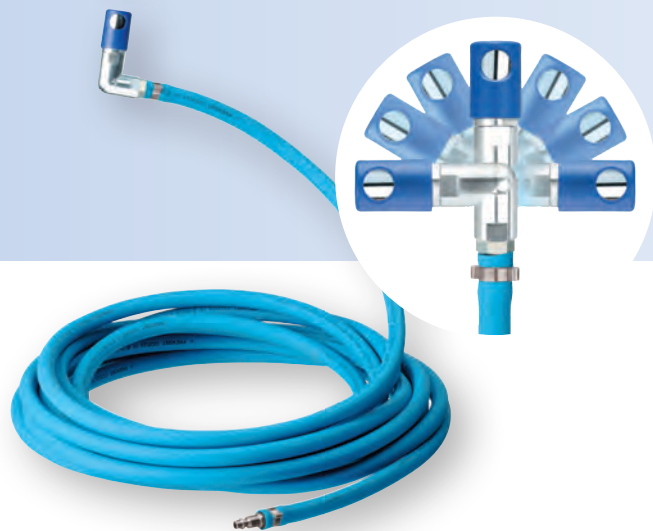
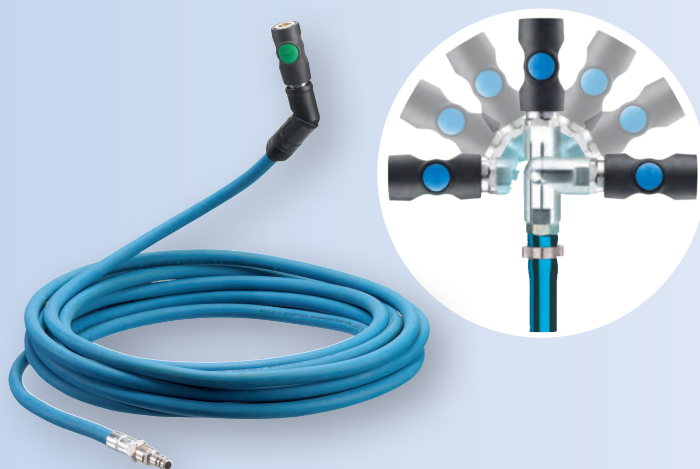
Elles offrent à l'opérateur la liberté de mouvement nécessaire à un travail rapide et de qualité.







RALLONGES DE TUYAU SERTI EQUIPEES DE RACCORDS RAPIDES

Economique	Equipé Raccord et embout	Matière SBR - EPDM	Prêt à l'emploi	Equipé monté étanche		
Diamètre int./ext. en mm	Equipé d'un raccord Rapide	Longueur m	Pression Utilisation à 20°C	Température Maxi. °C	Equipé d'un embout	REFERENCE
Rallonges serties en caoutchouc EPDM antistatique Stoflex avec protecteur anti-rayure						
	8 x 15	ISI 06	10	12	+60	RST SISB810
	8 x 15	IRC 06	10	12	+60	RST SIRCB810
	8 x 15	CSI 06	10	12	+60	RST SCSB810
	8 x 15	ESI 07	10	12	+60	RST SESB810
	8 x 15	ERC 07	10	12	+60	RST SERCB810
	9 x 16	ISI 06	12.50	12	+60	RST SISB912
	9 X 16	ESI 07	10	12	+60	RST SESB910
	9 x 16	ERC 07	10	12	+60	RST SERCB910
	10 x 18	IRC 06	10	12	+60	RST SIRCB1010
	10 x 18	ESI 07	10	12	+60	RST SESB1010
	10 X 18	ERC 07	10	12	+60	RST SERCB1010
10 X 18	ESI 07	12,5	12	+60	RST SESB1012	
Rallonges caoutchouc SBR / EPDM Airca avec raccords rapides						
	8 x 15	IRC 06	10	12	+60	RST AIRC810
	8 x 15	IRM 06	10	16	+60	RST AIRM810
	8 x 15	CSI 06	10	12	+60	RST ACS810
	10 x 18	ISI 06	10	12	+60	RST AIS1010
	10 x 18	ISI 08	10	12	+60	RST AIS81010
13 x 22	ISI 08	10	12	+60	RST AIS1310	



RALLONGES DE TUYAU AVEC RACCORDS RAPIDES

Matière PVC - PU - SBR - EPDM	Prêt à l'emploi	Economique	Equipé Raccord et embout	Equipé monté étanche		
Diamètre int./ext. en mm	Equipé d'un raccord rapide	Longueur m	Pression Utilisation à 20°C	Température Maxi. °C	Equipé d'un embout	REFERENCE
Rallonges PVC Diflex						
	8x14	ISI 06	10	12	+60	RAL 810DIS
	8x14	IRC 06	10	12	+60	RAL 810DIRC
	8x14	IRM 06	10	16	+60	RAL 810D
	8x14	CSI 06	10	12	+60	RAL DCS810
	10x16	ISI 08	10	12	+60	RAL 1010DIS

RALLONGES DE TUYAU AVEC RACCORDS RAPIDES

Matière PVC - PU - SBR - EPDM		Prêt à l'emploi		Economique		Equipé Raccord et embout		Equipé monté étanche	
		Diamètre int./ext. en mm	Equipé d'un raccord rapide	Longueur m	Pression Utilisation à 20°C	Température Max.°C	Equipé d'un embout	REFERENCE	
Rallonges caoutchouc EPDM antistatique Stoflex Anti rayure									
	8 x 15	IRC 06	12.50	12	+60	IRP 06	RAL 8125SIB		
	8 x 15	CSI 06	12.50	12	+60	CRP 06	RAL SCSB812		
	8 x 15	ISI 06	12.50	12	+60	IRP 06	RAL SISB8125		
	10 x 18	ISI 06	12.50	12	+60	IRP 06	RAL SISB10125		
	10 x 18	IRC 06	12.50	12	+60	IRP 06	RAL 10125SIB		
Rallonges caoutchouc SBR / EPDM Airca									
	8 x 15	ISI 06	10	12	+70	IRP 06	RAL AIS810		
	8 x 15	IRC 06	10	12	+70	IRP 06	RAL 810IRC		
	8 x 15	CSI 06	10	12	+70	CRP 06	RAL ACS810		
	8 x 15	CSM 06	10	12	+70	CRP 06	RAL ACM6810		
	16 x 25	2 ISG 11: 1xISG 111816 1xISG 111103	20	12	+70	3 IRP: 2xIRP 116153 1xIRP 116816	LHD A1620		
Rallonges PVC surflex									
	8 x 13	IRM 06	12.5	16	+60	IRP 06	RAL 8125X		
	8 x 13	ISI 06	12.5	12	+60	IRP 06	RAL 8125XIS		
	10 x 15.5	IRC 06	10	12	+60	IRP 06	RAL 1010SIRC		
	8 x 13	CSI 06	12.5	12	+60	CRP 06	RAL XCS812		
Rallonges Polyuréthane gainé PVC Valyflex									
	8 x 14	ISI 06	15	12	+60	IRP 06	ERK 4IS		
	8 x 14	IRM 06	15	16	+60	IRP 06	ERK 4		
	8 x 14	ISC 06	10	12	+60	IRP 06	RAL 810VIRC		
	8 x 14	CSI 06	10	12	+60	CRP 06	RAL VCS810		
	10 x 16	ISC 08	10	12	+60	IRP 08	ERK 5		
	10 x 16	ISI 08	10	12	+60	IRP 08	ERK 5IS		
	12.7 x 19	IRC 08	7.5	12	+60	IRP 08	ERK 6		

RALLONGES DE TUYAU AVEC RACCORDS A ROTULE

Matière Caoutchouc SBR et antistatique		Equipé Raccord - Embout		Orientable 360°		Prêt à l'emploi		Equipé monté étanche	
		Diamètre int/ext mm	Equipé d'un raccord rapide	Longueur m	Profil du raccord	Pression 20°C	Température Max. °C	Equipé d'un embout	REFERENCE
Rallonges de tuyau AIRCA pour outils pneumatiques									
	8 x 15	ISC 06	10	ISO 6150B	12	+70	IRP 06	RST AISCW810	
	10 x 18	ISC 06	10	ISO 6150B	12	+70	IRP 06	RST AISCW1010	
	13 x 22	ISC 08	10	ISO 6150B	12	+70	IRP 08	RST AISCW81310	
	10 x 18	CSI 06	10	ISO 6150C	12	+70	CRP 06	RST ACSW1010	
Rallonges de tuyau antistatique STOFLEX pour pistolets de peinture									
	8 x 15	ESI 07	10	7,2-7,4	12	+70	ERP 07	RST SESW810	
	9 x 16	ESI 07	10	7,2 - 7,4	12	+70	ERP 07	RST SESW910	
	10 x 18	ESI 07	10	7,2 - 7,4	12	+70	ERP 07	RST SESW1010	
	10 x 18	ESI 07	12,5	7,2 - 7,4	12	+70	ERP 07	RST SESW1012	
	8 x 15	ISI 06	10	ISO 6150B	12	+70	IRP 06	RST SISW810	
	8 x 15	IRC 06	10	ISO 6150B	12	+70	IRP 06	RST SIRCW810	
	10 x 18	IRC 06	10	ISO 6150B	12	+70	IRP 06	RST SIRCW1010	



MANCHETTES DE LIAISON

Equipé Embout et jonction		Matière SBR - EPDM		Prêt à l'emploi		Equipé monté étanche		
		Longueur m	Diamètre int./ext. en mm	Filetage	Equipé d'un embout	Pression Utilisation à 20°C - bar	Température Maxi °C	REFERENCE
Manchettes de liaison								
	- Absorption des vibrations néfastes aux raccords rapides - Réalisation de liaisons - Pour enrouleurs non équipés de flexibles d'arrivée d'air							
	0,4	10 x 18	G 1/4	IRP 06	12	70	MAI 061410	
	0,4	10 x 18	G 1/4	CRP 06	12	70	MAC 061410	
	0,4	10 x 18	G 1/4	ERP 07	12	70	MAE 071410	
	0,4	10 x 18	G 1/2	IRP 06	12	70	MAI 061210	
	0,4	13 x 22	G 3/8	IRP 08	12	70	MAI 083813	
	0,4	13 x 22	G 3/8	CRP 08	12	70	MAC 083813	
	0,4	13 x 22	G 3/8	ERP 07	12	70	MAE 073813	
	0,4	13 x 22	G 1/2	IRP 08	12	70	MAI 081213	
	0,4	16 x 25	G 1/2	IRP 11	12	70	MAI 111216	
	0,4	16 x 25	G 3/4	IRP 11	12	70	MAI 113416	

RALLONGES DE TUYAU AVEC RACCORDS EAU

Equipé de raccord et embout pour eau	Souple et résistant	Matière PVC	Utilisation Lavage et nettoyage	Prêt à l'emploi Montage étanche				
		Couronne	Couleur	Diamètre int./ext. en mm	Pression en bar	Température en °C	Matière	REFERENCE
Rallonge de tuyau équipée d'un raccord à obturation et d'un embout								
		Tuyau PVC anti-vrille, couleur jaune Equipée de raccords ELS 091815 et ELP 096815						
		25 m	Jaune	15 x 21	8	- 10 + 50	PVC anti-vrille	RAL 1525TLS

RALLONGES DE TUYAUX DE SOUDURE

Equipé monté étanche	Application soudure	Fluide Oxygène Acétylène	Sécurité	
		Entrée	Sortie	REFERENCE
Rallonge soudure complète à visser sur détendeur montée étanche				
		Fonctions : anti retour de flamme et anti retour de gaz Raccordement rapide		
		Protection du soudeur comprenant: 2 jonctions, 10 m de tuyau soudure jumelée, 2 raccords sécurité, 4 colliers à oreilles conditionnement : emballage carton		
		10 x 150	6 x 12	SIR 06S2
		10 x 150	10 x 17	SIR 10S2
Manchette soudure complète à visser sur chalumeau monté étanche				
		Fonction raccordement rapide comprenant : 2 jonctions, 0,8 m de tuyau soudure jumelée, 2 raccords sécurité, 4 colliers à oreilles		
		6 x 12	16 x 150	SIM 06
		6 x 12	12 x 100	SIM 0612
		10 x 17	16 x 150	SIM 10

spirales

TUYAUX SPIRALÉS AVEC RACCORD ROTATIF : LA LIBERTÉ DE MOUVEMENT ASSURÉE

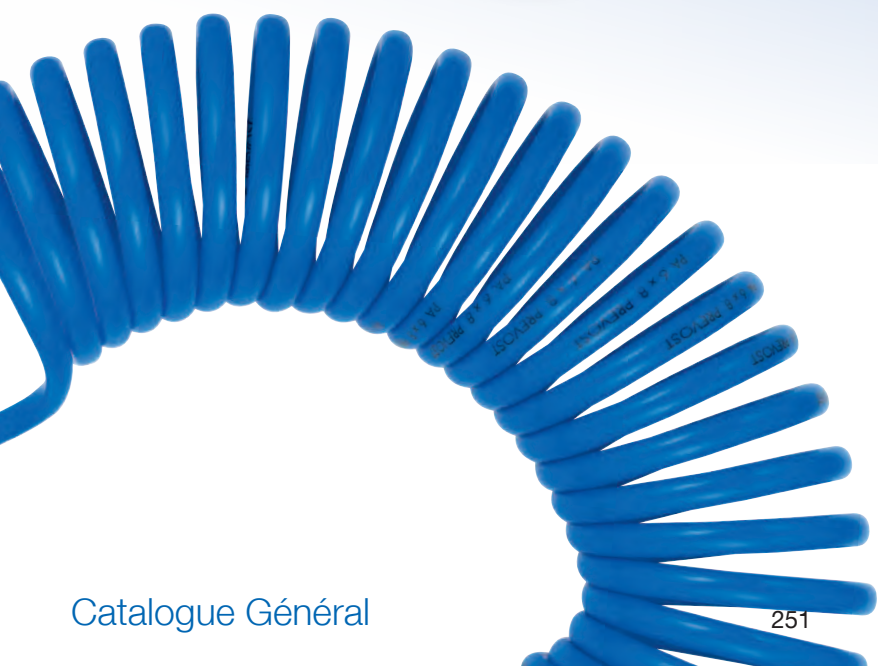
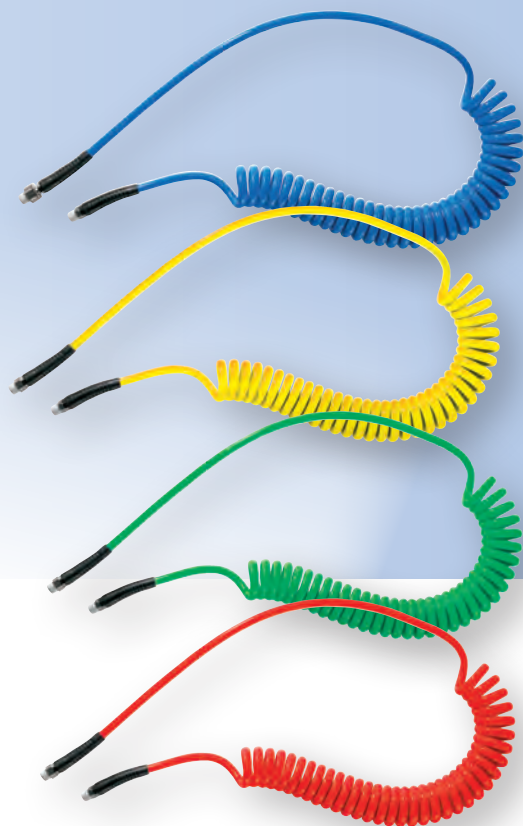
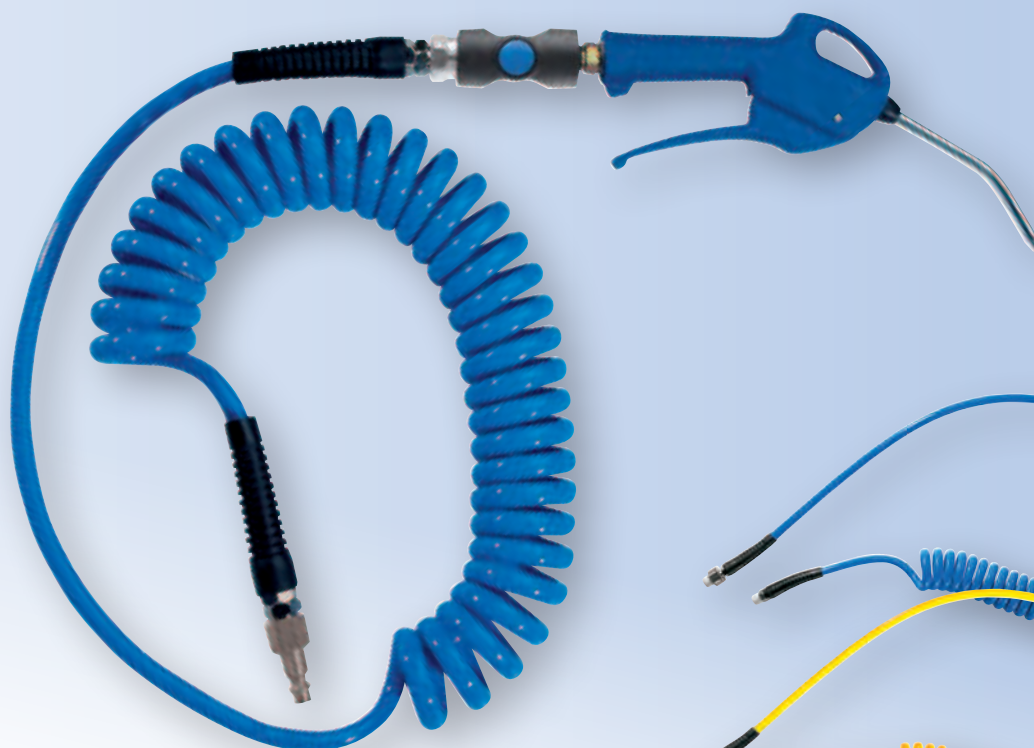

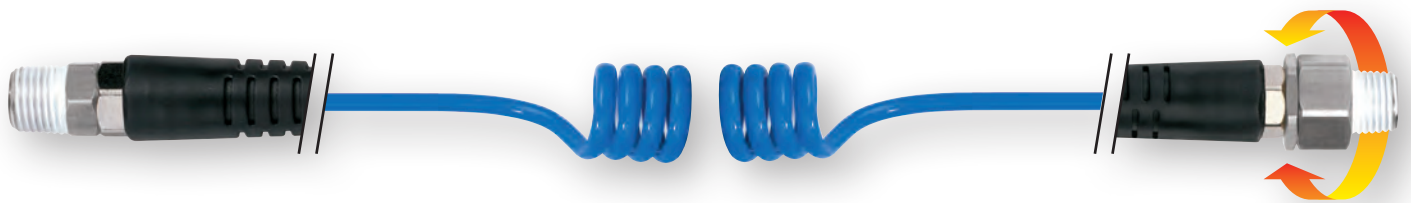

TUYAU SPIRALÉ POLYURÉTHANE PUS

SOUPLESSE ET RÉSISTANCE

- Rayon de courbure
- Tenue aux torsions
- Mémoire de forme
- Tenue aux chocs
- Tenue à l'abrasion
- Longévité
- Tenue à l'hydrolyse
- Qualité : Polyéther 95° A shores
- Faible rayon de courbure



RACCORD FIXE

Raccord fixe côté alimentation

Caractéristiques techniques des 2 raccords (fixe et rotatif)

- Raccords en laiton nickelé
- Filetages prétéflonnés
- Protectors PVC pour protection du tuyau



RACCORD ROTATIF

Raccord rotatif côté outil pneumatique

- Raccord monté sur roulement à billes : rotation aisée même sous pression
- Pas de contraintes néfastes sur les spires du tuyau...



TUYAU SPIRALÉ POLYAMIDE SPIC

SOUPLESSE ET RÉSISTANCE

- Tenue à la pression
- Tenue aux chocs
- Tenue aux températures
- Tenue à l'hydrolyse
- Tenue aux produits chimiques
- Compatible huiles / hydrocarbures



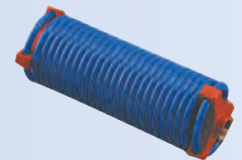

ÉQUILIBREUR AVEC TUYAU SPIRALÉ SPI

- ▶ Alimentation de l'outil par tuyau spiralé polyamide
- ▶ Suspension de l'outil par ressort axial torsadé en cône pour une extension et un retrait rapide
- ▶ Principe simple et donc très fiable même dans des conditions d'emploi sévères
- ▶ 3 fixations possibles de l'équilibreur au réseau :
 - Par embout et raccord rapide de sécurité
 - Par flexible souple pour réglage de la hauteur de l'outil
 - Par vissage direct au réseau d'air comprimé



SPIRALES POLYURETHANE AVEC RACCORDS

Confort d'utilisation	Souplesse Flexibilité	Matière Polyuréthane Polyether 98 A shore	Raccord fixe Préfléonné Anti rayures	Température Max. 70°C	Pression P.N.8 bar	Raccord rotatif Préfléonné Anti rayures	Exempt de silicone
-----------------------	--------------------------	---	--	--------------------------	-----------------------	---	--------------------

		Couleur	Diamètre int/ext en mm	Longueur Maxi m	Raccord fixe Côté alimentation	Diamètre des spires mm	Longueur Mini m	Raccord rotatif Côté outil	REFERENCE
Mini tuyau spiralé polyuréthane équipé de raccords instantanés									
	Spiralés équipés de raccords instantanés RPD MG								
	Bleu	2,5 x 4	2	G 1/8	24	0,19	G 1/8	PUS 22	
	Bleu	2,5 x 4	4	G 1/8	24	0,39	G 1/8	PUS 24	
	Bleu	4 x 6	2	G 1/4	32	0,23	G 1/4	PUS 42	
	Bleu	4 x 6	4	G 1/4	32	0,48	G 1/4	PUS 44	
Tuyau spiralé polyuréthane équipé de raccords mâles fixe et rotatif									
	Les spiralés PUS 114 et PUS 118 sont équipés de raccords fixes sans protecteur aux deux extrémités.								
	Bleu	5 x 8	2	R 1/4	42	0.18	R 1/4	PUS 52	
	Bleu	5 x 8	4	R 1/4	42	0.40	R 1/4	PUS 54	
	Bleu	5 x 8	6	R 1/4	42	0.60	R 1/4	PUS 56	
	Bleu	5 x 8	8	R 1/4	42	0.80	R 1/4	PUS 58	
	Bleu	6.5 x 10	4	R 1/4	52	0.40	R 1/4	PUS 64	
	Bleu	6.5 x 10	6	R 1/4	52	0.63	R 1/4	PUS 66	
	Bleu	6.5 x 10	8	R 1/4	52	0.80	R 1/4	PUS 68	
	Bleu	6.5 x 10	10	R 1/4	52	0.95	R 1/4	PUS 610	
	Bleu	8 X 12	4	R 3/8	65	0.40	R 3/8	PUS 84	
	Bleu	8 x 12	6	R 3/8	65	0.65	R 3/8	PUS 86	
	Bleu	8 x 12	8	R 3/8	65	0.72	R 3/8	PUS 88	
	Bleu	8 x 12	15	R 3/8	65	1.35	R 3/8	PUS 815	
	Bleu	11 x 16	4	R 1/2 Fixe	90	0.40	R 1/2 Fixe	PUS 114	
	Bleu	11 x 16	8	R 1/2 Fixe	90	0.80	R 1/2 Fixe	PUS 118	
Tuyau spiralé polyuréthane : équipé de raccords mâles fixe et rotatif									
	Rouge	6.5 x 10	4	R 1/4	42	0.40	R 1/4	PUS 64R	
	Rouge	6.5 x 10	6	R 1/4	52	0.63	R 1/4	PUS 66R	
Tuyau spiralé polyuréthane : équipé de raccords mâles fixe et rotatif									
	Jaune	6.5 x 10	4	R 1/4	42	0.40	R 1/4	PUS 64J	
	Jaune	6.5 x 10	6	R 1/4	52	0.63	R 1/4	PUS 66J	
Tuyau spiralé polyuréthane : équipé de raccords mâles fixe et rotatif									
	Vert	6.5 x 10	4	R 1/4	42	0.40	R 1/4	PUS 64V	
	Vert	6.5 x 10	6	R 1/4	52	0.63	R 1/4	PUS 66V	

SPIRALES POLYURETHANE AVEC RACCORDS

Confort d'utilisation	Souplesse Flexibilité	Matière Polyuréthane Polyether 98 A shore	Raccord fixe Prétéflonné Anti rayures	Température Max. 70°C	Pression P.N.8 bar	Raccord rotatif Prétéflonné Anti rayures	Exempt de silicone
-----------------------	--------------------------	---	---	--------------------------	-----------------------	--	--------------------

		Couleur	Diamètre int/ext en mm	Longueur Maxi m	Raccord fixe Côté alimentation	Diamètre des spires mm	Longueur Mini m	Raccord rotatif Côté outil	REFERENCE
Tuyau spiralé polyuréthane : équipé de raccords mâles fixe et rotatif									
		Noir	6.5 x 10	4	R 1/4	42	0.40	R 1/4	PUS 64NR
		Noir	6.5 x 10	6	R 1/4	52	0.63	R 1/4	PUS 66NR

TUYAUX SPIRALES POLYURETHANE/PVC

Matière Polyuréthane/PVC Polyether 95 A shore	Raccord fixe Laiton nickelé	Pression P.N.10 bar	Température - 40°C à +70°C	Confort d'utilisation	Compatible Huiles, Graisses, Ozone, Solutions aqueuses, UV	Auto extinguable
---	--------------------------------	------------------------	-------------------------------	-----------------------	--	------------------





		DESIGNATION						REFERENCE
Tuyau spiralé polyuréthane/PVC : équipé de raccords mâles fixes Spécial ambiance soudure								
		Spiralé pour usages sévères - Haute résistance. Applications : ateliers à usages intensifs, ateliers de soudure, meulage, ébarbage, disquage. Résistance aux particules incandescentes, à l'inflammabilité suivant la norme UL 94 4-0 (le matériau ne propage pas la flamme).						
		Ø en mm	Long. m	Filetage mâle				
		6,5 x 10	6	G 1/4			PUS 66CX	
	8 x 12	6	G 3/8			PUS 86CX		

TUYAUX SPIRALES EQUIPES D'UN RACCORD ET D'UN EMBOUT

Souplesse	Raccord rotatif	Température Max 70 °C	Pression	Matière
-----------	-----------------	--------------------------	----------	---------

		Couleur	Diamètre int/ext en mm	Longueur Maxi m	Diamètre des spires mm	Longueur Mini m	Equipé d'un raccord	REFERENCE
Tuyau spiralé polyuréthane équipé d'un raccord de sécurité et d'un embout								
		Bleu	6,5 x 10	4	42	0.40	ISI 06	PUS 64IS
		Bleu	6,5 x 10	6	52	0.63	ISI 06	PUS 66IS
		Bleu	8 x 12	6	65	0.65	ISI 06	PUS 86IS

TUYAUX SPIRALES POLYAMIDE

Compatible Air, eau		Compatibilité Produits chimiques		Pression P.N.10 bar		Température Max.90°C		Matière Polyamide		Raccord Plein débit	
		Couleur	Diamètre int./ext en mm	Longueur Max. m	Raccord rotatif 2 extrémités	Diamètre des spires mm	Longueur Mini m	REFERENCE			
Tuyau spiralé polyamide équipé de raccords mâles tournants											
	Bleu	6 x 8	2.5	G 1/4	96	0.12	SPIC 62				
	Bleu	6 x 8	5	G 1/4	96	0.24	SPIC 65				
	Bleu	6 x 8	10	G 1/4	96	0.48	SPIC 610				
	Bleu	6 x 8	20	G 1/4	96	0.96	SPIC 620				
	Bleu	8 x 10	2,5	G 1/4	110	0.14	SPIC 82				
	Bleu	8 x 10	5	G 1/4	110	0.28	SPIC 85				
	Bleu	8 x 10	10	G 1/4	110	0.55	SPIC 810				
	Bleu	8 x 10	20	G 1/4	110	1.10	SPIC 820				
	Bleu	9.5 x 12	2,5	G 3/8	144	0.12	SPIC 102				
	Bleu	9.5 x 12	17	G 3/8	144	0.97	SPIC 1016				
	Bleu	9.5 x 12	4	G 3/8	144	0.24	SPIC 104				
Bleu	9.5 x 12	8.5	G 3/8	144	0.49	SPIC 108					
Tuyau spiralé polyamide équipé de raccords mâles fixes											
	Bleu	6 x 8	5	Fixe G 1/4	96	0.25	SPIC 65FX				
	Bleu	6 x 8	10	Fixe G 1/4	96	0.50	SPIC 610FX				
	Bleu	6 x 8	20	Fixe G 1/4	96	1.00	SPIC 620FX				
	Bleu	8 x 10	5	Fixe G 1/4	110	0.25	SPIC 85FX				
	Bleu	8 x 10	10	Fixe G 1/4	110	0.50	SPIC 810FX				
	Bleu	8 x 10	20	Fixe G 1/4	110	1.00	SPIC 820FX				
Tuyau spiralé polyamide "spécial bouts redressés" - raccords mâles fixes											
	Bleu	6.5 x 8	5	Fixe G 1/4	78	0.6	SPI 95				
Tuyau spiralé polyamide nu sans raccord											
	Bleu	2.7 x 4	10		28	1.06	SPIR 2710				
	Bleu	4.5 x 6	12		52	1.00	SPIR 456				
	Bleu	4 x 6	26		72	1.33	SPIR 4526				
	Bleu	6 x 8	10		96	0.48	SPIR 610				
	Bleu	6 x 8	20		96	0.96	SPIR 620				
	Bleu	8 x 10	20		110	1.10	SPIR 820				
	Bleu	9.5 x 12	17		144	0.97	SPIR 1016				
	Bleu	12.7 x 16	24		222	1.33	SPIR 12730				
	Bleu	16 x 20	20		230	1.33	SPIR 1630				



TUYAUX SPIRALES EQUIPES DE SOUFFLETTES

Pression PN 8 bar		Soufflesse		Etanche Monté étanche		Ergonomie du poste de travail		Facilement transportable	
		Diamètre int./ ext mm	Equipé d'un raccord	Longueur m	Matière spirale	Equipé d'un embout	Equipé d'une soufflette	Equipé d'une jonction	REFERENCE
Ensemble avec 27102 MTL, spirale Polyamide, raccordement fixe G 1/4 BSP									
	Ensemble comprenant : 1 spirale polyamide G 1/4 BSP mâle 1 soufflette 27102 MTL								
	6.5 x 8	Fixe	5	Polyamide		27102 MTL			HELICOL 3
Ensemble avec soufflette à déformation, raccordement fixe G 1/4 BSP									
	Ensemble comprenant : 1 spirale polyuréthane G 1/4 BSP mâle 1 soufflette anti-rayure								
	4 x 6		4	Polyuré- thane		SDA à déformation progressive			HELICOL 4
Ensemble de soufflage avec STL 101, spirale et raccord rapide standard									
	Ensemble comprenant : 1 spirale polyuréthane 1 raccord IRC 06 et 2 embouts IRP 06 1 soufflette STL 101								
	5 x 8	IRC 061101	2	Polyuré- thane	IRP 066151+ 066101	STL 101			HELICOL 8
Ensemble de soufflage avec Force 3, spirale et raccord rapide métal									
	Ensemble comprenant : 1 spirale polyamide 1 raccord IRM 06 et 2 embouts IRP 06 1 soufflette FORCE 3								
	6.5 x 8	IRM 061101	4.5	Polyuré- thane	IRP 066101	FORCE 3			HELICOL 1
Ensemble de soufflage avec Force 3, spirale et raccord rapide métal									
	Ensemble comprenant : 1 spirale polyuréthane 1 raccord IRM 06 et 2 embouts IRP 06 1 soufflette FORCE 3								
	5 x 8	IRM 061101	2	Polyuré- thane	IRP 066101	FORCE 3			HELICOL 2



TUYAUX SPIRALES EQUIPES DE SOUFFLETES

Pression PN 8 bar	Souplesse	Etanche Monté étanche	Ergonomie du poste de travail		Facilement transportable				
		Diamètre int./ ext mm	Equipé d'un raccord	Longueur m	Matière spirale	Equipé d'un embout	Equipé d'une soufflette	Equipé d'une jonction	REFERENCE
Ensemble avec 27102 MTL, spiralé, raccordement fixe G 1/4 BSP									
	Ensemble comprenant : 1 spiralé polyuréthane G 1/4 BSP mâle 1 soufflette 27102 MTL								
	5 x 8	Fixe	2	Polyuréthane		27102 MTL		HELICOL 6	
	5 x 8	Fixe	4	Polyuréthane		27102 MTL		HELICOL 7	

RACCORDS POUR TUYAUX SPIRALES POLYURETHANE

Anti rayures Protection du tuyau	Prétéflonné	Raccord rotatif Roulement à billes	Matière Protecteur PVC	Raccord fixe	Matière Raccord laiton nickelé	Raccord Plein débit
		Diamètre int.ext mm	Filetage mâle	Raccord rotatif	Raccord fixe	REFERENCE
Raccord rotatif préteflonné "Spécial Polyuréthane"						
	5 x 8	R 1/4	Rotatif		PUR 813R	
	6.5 x 10	R 1/4	Rotatif		PUR 1013R	
	8 x 12	R 3/8	Rotatif		PUR 1238R	
Raccord fixe préteflonné "Spécial polyuréthane"						
	5 x 8	R 1/4		Fixe	PUR 813F	
	6.5 x 10	R 1/4		Fixe	PUR 1013F	
	8 x 12	R 3/8		Fixe	PUR 1238F	
	11 x 16	R 1/2		Fixe	PUR 1121F	

RACCORDS POUR TUYAUX SPIRALES POLYAMIDE

Matière Raccord laiton nickelé		Protection du tuyau Ressort de protection		Raccord Plein débit		
		Diamètre int./ext mm	Filetage Gaz BSP	Raccord rotatif	Raccord fixe	REFERENCE
Raccord tournant "Spécial Polyamide"						
		4 x 6	G 1/4 mâle	Tournant		20
		6 x 8	G 1/4 mâle	Tournant		22
		8 x 10	G 1/4 mâle	Tournant		25
		8 x 10	G 3/8 mâle	Tournant		25M38
		10 x 12	G 3/8 mâle	Tournant		27
		10 x 12	G 3/8 femelle	Tournant		27F38
Raccord fixe "Spécial Polyamide"						
		4 x 6	G 1/4 mâle		Fixe	20FX
		6 x 8	G 1/4 mâle		Fixe	22FX
		8 x 10	G 1/4 mâle		Fixe	25FX
		10 x 12	G 3/8 mâle		Fixe	27FX
		12.7 x 16	G 1/2 mâle		Fixe	29FX
		16 x 20	G 3/4 mâle		Fixe	30FX

EQUILIBREURS SPIRALEX AVEC TUYAU SPIRALÉ

Effort physique diminué	Economique	Solution simple	Longévité	Fluide Air	Application automobile	Applications industrielles
-------------------------	------------	-----------------	-----------	---------------	------------------------	-------------------------------

		Poids de l'outil kg	Sortie Gaz BSP	Tube spiralé mm	Longueur Maxi en m	Longueur Mini en m	REFERENCE
Equilibreurs avec tuyau spiralé							
		0.2 à 0.5	G 1/4 Mâle	4.5 x 6	0.65	0.28 à 0.45	SPI 1
		0.7 à 2	G 1/4 femelle	6.3 x 8	1.06	0.46 à 0.90	SPI 3
		2.5 à 5	G 3/8 Femelle	9.5 x 12	1.45	0.92 à 1.42	SPI 5
		6 à 10	G 3/8 Femelle	9.5 x 12	1.44	0.70 à 0.98	SPI 7

colliers de serrage

COLLIERS À OREILLES

FIXATIONS DÉFINITIVES

AVANTAGES TECHNIQUES

- Produits indesserrables
- Couple de serrage très important
- Résistance à la corrosion
- Facilité et rapidité de montage
- Présentation soignée
- Ébavurage parfait évitant tout risque de blessure
- Solution très économique
- Utilisation dans une plage de pressions très large

CHOISIR

COMMENT CHOISIR VOTRE COLLIER À OREILLES ?

- A - Déterminer le diamètre extérieur du tuyau à sertir.
- B - Ajouter 1 mm.
- C - Vous obtenez le diamètre à choisir dans la gamme des colliers.

MONTER

COMMENT MONTER VOTRE COLLIER À OREILLES ?

- 1 - Positionner le collier sur la pièce à sertir.



- 2 - Introduire le tuyau entre le collier et la pièce.

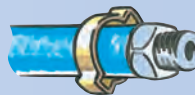

- 3 - Serrer progressivement, en 4 opérations successives, à l'aide de la pince SER 02.



DÉMONTER







COMMENT DÉMONTER VOTRE COLLIER À OREILLES

Couper le collier dans le sens de la largeur de la bande à l'aide de la tenaille.

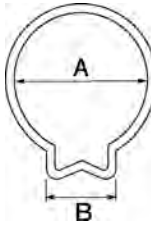

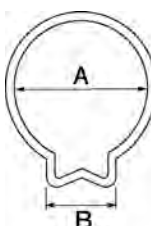

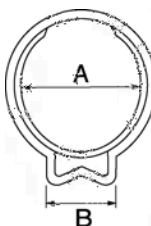
COLLIERS À 1 OREILLE

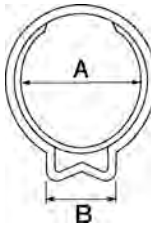
Collier indesserrable	Diamètre Gamme étendue	Ebavuré	Economique	Serrage très important	Matière Acier zingué traité	Sécurité d'utilisation	Montage Facilité de montage
-----------------------	---------------------------	---------	------------	---------------------------	--------------------------------	---------------------------	-----------------------------------

		A	B	Diamètre Mini / Maxi en mm	Largeur de bande mm	Nombre d'oreilles	Conditionnement	REFERENCE
Type standard acier traité								
		9.3	5.5	7 - 9	6	1	100	0709E
		10.3	6	8 - 10	6	1	100	0810E
		11.3	6.5	9 - 11	6.5	1	100	0911E
		12.3	7	10 - 12	6.5	1	100	1012E
		13.3	7.5	11 - 13	6.5	1	100	1113E
		14.3	8	12 - 14	7	1	100	1214E
		16.3	8.5	14 - 16	7	1	100	1416E
		18.5	9.5	16 - 18	7	1	100	1618E
Type Inox								
		9.3	5.5	7 - 9	6	1	100	INOX 0709E
		10.3	6	8 - 10	6	1	100	INOX 0810E
		11.3	6.5	9 - 11	6.5	1	100	INOX 0911E
		12.3	7	10 - 12	6.5	1	100	INOX 1012E
		13.3	7.5	11 - 13	6.5	1	100	INOX 1113E
		14.3	8	12 - 14	7	1	100	INOX 1214E
		15.3	8	13 - 15	7	1	100	INOX 1315E
		16.3	8.5	14 - 16	7	1	100	INOX 1416E
		17.5	9	15 - 17	7	1	100	INOX 1517E
		18.5	9	16 - 18	7	1	100	INOX 1618E
		19.5	9.5	17 - 19	7.5	1	100	INOX 1719E
20.5	10	18 - 20	7.5	1	100	INOX 1820E		
Type standard à bague - acier traité								
		8.5	5.5	7.5 - 8.5	6	1	100	0708EG
		9.5	6	8 - 9.5	6	1	100	0809EG
		10.5	6.5	9 - 10.5	6.5	1	100	0910EG
		11.5	7	10 - 11.5	6.5	1	100	1011EG
		12.5	7.5	10.5 - 12.5	6.5	1	100	1012EG
		13.3	8	11.5 - 13.3	7	1	100	1113EG
		15.3	8.5	13 - 15.3	7	1	100	1315EG
17.3	9.5	15 - 17.3	7	1	100	1517EG		
Type Inox à bague								
		8.5	5.5	7.5 - 8.5	6	1	100	INOX 0708EG
		9.5	6	8.2 - 9.5	6	1	100	INOX 0809EG
		10.5	6.5	9 - 10.5	6.5	1	100	INOX 0910EG
		11.5	7	10 - 11.5	6.5	1	100	INOX 1011EG
		12.5	7.5	10.5 - 12.5	6.5	1	100	INOX 1012EG
		13.5	8	11.5 - 13.5	7	1	100	INOX 1113EG
		14.5	8	12.5 - 14.5	7	1	100	INOX 1314EG
		15.3	8.5	13 - 15.3	7	1	100	INOX 1315EG
		16.3	9	14 - 16.3	7	1	100	INOX 1416EG
		17.3	9.5	15 - 17.3	7	1	100	INOX 1517EG
		18.3	9.5	16 - 18.3	7.5	1	100	INOX 1618EG
19.3	10	17 - 19.3	7.5	1	100	INOX 1719EG		

COLLIERS À 2 OREILLES

Facilité d'emploi	Montage Facilité de montage	Collier indesserrable	Diamètre Gamme étendue	Ebavuré	Economique	Serrage très important	Matière Acier traité	Sécurité d'utilisation
-------------------	---------------------------------------	--------------------------	----------------------------------	---------	------------	----------------------------------	--------------------------------	----------------------------------

		A	B	Largeur de bande mm	Conditionnement	Nombre d'oreilles	Diamètre Min/Max mm	REFERENCE
Colliers à 2 oreilles type standard, acier traité								
		7.3	3	6	100	2	05 - 07	0507
		9.3	3	6	100	2	07 - 09	0709
		11.3	3	7	100	2	09 - 11	0911
		13.3	3.5	7	100	2	11 - 13	1113
		15.3	3.5	7	100	2	13 - 15	1315
		17.5	4.5	7	100	2	14 - 17	1517
		18.5	4.5	7	100	2	15 - 18	1518
		20.5	5.5	7	100	2	17 - 20	1720
		21.5	5.5	7	100	2	18 - 21	1821
		23.5	5.5	8	100	2	20 - 23	2023
		25.5	6	9	100	2	22 - 25	2225
		27.5	6.5	9	100	2	23 - 27	2327
		28.5	7	9	100	2	25 - 28	2528
		31.5	7	9	100	2	28 - 31	2731
		34.5	7.5	9	100	2	31 - 34	3134
		37.5	7.5	9	100	2	34 - 37	3437
40.5	8	10	50	2	37 - 40	3740		
43.5	8.5	10	50	2	40 - 43	4043		
16.5	8.5	10	50	2	43 - 46	4346		
Colliers type double pour jumelage de tuyau, acier traité								
				9	100		12 - 13	1213D
				9	100		14-15	1415D
				9	100		16-17	1617D
				9	100		18-19	1819D
Colliers 2 oreilles type Inox, acier inox 304L								
		7.3	4.3	6	100	2	05 - 07	INOX 0507
		9.3	4.3	7	100	2	07 - 09	INOX 0709
		11.3	5.3	7	100	2	09 - 11	INOX 0911
		13.3	5.8	7	100	2	11 - 13	INOX 1113
		15.3	6.3	7	100	2	13 - 15	INOX 1315
		18.5	7	8	100	2	15 - 18	INOX 1518
		20.5	7.6	8	100	2	17 - 20	INOX 1720
		23.5	8.5	8	100	2	20 - 23	INOX 2023
Tenailles pour montage de colliers								
								SER 02
								SER 04
Boîte assortiment colliers à oreilles								
								BC 0927

colliers de serrage

COLLIERS À VIS

FIXATIONS RAPIDES ET SIMPLES

PBJ

COLLIERS À VIS À BANDE AJOURÉE

- ▶ **Souplesse de la bande perforée**
 - Économie
 - Possibilité de réalisation de colliers sur mesure et de grands diamètres (kit)

- ▶ **Toutes applications**

- ▶ **Kit de serrage**

Bande disponible en longueur de 3m, 5m et 25m permettant de réaliser un diamètre de collier sur mesure.

1 Matière

Acier électrozingué.

2 Bords relevés

Les bords relevés favorisent le positionnement du collier, éliminant tout risque de coupure du tuyau.

3 Carter embouti

Carter embouti électro-zingué.

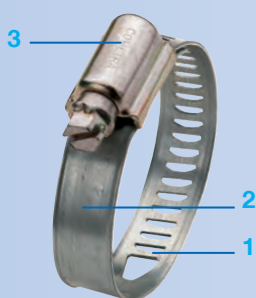

PBS - PBI - PBX

COLLIERS À VIS À BANDE PLEINE

- ▶ **Couple de serrage important**

- Fiabilité
- Pas de risque de desserrage
- Insensibilité aux vibrations
- Pression d'appui constante
- Résistance à la corrosion (PBI)
- Excellente tenue à la corrosion (PBX)
- Milieu alimentaire ou marin (PBX)

- ▶ **Toutes applications**

1 Matière

PBS - Construction acier carbone haute qualité, galvanisation et zingage de 10 à 14 microns.

PBI - Construction acier inox 304

PBX - Construction acier inox 316

2 Bords relevés

Les bords relevés favorisent le positionnement du collier, éliminant tout risque de coupure du tuyau.

3 Carter embouti

Les carters sont réalisés à partir de tubes acier, protégés par une laque anti-corrosion bleue.

4 Filets carrés

Engrènement par filets carrés. Les filets de la vis et les empreintes sont matricés, garantissant une fiabilité aux vibrations.



PBR

COLLIERS ROBUST

- **Applications sévères**
 - Couple de serrage élevé
 - Double maintien de la vis assurant fiabilité et longévité du mécanisme
 - Réduction des frottements et facilité d'accès
- **Toutes applications très sévères**
 - Eau - Air
 - Irrigation, pompage...

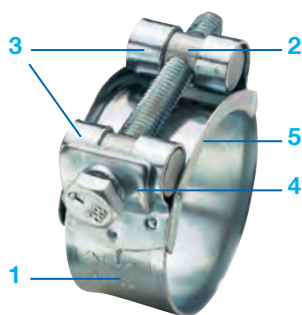

1 Matière

Acier carbone de haute qualité, galvanisation et zingage de 10 à 14 microns.

2 Système vis et écrou

Assurant un couple de serrage élevé.

3 Double maintien de la vis

4 Vis placée sur une rondelle
Réduit les frottements tout en le rendant plus accessible.

5 Chevalet de la bande

Placé sous la vis assurant :

- Protection du tuyau
- Couple de serrage élevé

PBC

COLLIERS GAINÉS CAOUTCHOUC

- **Fixation - Protection**
 - Suspension
 - Maintien
 - Absorption des vibrations
 - Protection des tuyaux
 - Étanchéité entre tubes et colliers
- **Applications**
 - Industrie automobile
 - Constructions navales
 - Réfrigération
 - Cablage



1 Matière

Bande d'acier galvanisé cintré.

2 Protection

Caoutchouc EPDM.

3 Serrage

Vis et écrou (non fournis).

4 Fixation

Trou de fixation oval pour faciliter l'ajustement.

PF

COLLIERS DOUBLE FIL GALVANISÉ

- **Technique bifilaire à écartement constant**
 - Solution économique pour les étanchéités difficiles, en particulier sur embouts lisses
- **Applications**
 - Pour tuyaux rigides et semi-rigides dont la section peut ne pas être parfaitement cylindrique
 - Climatisation
 - Conduites d'air

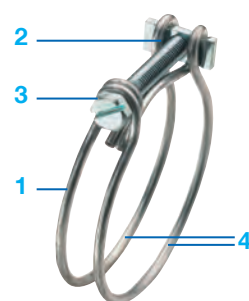

1 Matière

Acier zingué.

2 Serrage

Vis et écrou.

3 Tête

6 pans de 8 fendue.

4 Double fils

PBM

COLLIERS TYPE MINI

- Serrage pour tuyaux à paroi mince et de petites dimensions
- Pas de blessures du tuyau
- Parfaite étanchéité
- Bonne résistance

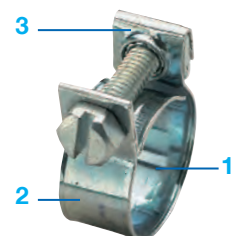

1 Matière

Acier zingué.

2 Bords relevés

Favorisant le positionnement du collier, éliminant tout risque de coupure du tuyau.

3 Écrou prisonnier

L'écrou demeure en place, même si la vis est ôtée.

PBP

COLLIERS TYPE MICRO

- Serrage pour tuyaux de petits diamètres
- Adaptés aux endroits exigus

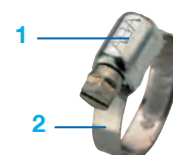

1 Matière



Acier électrozingué chromé blanc.

2 Bande de 5mm

Micro-carter adapté.

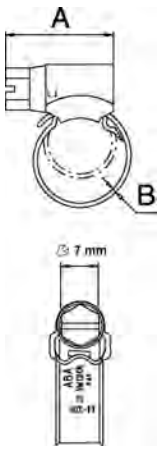

COLLIERS À VIS À BANDE PLEINE

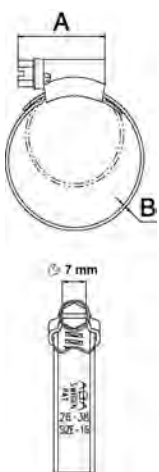
Filet carré Bandes matricées	Carter embouti d'une pièce	Bords de colliers relevés	Serrage très important	Diamètre Gamme étendue	Matière Acier/carbone haute qualité	Anti chocs Résistance aux chocs
---------------------------------	-------------------------------	------------------------------	---------------------------	---------------------------	---	------------------------------------

		A	B	Diamètre Mini/Max. en mm	Largeur de bande mm	Serrage couple en Nm	Conditionnement Boîte carton	REFERENCE		
Colliers à vis type standard - Bande de 9 mm										
		20	0.8	08 - 14	9	2.5 - 3.5	100	PBS9 814		
		20	0.8	11 - 17	9	2.5 - 3.5	100	PBS9 1117		
		20	0.8	13 - 20	9	3 - 4	100	PBS9 1320		
		24	0.8	15 - 24	9	3 - 4	50	PBS9 1524		
		24	0.8	19 - 28	9	3 - 4	50	PBS9 1928		
		24	0.8	22 - 32	9	3 - 4	50	PBS9 2232		
		24	0.8	26 - 38	9	4 - 4.5	25	PBS9 2638		
		29	0.8	32 - 44	9	4 - 4.5	25	PBS9 3244		
		29	0.8	38 - 50	9	4 - 4.5	25	PBS9 3850		
		29	0.8	44 - 56	9	4 - 4.5	25	PBS9 4456		
		32	0.8	50 - 65	9	4 - 4.5	25	PBS9 5065		
		Colliers à vis type standard - Bande de 12 mm								
				22	0.8	15 - 24	12	4 - 4.5	50	PBS12 1524
				23	0.8	19 - 28	12	4 - 4.5	50	PBS12 1928
25	0.8			22 - 32	12	4 - 4.5	50	PBS12 2232		
25	0.8			26 - 38	12	4 - 4.5	25	PBS12 2638		
29	1			32 - 44	12	5 - 6	25	PBS12 3244		
29	1			38 - 50	12	5 - 6	25	PBS12 3850		
29	1			44 - 56	12	5 - 6	25	PBS12 4456		
32	1			50 - 65	12	5 - 6	25	PBS12 5065		
32	1			58 - 75	12	5 - 6	25	PBS12 5875		
32	1			68 - 85	12	5 - 6	10	PBS12 6885		
32	1			77 - 95	12	5 - 6	10	PBS12 7795		
32	1			87 - 112	12	5 - 6	10	PBS12 87112		
32	1			106 - 138	12	5 - 6	10	PBS12 104138		
32	1			132 - 165	12	5 - 6	10	PBS12 130165		
32	1			150 - 180	12	5 - 6	10	PBS12 150180		
32	1			175 - 205	12	5 - 6	10	PBS12 175205		
32	1			200 - 231	12	5 - 6	10	PBS12 200231		
32	1			226 - 256	12	5 - 6	10	PBS12 226256		
32	1			251 - 282	12	5 - 6	10	PBS12 251282		
32	1			277 - 307	12	5 - 6	10	PBS12 277307		

COLLIERS À VIS INOX À BANDE PLEINE

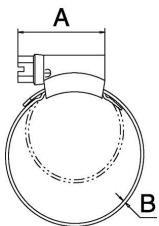
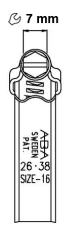
Filet carré Bandes matricées	Carter embouti d'une pièce	Bords de colliers relevés	Serrage très important	Matière Acier Inox	Gamme étendue	Fluide Ambiance corrosive
---------------------------------	-------------------------------	------------------------------	---------------------------	-----------------------	---------------	------------------------------

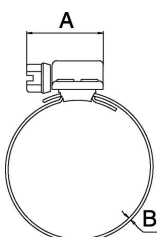
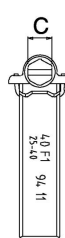
		A	B	Diamètre Min/Max.mm	Largeur de bande mm	Serrage couple en Nm	Conditionnement	REFERENCE
Colliers à vis série inox 304 - Bande de 12 mm								
	 	20	0.8	08 - 14	9	2.5 - 3.5	100	PBI9 814
		20	0.8	11 - 17	9	2.5 - 3.5	100	PBI9 1117
		20	0.8	13 - 20	9	3 - 4	100	PBI9 1320
		22	0.8	15 - 24	12	4 - 4.5	50	PBI12 1524
		23	0.8	19 - 28	12	4 - 4.5	50	PBI12 1928
		25	0.8	22 - 32	12	4 - 4.5	50	PBI12 2232
		25	0.8	26 - 38	12	4 - 4.5	25	PBI12 2638
		29	0.8	32 - 44	12	5 - 6	25	PBI12 3244
		29	0.8	38 - 50	12	5 - 6	25	PBI12 3850
		29	0.8	44 - 56	12	5 - 6	25	PBI12 4456
		32	0.8	50 - 65	12	5 - 6	25	PBI12 5065
		32	0.8	58 - 75	12	5 - 6	25	PBI12 5875
		32	0.8	68 - 85	12	5 - 6	10	PBI12 6885
		32	0.8	77 - 95	12	5 - 6	10	PBI12 7795
		32	0.8	87 - 112	12	5 - 6	10	PBI12 87112
		32	0.8	106 - 138	12	5 - 6	10	PBI12 104138
		32	0.8	132 - 165	12	5 - 6	10	PBI12 130165
		32	0.8	150 - 180	12	5 - 6	10	PBI12 150180
		32	0.8	175 - 205	12	5 - 6	10	PBI12 175205
		32	0.8	200 - 231	12	5 - 6	10	PBI12 200231
32	0.8	226 - 256	12	5 - 6	10	PBI12 226256		
32	0.8	251 - 282	12	5 - 6	10	PBI12 251282		
32	0.8	277 - 307	12	5 - 6	10	PBI12 277307		
Colliers à vis série inox 316 - Qualité marine - Bande de 12 mm								
	 	20	0.8	08 - 14	9	2,5 - 3,5	100	PBX9 814
		20	0.8	11 - 17	9	2.5 - 3.5	100	PBX9 1117
		20	0.8	13 - 20	9	3 - 4	100	PBX9 1320
		23	0.8	15 - 24	12	2,5 - 3,5	50	PBX12 1524
		23	0.8	19 - 28	12	2,5 - 3,5	50	PBX12 1928
		23	0.8	22 - 32	12	2,5 - 3,5	50	PBX12 2232
		23	0.8	26 - 38	12	3,5 - 4,5	25	PBX12 2638
		23	0.8	32 - 44	12	3,5 - 4,5	25	PBX12 3244
		23	0.8	38 - 50	12	3,5 - 4,5	25	PBX12 3850
		31	0.8	44 - 56	12	5 - 6	25	PBX12 4456
		31	0.8	50 - 65	12	5 - 6	25	PBX12 5065
		31	0.8	58 - 75	12	5 - 6	25	PBX12 5875
		31	0.8	68 - 85	12	5 - 6	10	PBX12 6885
		31	0.8	77 - 95	12	5 - 6	10	PBX12 7795
		31	0.8	87 - 112	12	5 - 6	10	PBX12 87112
		31	0.8	106 - 138	12	5 - 6	10	PBX12 104138
		31	0.8	132 - 165	12	5 - 6	10	PBX12 130165
		32	0.8	150 - 180	12	5 - 6	10	PBX12 150180
		32	0.8	175 - 205	12	5 - 6	10	PBX12 175205
		32	0.8	200 - 231	12	5 - 6	10	PBX12 200231
32	0.8	226 - 256	12	5 - 6	10	PBX12 226256		
32	0.8	251 - 282	12	5 - 6	10	PBX12 251282		
32	0.8	277 - 307	12	5 - 6	10	PBX12 277307		

COLLIERS À VIS À BANDE AJOURÉE

Souplesse de la bande ajourée		Bords de colliers relevés				Matière Acier électrozingué			Gamme étendue	
		A	B	C	D	Diamètre Min/max en mm	Largeur de bande mm	Serrage Nm	Conditionnement Boîte carton	REFERENCE
Colliers à vis type ajouré - Bande de 8 mm										
		18	0.7	8.7	12	10 - 18	8	3	100	PBJ9 1016
		18	0.7	8.7	12	14 - 24	8	3	100	PBJ9 1222
		18	0.7	8.7	12	18 - 28	8	3	50	PBJ9 1627
		18	0.7	8.7	12	24 - 36	8	3	50	PBJ9 2335
		18	0.7	8.7	12	25 - 45	8	3	25	PBJ9 3045
		18	0.7	8.7	12	32 - 52	8	3	25	PBJ9 3250
		18	0.7	8.7	12	47 - 67	8	4	25	PBJ9 5070
		18	0.7	8.7	12	77 - 97	8	4	10	PBJ9 7090
Colliers à vis type ajouré - Bande de 12 mm										
		28.7	0.8	11.1	15	16 - 27	12	5	50	PBJ12 1627
		28.7	0.8	11.1	15	23 - 35	12	5	50	PBJ12 2335
		28.7	0.8	11.1	15	30 - 45	12	5	25	PBJ12 3045
		28.7	0.8	11.1	15	50 - 70	12	7	25	PBJ12 5070
		28.7	0.8	11.1	15	70 - 90	12	7	10	PBJ12 7090
		28.7	0.8	11.1	15	90 - 110	12	7	10	PBJ12 90110
		28.7	0.8	11.1	15	110 - 130	12	7	10	PBJ12 110130

COLLIERS MINI ET MICRO

Largeur de bande Mini: 9 mm Micro: 5 mm		Bords de colliers relevés		Serrage Tuyaux petits diamètres		Serrage vis écrou		Serrage Tuyaux à paroi mince		Matière Acier électrozingué	
		A	Diamètre Mini/Max en mm	Serrage Nm	Conditionnement Boîte carton	Largeur de bande mm	REFERENCE				
Série type Mini (acier électrozingué) - Largeur de bande : 9 mm											
		0.5	6 x 8	1.5	100	9	PBM 8				
		0.5	7 x 9	1.5	100	9	PBM 9				
		0.5	8 x 10	1.5	100	9	PBM 10				
		0.5	9 x 11	1.5	100	9	PBM 11				
		0.5	9 x 12	1.5	100	9	PBM 12				
		0.5	10 x 13	1.5	100	9	PBM 13				
		0.5	11 x 14	1.5	100	9	PBM 14				
		0.5	12 x 15	1.5	100	9	PBM 15				
		0.5	13 x 16	1.5	100	9	PBM 16				
		0.5	14 x 17	1.5	100	9	PBM 17				
Colliers série type Micro (acier électrozingué) - Largeur de bande : 5 mm											
			7 x 11	0.5 - 0.7	50	5	PBP 711				
			11 x 19	0.5 - 0.7	100	5	PBP 1119				

COLLIERS ROBUST

Applications sévères Colliers pour serrage difficile	Bords de colliers relevés	Serrage Couple de serrage très important	Serrage vis écrou	Matière Vis acier carbone haute qualité	Gamme étendue	Matière Carter et bande acier inox 430
---	---------------------------	--	-------------------	---	---------------	--

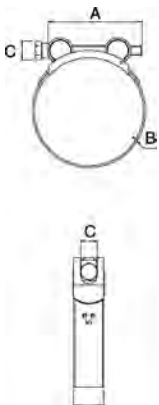
		A	B	Diamètre Min/Max mm	Largeur de bande mm	Serrage Nm	Serrage vis écrou	Conditionnement	Vis (C)	REFERENCE
Colliers Robust - Bande large										
		40	0.6	17 - 19	18 mm	8	M6 x 40	10	8	PBR 1719
		40	0.6	19 - 21	18 mm	8	M6 x 40	10	8	PBR 1921
		40	0.6	21 - 23	18 mm	8	M6 x 40	10	8	PBR 2123
		40	0.6	23 - 25	18 mm	12	M6 x 40	10	8	PBR 2325
		40	0.6	25 - 27	18 mm	12	M6 x 40	10	8	PBR 2527
		40	0.6	27 - 29	18 mm	12	M6 x 40	10	8	PBR 2729
		40	0.6	29 - 31	18 mm	12	M6 x 40	10	8	PBR 2931
		40	0.6	31 - 34	18 mm	12	M6 x 40	10	8	PBR 3134
		40	0.6	34 - 37	18 mm	12	M6 x 40	10	8	PBR 3437
		40	0.6	37 - 40	18 mm	12	M6 x 40	10	8	PBR 3740
		40	0.6	40 - 43	18 mm	12	M6 x 40	10	8	PBR 4043
		45	0.8	43 - 47	20 mm	23	M7 x 55	10	CHC 5	PBR 4347
		45	0.8	47 - 51	20 mm	23	M7 x 55	10	CHC 5	PBR 4751
		45	0.8	51 - 55	20 mm	23	M7 x 55	10	CHC 5	PBR 5155
		45	0.8	55 - 59	20 mm	23	M7 x 55	10	CHC 5	PBR 5559
		45	0.8	59 - 63	20 mm	23	M7 x 55	10	CHC 5	PBR 5963
		45	0.8	63 - 68	20 mm	23	M7 x 55	10	CHC 5	PBR 6368
		45	0.8	68 - 73	20 mm	23	M7 x 45	10	CHC 5	PBR 6873
		45	0.8	79 - 79	20 mm	23	M7 x 55	10	CHC 5	PBR 7379
		45	0.8	79 - 85	20 mm	23	M7 x 55	10	CHC 5	PBR 7985
		45	0.8	85 - 91	20 mm	23	M7 x 55	10	CHC 5	PBR 8591
		55	0.8	91 - 97	20 mm	23	M7 x 55	10	CHC 5	PBR 9197
		55	0.8	97-104	20 mm	23	M7 x 55	10	CHC 5	PBR 97104
		55	0.8	104-111	20 mm	23	M7 x 55	10	CHC 5	PBR 104111
		55	0.8	111-118	20 mm	23	M7 x 55	10	CHC 5	PBR 111118
		55	0.8	118-125	20 mm	23	M7 x 55	10	CHC 5	PBR 118125
		55	0.8	125-132	20 mm	23	M7 x 55	10	CHC 5	PBR 125132
		55	0.8	132-139	20 mm	23	M7 x 55	10	CHC 5	PBR 132139
		55	0.8	139-146	20 mm	23	M7 x 55	10	CHC 5	PBR 139146
		55	0.8	146-153	20 mm	23	M7 x 55	10	CHC 5	PBR 146153
		55	0.8	153-160	20 mm	23	M7 x 55	10	CHC 5	PBR 153160
		55	0.8	160-167	20 mm	23	M7 x 55	10	CHC 5	PBR 160167
55	0.8	167-174	20 mm	36	M7 x 55	10	CHC 5	PBR 167174		
80	1	174-187	30 mm	36	M10x80	10	17	PBR 174187		
80	1	187-200	30 mm	36	M10x80	10	17	PBR 187200		
80	1	200-213	30 mm	36	M10x80	10	17	PBR 200213		
80	1	213-226	30 mm	36	M10x80	10	17	PBR 213226		
80	1	226-239	30 mm	36	M10x80	10	17	PBR 226239		
80	1	239-252	30 mm	36	M10x80	10	17	PBR 239252		

COLLIERS GAINES CAOUTCHOUC

Gainé caoutchouc	Elimination des vibrations	Serrage vis écrou	Matière Acier carbone haute qualité	Gamme étendue	Matière Bande acier galvanisée
------------------	----------------------------	-------------------	---	---------------	--

		A	B	Diamètre	Largeur de bande mm	Serrage vis écrou	Conditionnement	REFERENCE
Colliers gainés caoutchouc - Bande de 12 mm								
		1.5	10.5	6	12	M5	50	PBC 126
		1.5	12	8	12	M5	50	PBC 128
		1.5	13	10	12	M5	50	PBC 1210
		1.5	14	12	12	M5	50	PBC 1212
		1.5	15.5	15	12	M5	50	PBC 1215
		1.5	18	20	12	M5	50	PBC 1220
		1.5	19	22	12	M5	50	PBC 1222
		1.5	20.5	25	12	M5	50	PBC 1225
Colliers gainés caoutchouc - Bande de 15 mm								
		1.8	13.7	6	15	M6	50	PBC 156
		1.8	15.2	8	15	M6	50	PBC 158
		1.8	16.2	10	15	M6	50	PBC 1510
		1.8	17.2	12	15	M6	50	PBC 1512
		1.8	18.7	15	15	M6	50	PBC 1515
		1.8	21.2	20	15	M6	50	PBC 1520
		1.8	22.2	22	15	M6	50	PBC 1522
		1.8	23.7	25	15	M6	50	PBC 1525
		1.8	25.2	28	15	M6	50	PBC 1528
		1.8	26.2	30	15	M6	50	PBC 1530
		1.8	27.2	32	15	M6	50	PBC 1532
		1.8	28.7	35	15	M6	50	PBC 1535
		1.8	30.2	38	15	M6	50	PBC 1538
1.8	31.2	40	15	M6	50	PBC 1540		

COLLIERS DOUBLE FILS GALVANISES

Economique	Solution simple	Matière Acier zingué
------------	-----------------	--------------------------------

		A	B	Diamètre Min/Max mm	Nombre de vis	Conditionnement	Dimensions de la tête de vis mm	REFERENCE
Colliers double fils galvanisés - Bande de 8 mm								
		28.5	13	13 - 16	1	50	8	PF 1316
		28.5	13	15 - 21	1	50	8	PF 1521
		28.5	13	20 - 23	1	50	8	PF 2023
		33.5	13	22 - 25	1	50	8	PF 2225
		33.5	13	24 - 27	1	50	8	PF 2427
		33.5	13	27 - 31	1	50	8	PF 2731
		33.5	13	31 - 35	1	50	8	PF 3135
		43.5	13	35 - 40	1	50	8	PF 3540
		43.5	13	38 - 43	1	50	8	PF 3843
		43.5	13	43 - 48	1	50	8	PF 4348
		43.5	13	45 - 50	1	50	8	PF 4550
		43.5	13	49 - 55	1	50	8	PF 4955
		43.5	13	54 - 60	1	50	8	PF 5460
		43.5	13	59 - 65	1	50	8	PF 5965
		43.5	13	64 - 70	1	25	88	PF 6470
		43.5	13	69 - 75	1	25	8	PF 6975
		43.5	13	73 - 80	1	25	8	PF 7380
		43.5	13	78 - 85	1	25	8	PF 7885

ACCESSOIRES COLLIERS À VIS

Etanchéité du serrage	Serrage pour tous types de tuyaux	Visuel attractif																					
DESIGNATION		REFERENCE																					
Présentoirs métalliques de colliers à vis																							
	Présentoir comprenant: 244 colliers à vis : - 100 type mini PBM et 144 type standard PBS - 1 tournevis flexible	DEPANNE 244																					
	Présentoir comprenant: 390 colliers à vis : - 90 type mini PBM et 300 type standard PBS - 1 tournevis flexible	DEPANNE 400																					
Boîtes d'assortiment																							
	Malette métallique comprenant: 133 colliers à vis : - 80 type mini PBM et 53 type standard PBS - 1 tournevis flexible	PRATIC 135																					
	Malette métallique comprenant: 270 colliers à vis standard PBS 1 tournevis flexible	PRATIC 300																					
	Coffret polypropylène à casiers modulables comprenant: 195 colliers à vis à bande ajourée	PBJ 195																					
	Valisette 7 casiers contenant : 150 colliers à vis à bande pleine pour tuyaux Ø ext. de 8 à 32 mm	PBS 150																					
Kit de serrage																							
	Ensemble comprenant : bande ajourée, carter articulé																						
	<table border="1"> <thead> <tr> <th>Long. bande</th> <th>Nbre carters</th> <th>Largeur bande</th> </tr> </thead> <tbody> <tr> <td>3 m</td> <td>8</td> <td>9</td> </tr> <tr> <td>5 m</td> <td>8</td> <td>9</td> </tr> <tr> <td>25 m</td> <td>0</td> <td>9</td> </tr> <tr> <td>3 m</td> <td>6</td> <td>12</td> </tr> <tr> <td>5 m</td> <td>6</td> <td>12</td> </tr> <tr> <td>25 m</td> <td>0</td> <td>12</td> </tr> </tbody> </table>	Long. bande	Nbre carters	Largeur bande	3 m	8	9	5 m	8	9	25 m	0	9	3 m	6	12	5 m	6	12	25 m	0	12	PBK 93
	Long. bande	Nbre carters	Largeur bande																				
	3 m	8	9																				
	5 m	8	9																				
	25 m	0	9																				
	3 m	6	12																				
5 m	6	12																					
25 m	0	12																					
	PBK 95																						
	PBK 925																						
	PBK 123																						
	PBK 125																						
	PBK 1225																						
Carters articulés																							
	100 carters articulés pour bande de 9 mm	PBK 09																					
	100 carters articulés pour bande de 12 mm	PBK 12																					
Tournevis flexible																							
	Pour tous les colliers à vis tête hexagonale de 7 mm	PB 3000																					

soufflettes

SOUFFLETTES PROGRESSIVES ET ERGONOMIQUES

UNE GAMME ADAPTÉE A VOS BESOINS

- ▶ Corps en matériau composite antirayure
- ▶ 5 types de soufflage



POSSIBILITÉ
DE CORPS EN COULEUR
AVEC PERSONNALISATION *



* nous consulter



TECHNOLOGIE MATIÈRE

Robuste, anti-rayures, isolant et antidérapant.
Matériau composite haute technologie.

RACCORDEMENT

Raccordement d'entrée équipé d'un insert en laiton : sécurité et étanchéité parfaite au montage.



MANIABILITÉ

Ergonomique, la soufflette est parfaitement adaptée à la morphologie de la main.



ACCROCHE

2 systèmes de suspension, sûrs et pratiques.

MÉCANISME PROTÉGÉ

Conception étanche à toutes intrusions d'éléments extérieurs risquant de bloquer le mécanisme.

DESIGN

Forme sans aspérités évitant les dépôts de poussières et de limailles sur le corps de la soufflette et la gachette

UTILISATION

Souplesse de la gachette pour un ajustement précis du débit et une progressivité d'ouverture du circuit d'air comprimé

SOUFFLAGE

Soufflage directionnel. L'angle de soufflage et l'orientation naturelle du jet d'air assurent un travail précis.

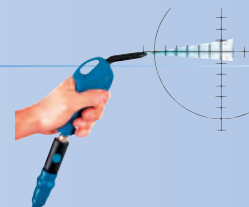

27102 MTL

Soufflette à buse métallique, longue et effilée

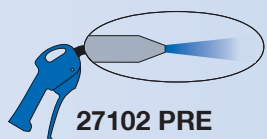

27102 PRE

Soufflette standard, soufflage direct et concentré

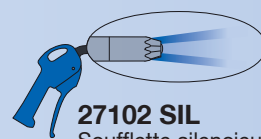

27102 SIL

Soufflette silencieuse : 77 dB, limitation du bruit dans l'atelier

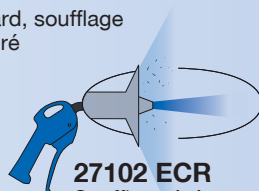

27102 ECR

Soufflette à écran d'air, protège des retours de poussières et copeaux

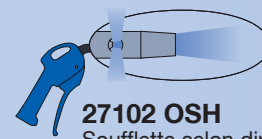

27102 OSH

Soufflette selon directive OSHA 1910.242B : pression de sortie limitée à 28 PSI (1,93 bar)

Débit pneumatique sous 6 bar pour 27102 PRE

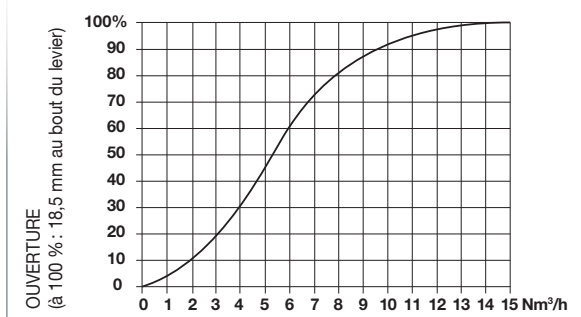









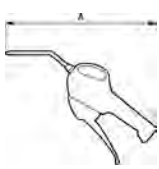

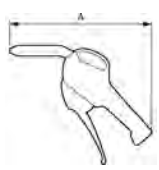
CARACTÉRISTIQUES TECHNIQUES

- > Pression maxi d'utilisation..... 10 bar
- > Température -15 à +70°C
- > Filetage G 1/4 femelle
- > Poids 110 g
- > Fluide air

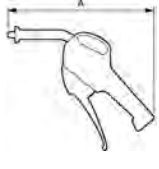

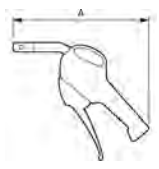
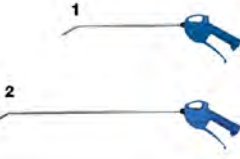
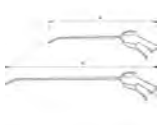

SOUFFLETTES 27102

Fluide Air	Insert laiton G 1/4 - F	Poids 110 g	Progressivité de soufflage	Pression P.N.10 bar	Température -15°C +70°C	Matière Composite antistatique	Anti rayures	Haute résistance mécanique
---------------	----------------------------	----------------	-------------------------------	------------------------	----------------------------	--------------------------------------	--------------	-------------------------------

		A	DESIGNATION	REFERENCE
Soufflette buse métallique				
		200	Débit : 23 Nm³/h à 6 bar Niveau sonore : 83 dB Buse métallique acier : Ø 3 x 6 mm Longueur coudée : 110 mm	27102 MTL
		-	Option soufflette avec limiteur de débit A 6 bar d'entrée, le jet d'air est équivalent à celui d'une soufflette standard avec une entrée à 3 bar.	27102 MTLBP3
Soufflette buse droite Anti rayures				
		166	Débit : 15 Nm³/h à 6 bar Niveau sonore : 84 dB Buse en composite haute technologie: Ø 2 x 12 mm Longueur coudée : 59 mm	27102 PRE
		-	Option soufflette avec limiteur de débit A 6 bar d'entrée, le jet d'air est équivalent à celui d'une soufflette standard avec une entrée à 3 bar.	27102 PREBP3
Soufflette à buse silencieuse				
		163	Niveau sonore : 77 dB Buse en composite, diminuant le niveau sonore Longueur coudée: 56 mm Conforme à la réglementation américaine OSHA	27102 SIL
Soufflette à écran d'air protecteur				
		168	Niveau sonore : 82 dB Buse en composite avec écran de protection Longueur coudée : 61 mm, Ø parabole 20 mm	27102 ECR
Soufflette à buse OSHA avec effet Venturi				
		176	Débit : 13 Nm³/h à 6 bar Niveau sonore : 90 dB Buse en composite Longueur coudée 69 mm Conforme à la réglementation américaine OSHA Pression dynamique à 6 bar, 10 mm de la buse: 1,2 bar	27102 OSH
Soufflette à buse longue				
		300	Buse Acier G 1/4 femelle Longueur coudée : 330 mm	27102 MB13
		460	G 1/4 femelle Longueur coudée : 500 mm	27102 MB20
Corps de soufflette adaptable				
		120	Corps de soufflette taraudé G 1/8 pour adaptation de différentes buses	27102 F18
		-	Buse longue cuivre déformable Filetée: G 1/8 - Long.: 1000 mm	27102 BL10

SOUFFLETTES 27102 EQUIPÉES D'EMBOUT

Fluide Air	Insert laiton G 1/4 - F	Poids 110 gr	Progressivité de soufflage	Pression P.N. 10 bar	Température -15 à +70°C	Matière Composite antistatique	Anti rayures	Haute résistance mécanique
---------------	----------------------------	-----------------	-------------------------------	-------------------------	----------------------------	--------------------------------------	--------------	-------------------------------

		DESIGNATION	REFERENCE
Soufflette buse métallique			
		Débit : 23 Nm³/h à 6 bar Niveau sonore : 83 dB	
		Profil ISO B Passage 6 mm	27102 MT6I
		Profil ISO C Passage 6 mm	27102 MT6C
Soufflette buse droite anti rayures			
		Débit : 15 Nm³/h à 6 bar Niveau sonore : 84 dB	
		Profil ISO B Passage 6 mm	27102 PR6I
		Profil ISO C Passage 6 mm	27102 PR6C
Soufflette à buse silencieuse			
		Niveau sonore : 77 dB	
		Profil ISO B Passage 6 mm	27102 SI6I
		Profil ISO C Passage 6 mm	27102 SI6C
Soufflette à écran d'air protecteur			
		Soufflette avec écran de protection Niveau sonore : 82 dB	
		Profil ISO B Passage 6 mm	27102 EC6I
		Profil ISO C Passage 6 mm	27102 EC6C
Soufflette à buse OSHA avec effet Venturi			
		Débit : 13 Nm³/h à 6 bar Niveau sonore : 90 dB	
		Profil ISO B Passage 6 mm	27102 OS6I
		Profil ISO C Passage 6 mm	27102 OS6C

soufflettes

SOUFFLETTES, GONFLEURS ET ACCESSOIRES DE NETTOYAGE

DES OUTILS ADAPTÉS POUR UN TRAVAIL EFFICACE

SOUFFLETTES

FORCE 3

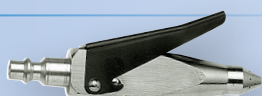

- Petite soufflette de poche, très légère, encliquetable directement sur un raccord rapide (profil 6150 ISOB)
- Soufflage droit avec écran d'air protecteur

STI



- Soufflette de poche "stylo", aluminium, 24 g, encliquetable directement sur un raccord rapide (profil 6150 ISOB)
- Réglage du jet d'air par rotation de la bague crantée

SDA



- Soufflette à déformation, antirayure, encliquetable directement sur un raccord rapide (profil 6150 ISOB)

STYL'AIR

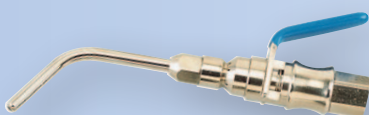

- Soufflette métallique à écran d'air, buse coudée
- 3 buses interchangeables de longueurs différentes

VENT'AIR



- Soufflette métallique forme revolver
- 4 types de soufflettes
- 6 buses adaptables

ENSEMBLES DE SOUFLAGES

Soufflettes prêtes à l'usage, montées avec un tuyau d'alimentation spiralé. Ensembles livrés, montés étanches.



GONFLAGE / NETTOYAGE

PISTOLETS DE GONFLAGE

Étalonnés CE pour véhicules légers et poids lourds.
2 modèles :

- Ajustement de la pression de gonflage par poignée
- Ajustement de la pression par touches sensibles + et -



PISTOLETS DE LAVAGE

- Pour nettoyage industriel





ASPIRATEUR PNEUMATIQUE

- Pour aspiration des poussières, copeaux, résidus de fabrication, au plus près de l'outil.

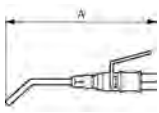

SOUFFLETTES DE POCHE

Débit 250 l/min	Encliquetable	Poids 24 g	Pression P.N. 10 bar	Matière Aluminium
		A	DESIGNATION	REFERENCE
Soufflettes de poche				
			Soufflette équipée d'un embout pour connexion sur raccord rapide	
		115	Profil ISO 6150 B Ø 6 mm	STI
		113	Profil européen 7,2	STE

SOUFFLETTES STYL'AIR

Buses Modulaires	Débit 330 l/min - 6 bar	Niveau sonore 80 db	Progressivité de soufflage	Poids 140 g	Pression Max. 10 bar	Taraudage G 1/4	Matière Acier nickelé	Sécurité Ecran d'air
		A	DESIGNATION	REFERENCE				
Soufflette métallique de sécurité								
		152	G 1/4 femelle Equipée d'une buse à écran d'air coudée de 90 mm	STL 101				
Buses coudées pour STYL'AIR								
			Buse filetage M10 x 100					
			90 mm	STL 151				
			200 mm	STL 152				
			290 mm	STL 153				

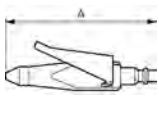

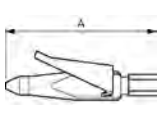

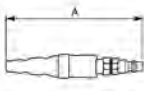

SOUFFLETTES FORCE 3

Débit 300 l/min - 6 bar	Encliquetable	Niveau sonore 80 db	Poids 85 g	Pression P.N. 16 bar	Matière Aluminium	Sécurité Ecran d'air
		A	DESIGNATION	REFERENCE		
Soufflette encliquetable avec embout ISO 6150 B						
		104	Soufflette à utiliser sur raccords ISI 06 - ISC 06 - IRC 06 - IRM 06 (profil ISO B)	FORCE 3		
Soufflette taraudée femelle						
		99	Entrée : G 1/4 femelle	FORCE 3F14		



SOUFFLETTES ANTI-RAYURES

Encliquetable	Poids 100 g	Matière Caoutchouc	Anti rayures	Pression P.S. 1 à 16 bar
		A	DESIGNATION	REFERENCE
Soufflette encliquetable avec embout				
			Soufflette à déformation anti-rayure - Soufflette équipée d'un embout pour connexion sur raccord rapide	
		128	ISI 06 - ISC 06 - IRC 06 - IRM 06 - profil ISO 6150 B	SDA 6I
		123	ESI 07 - ERC 07 - Profil européen 7,2	SDA 7E



SOUFFLETTES VENT'AIR

Débit 300 l/min - 6 bar	Pression Max.6 bar	Température -10°C +80°C	Taraudage Entrée G 1/4 femelle	Matière Corps alu Gachette métal	Anti chocs	Matière Soupape laiton Ressort acier inox	Ergonomique
		A	B	C	DESIGNATION	REFERENCE	
Soufflette buse courte							
		136			Soufflette métallique	27104	
		-			Buse courte de rechange filetage : 14 x 100	27104BUSE1	
Soufflette buse moyenne long.150 mm							
		266			Soufflette métallique	27105	
		-			Buse moyenne de rechange filetage : 14 x 100	27105BUSE1	
Soufflette extra longue Long.300mm							
		416			Soufflette métallique à buse longue G 1/4 femelle	27106	
		-			Buse longue de rechange filetage: 14 x 100	27106BUSE1	

SOUFFLETTES VENT'AIR

Débit 300 l/min - 6 bar	Pression Max.6 bar	Température -10°C +80°C	Taraudage Entrée G 1/4 femelle	Matière Corps alu Gachette métal	Anti chocs	Matière Soupape laiton Ressort acier inox	Ergonomique
		A	B	C	DESIGNATION		REFERENCE
Buses adaptables pour soufflettes Vent'Air : 27105-27106							
		54	14	-	Buse Venturi		AVB 101
		39	13	-	Buse de sécurité 2 bar maxi - (OSHA)		AVB 102
		31	25	-	Buse de sécurité à écran d'air		AVB 103
		31	-	-	Buse de protection anti-rayures		AVB 104
		40	-	-	Buse silencieuse jet directionnel - (OSHA)		AVB 105
		54	14	3100	Buse aspirante longueur 3 m avec filtre d'aspiration		AVB 106
Soufflette spéciale "haut débit"							
		186			Soufflette métallique à buse Venturi Débit sous 6 bar : 450 l/min		27113

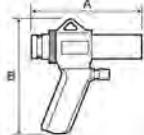
ASPIRATEUR PNEUMATIQUE "ASPIVENT"

Aspiration Dépression 80 mm de mercure à 6 bar	Débit 420 l/min / 6 bar	Entrée taraudée G 1/4 femelle	Pression P.N.7 bar	Facilité d'emploi Pratique et simple	Anti chocs	Sécurité Système de récupération
		A	B	DESIGNATION		REFERENCE
Ensemble de nettoyage par aspiration						
				Composition : - un sac de récupération en tissu - 4 litres - ASV 301 - un aspirateur pneumatique Aspivent - ASV 100 - un embout suceur - ASV 305		ASV 1
Ensemble pour endroits peu accessibles						
				Composition : - un sac de récupération en tissu - 4 litres - ASV 301 - un aspirateur pneumatique Aspivent pour cavités profondes - ASV 200		ASV 2

ASPIRATEUR PNEUMATIQUE "ASPIVENT"





Aspiration Dépression 80 mm de mercure à 6 bar	Débit 420 l/min / 6 bar	Entrée taraudée G 1/4 femelle	Pression P.N.7 bar	Facilité d'emploi Pratique et simple	Anti chocs	Sécurité Système de récupération
--	----------------------------	----------------------------------	-----------------------	---	------------	--

		A	B	DESIGNATION	REFERENCE
Pistolet de nettoyage par aspiration					
		140	145	Conçu pour le nettoyage des postes de travail par aspiration. (Prévoir système de récupération)	ASV 100
Pistolet pour endroits peu accessibles					
		220	145	Conçu pour aspirer les poussières ou liquides dans les cavités profondes. (Prévoir système de récupération).	ASV 200
Accessoires					
				Sac de récupération en tissu Contenance 4 litres	ASV 301
				Tête d'aspiration	ASV 302
				Flexible d'évacuation en polyéthylène noir Ø int. 28 mm - longueur 6 m	ASV 303
				Rallonge d'extension - Longueur 400 mm	ASV 304
				Embout suceur	ASV 305
				Brosse ronde nylon	ASV 306
				Manchon d'adaptation du flexible sur aspirateur	ASV 308
				Bidon de récupération pour grosses poussières Contenance 20 litres (utilisable sans filtre ASV 309)	ASV 307
				Filtre ASV pour récupération des poussières à adapter sur bidon d'une contenance de 60 litres	ASV 309



ENSEMBLES DE SOUFFLAGE

Pression PN 8 bar		Souplesse d'utilisation		Etanche Monté étanche			Ergonomie du poste de travail		
		Diamètre int./ ext mm	Equipé d'un raccord	Longueur Max. m	Matière Spiralé	Equipé d'un embout	Equipé d'une soufflette	Equipé d'une jonction	REFERENCE
Ensemble de soufflage : 27102 MTL et raccord rapide standard - sous coque									
	Ensemble comprenant : 1 embout IRP 066151 1 raccord IRC 061101 1 jonction JPC 1408 1 soufflette 27102 MTL								
		IRC 061101				IRP 066151	27102 MTL	JPC 1408	ERK 2
Ensemble de soufflage : 27102 PRE et raccord rapide standard - sous coque									
	Ensemble comprenant : 1 embout IRP 066151 1 raccord IRC 061101 1 jonction JPC 1408 1 soufflette 27102 PRE								
		IRC 061101				IRP 066151	27102 PRE	JPC 1408	ERK 21
Ensemble de soufflage avec STL 101 et raccord rapide standard									
	Ensemble comprenant : 1 embout IRP 066151 1 raccord IRC 061101 1 jonction JPC 1408 1 soufflette STL 101								
		IRC 061101				IRP 066151	STL 101	JPC 1408	ERK 1
Ensemble de soufflage avec STL 101 et raccord rapide sécurité									
	Ensemble comprenant : 1 embout IRP 066151 1 raccord ISI 061101 1 jonction JPC 1408 1 soufflette STL 101								
		ISI 061101				IRP 066151	STL 101	JPC 1408	ERK 11S
Ensemble avec 27102 MTL, spiralé Polyamide, raccordement fixe G 1/4 BSP									
	Ensemble comprenant : 1 spiralé polyamide G 1/4 BSP mâle 1 soufflette 27102 MTL								
	6.5 x 8	Fixe	5	Polyamide			27102 MTL		HELICOL 3
Ensemble avec spiralé et raccord rapide standard - sous coque									
	Ensemble comprenant : 1 embout IRP 066101 1 embout IRP 066151 1 raccord IRC 061101 1 soufflette 27102 MTL 1 tuyau spiralé PUS 52								
	5 x 8	IRC 061101	2	Polyuré thane	IRP 066151+ 066101	27102 MTL			ERK 3

ENSEMBLES DE SOUFFLAGE





Pression PN 8 bar		Souplesse d'utilisation		Étanche Monté étanche			Ergonomie du poste de travail		
		Diamètre int./ ext mm	Equipé d'un raccord	Longueur Max. m	Matière Spiralé	Equipé d'un embout	Equipé d'une soufflette	Equipé d'une jonction	REFERENCE
Ensemble de soufflage avec 27104, spiralé et raccord rapide standard									
	Ensemble comprenant : 1 spiralé polyuréthane 1 raccord IRC 06 et 2 embouts IRP 06 1 soufflette 27104								
	5 x 8	IRC 061101	2	Polyuréthane	IRP 066151+ 066101	27104			HELICOL 9
Ensemble avec spiralé et raccord rapide sécurité - sous coque									
	Ensemble comprenant : 1 embout IRP 066101 1 embout IRP 066151 1 raccord ISI 061101 1 soufflette 27102 MTL 1 tuyau spiralé PUS 52								
	5 x 8	ISI 061101	2	Polyuréthane	IRP 066151+ 066101	27102 MTL			ERK 3IS
Ensemble avec soufflette à déformation, raccordement fixe G 1/4 BSP									
	Ensemble comprenant : 1 spiralé polyuréthane G 1/4 BSP mâle 1 soufflette anti-rayure								
	4 x 6		4	Polyuréthane		SDA à déformation progressive			HELICOL 4
Ensemble de soufflage avec STL 101, spiralé et raccord rapide standard									
	Ensemble comprenant : 1 spiralé polyuréthane 1 raccord IRC 06 et 2 embouts IRP 06 1 soufflette STL 101								
	5 x 8	IRC 061101	2	Polyuréthane	IRP 066151+ 066101	STL 101			HELICOL 8
Ensemble de soufflage avec Force 3, spiralé et raccord rapide métal									
	Ensemble comprenant : 1 spiralé polyamide 1 raccord IRM 06 et 2 embouts IRP 06 1 soufflette FORCE 3								
	6.5 x 8	IRM 061101	4.5	Polyuréthane	IRP 066101	FORCE 3			HELICOL 1

ENSEMBLES DE SOUFFLAGE

Pression PN 8 bar		Souplesse d'utilisation		Etanche Monté étanche			Ergonomie du poste de travail		
		Diamètre int./ ext mm	Equipé d'un raccord	Longueur Max. m	Matière Spiralé	Equipé d'un embout	Equipé d'une soufflette	Equipé d'une jonction	REFERENCE
Ensemble de soufflage avec Force 3, spiralé et raccord rapide métal									
	Ensemble comprenant : 1 spiralé polyuréthane 1 raccord IRM 06 et 2 embouts IRP 06 1 soufflette FORCE 3								
	5 x 8	IRM 061101	2	Polyuréthane	IRP 066101	FORCE 3			HELICOL 2
Ensemble avec 27102 MTL, spiralé, raccordement fixe G 1/4 BSP									
	Ensemble comprenant : 1 spiralé polyuréthane G 1/4 BSP mâle 1 soufflette 27102 MTL								
	5 x 8	Fixe	2	Polyuréthane		27102 MTL			HELICOL 6
	5 x 8	Fixe	4	Polyuréthane		27102 MTL			HELICOL 7
Ensemble avec 27102 MTL, spiralé et raccord rapide de sécurité									
	Ensemble comprenant : 1 spiralé polyuréthane 1 raccord 2 embouts 1 soufflette 27102 MTL								
	5 x 8	ISI 061101	2	Polyuréthane	IRP 066101+ 066151	27102 MTL			PUS 52BIS
	5 x 8	ISI 061101	4	Polyuréthane	IRP 066151+ 066101	27102 MTL			PUS 54BIS
	5 x 8	CSI 061101	4	Polyuréthane	CRP 066101+ 066151	27102 MTL			PUS 54BCS
	6.5 x 10	ISI 061101	4	Polyuréthane	IRP 066151+ 066101	27102 MTL			PUS 64BIS
	6.5 x 10	ISI 061101	6	Polyuréthane	IRP 066151+ 066101	27102 MTL			PUS 66BIS
	6.5 x 10	CSI 061101	6	Polyuréthane	CRP 066101+ 066151	27102 MTL			PUS 66BCS
	6.5 x 10	ISI 061101	8	Polyuréthane	IRP 066151+ 066101	27102 MTL			PUS 68BIS
	6.5 x 10	CSI 061101	8	Polyuréthane	CRP 066101+ 066151	27102 MTL			PUS 68BCS

PISTOLET DE GONFLAGE

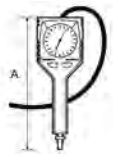
Précision Lecture facile	Anti chocs Anti rayures	Ergonomique Excellente maniabilité	Longueur L = 1,50 m
-----------------------------	----------------------------	---------------------------------------	------------------------

	A	DESIGNATION	REFERENCE
Pistolet de gonflage à poignée, modèle Eurodainu			
		<p>Pistolet de gonflage à poignée Auto, moto, PL, matériel agricole, approuvé par Michelin, homologué norme CEE, conforme à :</p> <ul style="list-style-type: none"> - directive 86/217/CEE - décret 88/78 - norme AFNOR EN R 63-302 <p>Fourni avec un certificat de garantie comportant le numéro de série du manomètre.</p>	
		240 Entrée d'air: G 1/4 femelle Pression : 0,7 à 11 bar (10 - 160 PSI) Corps en thermoplastique extra résistant Longueur du tuyau : 1,50 m	27101
Pistolet de gonflage à touches, modèle Mast'air			
		<p>Pistolet de gonflage à touche - et + Auto, moto, PL, conforme à :</p> <ul style="list-style-type: none"> - directive 86/217/CEE - décret 88/78 - norme AFNOR EN R 63-302 <p>Fourni avec un certificat de garantie comportant le numéro de série du manomètre.</p>	
		290 Raccordement : G 1/4 femelle Graduation : 0,7 à 12 bar Ø tuyau : 7 x 13 mm Longueur : 1,50 m Pression maxi d'alimentation : 15 bar	27201
Pièces détachées			
		Tuyau pour pistolet de gonflage Raccordement : Mâle Pas Michelin Longueur 1.50 m	7101T
		Tuyau pour pistolets de gonflage Raccordement : Femelle Pas Michelin Longueur 1.50 m	7200T
		Embout pour connexion valve	101V

pistolets de lavage

PISTOLETS DE LAVAGE POUR CIRCUITS D'EAU

UNE GAMME ADAPTÉE À VOS APPLICATIONS

► **Industrielles**

Nettoyage machines, cuves, lessivage sols, murs, dans les unités de transformation et de conditionnement de denrées alimentaires (fromageries, abattoirs, brasseries, conserveries...) et toutes les industries nécessitant lavages ou arrosages fréquents.

► **Automobiles**

Lavage carrosserie, nettoyage châssis, accessoires, machines... dans les garages, les carrosseries, les travaux publics, les exploitations agricoles...

► **Collectivités**

Lessivage, entretien, arrosage dans les grandes surfaces, restaurants, écoles, bâtiments publics, jardins...

► **Voirie**

Lavage, arrosage sur la voie publique: trottoirs, rues piétonnes, bassins, fontaines, jardins publics, massifs de fleurs...





PL JET

PISTOLET DE LAVAGE INDUSTRIEL

► Débit réglable

Débit d'eau réglable par vis, à l'arrière, pour moduler le débit et diminuer la consommation.

► Étanchéité

Le mécanisme est simple et sûr. Double joint sur l'aiguille pour une étanchéité totale.

► Sécurité

L'arceau empêche toute manipulation involontaire. Un gainage polyamide recouvre corps, levier et arceau pour une isolation thermique et une protection en cas de choc.

► Souplesse

La progressivité du levier permet d'obtenir toutes les formes de jet entre une pulvérisation conique large et un jet droit concentré et puissant.

► Efficacité

Le crochet permet de maintenir le levier en position ouverte pour les longues utilisations. Son déblocage est automatique.

► Antirayures

Les trois extrémités renflées sont gainées de caoutchouc, ce qui évite tous risques de rayures sur les surfaces fragiles.

► Ergonomie

L'excellente tenue en main permet un travail régulier et sans fatigue.

► Design

Les formes arrondies du corps et de la poignée évitent l'encrassement et facilitent l'entretien.



PL JET I

PISTOLET DE LAVAGE ACIER INOX

► Acier Inox 316

Résistance à la corrosion. Utilisation recommandée pour les industries agro-alimentaires et portuaires (ambiances salines et agressives).

► Maniabilité

Bonne tenue en main. Le crochet permet de maintenir le levier en position ouverte pour les utilisations prolongées.

► Sécurité

Une flèche indique le sens du jet d'eau. Un gainage caoutchouc EPDM assure isolation et protection.

► Débit réglable

► Souplesse du levier

► Étanchéité





Avantages identiques au modèle PL JET.

CARACTÉRISTIQUES TECHNIQUES COMMUNES PL JET et PL JET I

- Température maxi: + 90°C
- Pression maxi:24 bar
- Poids: 950 g
- Débit: 60 l/min à 20 bar
..... 43 l/min à 10 bar
- Taraudage: G 1/2 BSP

PISTOLETS DE LAVAGE

Applications multiples Industrie et réparation automobile	Collectivité voirie Nettoyage, arrosage	Débit d'eau réglable	Fluide Eau	Ergonomie Bonne tenue en main
---	--	----------------------	---------------	----------------------------------

		A	B	DESIGNATION	REFERENCE
Pistolet de lavage industriel					
				Pistolet de lavage équipé d'un arceau de protection de la gâchette Température maxi : +90°C Pression maxi : 24 bar Poids : 950 g Débit : 60 l/min à 20 bar; 43 l/min à 10 bar	
		162	216	Pistolet de lavage gainé polyamide Taraudage : G 1/2	PL JET
Pistolet de lavage industriel acier inox 316					
				Pistolet de lavage Inox 316 gainé caoutchouc EPDM Arceau protection de la gâchette Température maxi: 90°C Pression maxi: 24 bar Poids: 950 g Débit: 60 l/min à 20 bar; 43 l/min à 10 bar	
		159	189	Pistolet de lavage inox Taraudage: G 1/2	PL JET1

PISTOLETS DE LAVAGE

Applications multiples Industrie et réparation automobile	Collectivité voirie Nettoyage, arrosage	Débit d'eau réglable	Fluide Eau	Ergonomie Bonne tenue en main
---	---	----------------------	----------------------	---

		A	B	DESIGNATION	REFERENCE
Pistolet PL JET avec raccord pour tuyau					
				Ensemble comprenant : 1 pistolet de lavage industriel 1 raccord à obturation 1 embout mâle G 1/2 1 collier de serrage Pour tuyaux :	PL JET15
				Ø 15 mm	

PULVERISATEUR

Décapage - nettoyage Automobile, industrie	Progressivité Réglage progressif	Pression 2 - 8 bar	Matière Bol aluminium Contenance: 1 l	Facilité d'emploi
--	--	------------------------------	---	-------------------

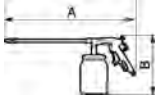
		A	B	DESIGNATION	REFERENCE
Pistolet pulvérisateur : nettoyage					
		520	225	Pistolet pulvérisateur Jet réglable par le nez de la buse Longueur de buse 20 cm en laiton nickelé Bol aluminium - Contenance : 1 l Entrée d'air : G 1/4 mâle	27103

peinture

PISTOLETS DE PEINTURE STANDARD, HVLP
ET SÉCHAGE DES PEINTURES HYDROSOLUBLES

**UNE GAMME DE PISTOLETS
HAUTE PRÉCISION ET UN SYSTÈME DE
SÉCHAGE PAR SOUFFLAGE PERFORMANT**





PISTOLETS DE PEINTURE

► Pulvérisation basse pression HVLP :

Parfaite qualité de finition et haut rendement

- Excellent taux de transfert produit
- Réduction du brouillard
- Economie de produit
- Précision d'application

► Pulvérisation standard :

Grande facilité d'utilisation pour applications usuelles

- Usage courant industriel ou artisanal

► Alimentation peinture :

Suivant la quantité nécessaire et la structure de la peinture

- Alimentation par aspiration
- Alimentation par gravité

► Choix de la buse de pulvérisation :

En fonction de la viscosité du produit à pulvériser (laque, vernis, apprêts, colles), le peintre choisira la buse adaptée à l'usage.

Large gamme de buses :
de 0,5 mm à 2,5 mm selon les modèles de pistolets.

SÉCHAGE DES PEINTURES

Séchage des peintures à l'eau par soufflage

► Avantages :

- Evaporation rapide de l'eau contenue dans la peinture
- Accélération du temps de séchage des peintures
- Gain de temps de séchage en cabine de peinture
- Efficacité des pistolets accrue par un effet venturi
- Filtration de l'air venturi par tamis inox amovible (bague de maintien)
- Pistolets fournis avec vanne à boisseau sphérique permettant la régulation du soufflage

► Module de séchage :

- Hauteur du support ajustable, horizontalement et verticalement, selon les surfaces à sécher
- Support léger et stable
- Orientation aisée des pistolets de séchage
- Alimentation des pistolets par tuyaux antistatiques Ø 10 mm int. pour un débit d'air de soufflage optimum

► Module de séchage sur pied équipé de :





- 2 pistolets de séchage avec vanne d'arrêt
- 2 tuyaux caoutchouc antistatique Ø 10 mm
- 2 raccords rapides d'alimentation
- 1 embout d'arrivée d'air

Prévoir la filtration de l'air comprimé en amont par un ensemble de filtration submicronique **MICRO AIR**.









PISTOLETS DE PEINTURE HVLP BASSE PRESSION





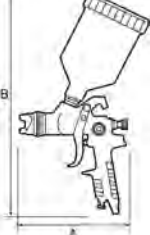

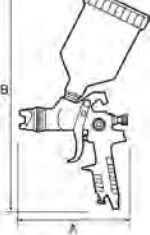



Efficacité Transfert produit	Economique Maîtrise du débit de peinture	Réglage simple	Matière Aluminium	Application
---------------------------------	---	-------------------	----------------------	-------------

		A	B	DESIGNATION	REFERENCE
Pistolet de peinture HVLP par aspiration					
				Réglage de répartition de peinture Réglage du débit de peinture Réglage du débit d'air comprimé Corps en aluminium vert anodisé Godet 1 litre en aluminium par oxydation anodique Godet à fermeture rapide par étrier, anti goutte Buse et aiguille acier inoxydable Plage de pression pour une pulvérisation optimum : 2 à 3 bar Débit d'air : 390 l/min sous 3 bar Poids : 1,00 kg Raccordement : G 1/4 BSP mâle Raccordement au godet : G 3/8 BSP	
		16	30	Buse Ø 1,7 mm	CAR S03HVLP
		16	30	Buse Ø 1 mm	CAR S031HVLP
		16	30	Buse Ø 1,4 mm	CAR S032HVLP
		16	30	Buse Ø 2 mm	CAR S033HVLP
		16	30	Buse Ø 2,3 mm	CAR S034HVLP
Pistolet de peinture HVLP par gravité					
				Réglage de répartition de peinture par bouton moleté Réglage du débit de peinture Réglage du débit d'air comprimé Buse et aiguille acier inoxydable Corps en aluminium vert anodisé Godet 0,6 litre en polyamide Plage de pression pour une pulvérisation optimum : 1 à 3,5 bar Débit d'air : 225 l/min sous 3 bar Poids : 0,7 kg Raccordement : G 1/4 BSP mâle Raccordement au godet : M16 x 1,5 P	
		16	33	Buse Ø 1,4 mm	CAR G04HVLP
		16	33	Buse Ø 1 mm	CAR G041HVLP
		16	33	Buse Ø 1,5 mm	CAR G042HVLP
		16	33	Buse Ø 1,7 mm	CAR G043HVLP
		16	33	Buse Ø 2 mm	CAR G044HVLP









PISTOLETS DE PEINTURE STANDARDS

Efficacité	Poids	Réglage simple	Matière Aluminium anodisé bleu	Utilisation peinture	Application automobile et industrie
Pistolet de peinture par aspiration pour travaux techniques					
				Réglage de répartition de peinture Réglage du débit de peinture Réglage du débit d'air comprimé Godet 1 litre en aluminium par oxydation anodique Godet à fermeture rapide par étrier, anti goutte Aiguille acier inoxydable Pression de service : 3,5 bar à 5 bar Poids : 0,95 kg - Débit d'air : 260 à 340 l/min Raccordement : G 1/4 BSP mâle Raccordement au godet : G 3/8 BSP	
		16	29	Buse Ø 2 mm en acier inoxydable	CAR S03
		16	29	Buse Ø 1,5 mm en acier inoxydable	CAR S031
		16	29	Buse Ø 2,5 mm en acier inoxydable	CAR S032
Pistolet de peinture par aspiration pour travaux industriels					
				Réglage de répartition de peinture Réglage du débit de peinture Godet 1 litre en aluminium par oxydation anodique Aiguille acier inoxydable Godet à fermeture rapide par étrier, anti goutte Poids : 1,1 kg - Pression de service : 3,5 bar à 5 bar Raccordement : G 1/4 BSP Débit d'air : 280 à 360 l/min sous 3 bar Raccordement au godet : G 3/8 BSP	
		16	30	Buse Ø 1,6 mm en acier	CAR S02
		16	30	Buse Ø 1 mm en acier	CAR S021
		16	30	Buse Ø 1,8 mm en acier	CAR S022
16	30	Buse Ø 2 mm en acier	CAR S023		
Pistolet de peinture par gravité pour travaux techniques					
				Réglage de répartition de peinture Réglage du débit de peinture Godet 0,6 litre en polyamide Réglage du débit d'air comprimé Pression de service : 3,5 bar à 5 bar Aiguille acier inoxydable Débit d'air : 250 à 320 l/min - Poids : 0,6 kg Raccordement : G 1/4 BSP	
		16	32.5	Buse Ø 1,4 mm en acier inoxydable	CAR G04
		16	32.5	Buse Ø 1,7 mm en acier inoxydable	CAR G041
16	32.5	Buse Ø 2 mm en acier inoxydable	CAR G042		
Pistolet de peinture pour retouche carrosserie vernissage travaux de décoration					
				Réglage de répartition de peinture par bouton moleté Réglage du débit de peinture Godet 0,125 litre en polyamide Réglage du débit d'air comprimé Pression de service : 2,6 bar à 4 bar Débit d'air : 85 à 140 l/min - Poids : 0,3 kg Raccordement : G 1/4 BSP	
		10	24.5	Buse Ø 0,8 mm en acier inoxydable	CAR G05
		10	24.5	Buse Ø 0,5 mm en acier inoxydable	CAR G051
10	24.5	Buse 1 mm en acier inoxydable	CAR G052		

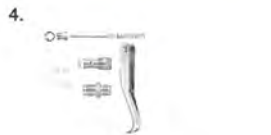









PIECES DETACHEES POUR PISTOLETS DE PEINTURE

		DESIGNATION	REFERENCE
Pièces détachées pour pistolet de peinture CAR S03HVLP			
		1. Buse Ø 1.0 mm	CAR S03B10HVLP
		1. Buse Ø 1.4 mm	CAR S03B14HVLP
		1. Buse Ø 1.7 mm	CAR S03B17HVLP
		1. Buse Ø 2.0 mm	CAR S03B20HVLP
		1. Buse Ø 2.3 mm	CAR S03B23HVLP
	2. Kit complet buse Ø 1,7 mm + vis de réglage du débit de peinture	CAR S03HVLPK1	
	3. Kit de réglage de la forme du jet	CAR S03HVLPK3	
	4. Kit gâchette + mécanisme complet	CAR S03HVLPK4	
	5. Kit de débit d'air + écrou pour embout d'air	CAR S03HVLPK5	
Pièces détachées pour pistolet de peinture CAR S03			
		1. Buse Ø 1,5 mm	CAR S03B15
		1. Buse Ø 2.0 mm	CAR S03B20
		1. Buse Ø 2.5 mm	CAR S03B25
		2. Kit complet buse Ø 2 mm + vis de réglage du débit de peinture	CAR S03K1
		3. Kit de réglage de la forme du jet	CAR S03K3
	4. Kit gâchette + mécanisme complet	CAR S03K4	
	5. Kit de débit d'air + écrou pour embout d'air	CAR S03K5	
			



PIECES DETACHEES POUR PISTOLETS DE PEINTURE

		DESIGNATION	REFERENCE	
Pièces détachées pour pistolet de peinture CAR S02				
 <p>1.</p>		1. Buse Ø 1,0 mm	CAR S02B10	
		1. Buse Ø 1.6 mm	CAR S02B16	
		1. Buse Ø 1.8 mm	CAR S02B18	
		1. Buse Ø 2.0 mm	CAR S02B20	
	 <p>2.</p>		2. Kit complet buse Ø 1,6 mm + vis de réglage du débit de peinture	CAR S02K1
			3. Kit de réglage de la forme du jet	CAR S02K3
 <p>3.</p>				
 <p>4.</p>		4. Kit gâchette + mécanisme complet + écrou pour embout d'air	CAR S02K4	
Pièces détachées pour pistolet de peinture CAR G04HVLP				
 <p>1.</p>		1. Buse Ø 1.0 mm	CAR G04B10HVLP	
		1. Buse Ø 1.4 mm	CAR G04B14HVLP	
		1. Buse Ø 1.5 mm	CAR G04B15HVLP	
		1. Buse Ø 1.7 mm	CAR G04B17HVLP	
		1. Buse Ø 2.0 mm	CAR G04B20HVLP	
 <p>2.</p>		2. Kit complet buse Ø 1,4 mm HVLP + vis de réglage de débit de peinture	CAR G04HVLPK1	
		3. Kit de réglage de la forme du jet	CAR G04HVLPK3	
 <p>3.</p>				
 <p>4.</p>		4. Kit gâchette + mécanisme complet pour CAR G04HVLP et CAR G04	CAR G04K4	
		5. Kit de débit d'air + écrou pour embout d'air	CAR G04HVLPK5	
 <p>5.</p>				

PIECES DETACHEES POUR PISTOLETS DE PEINTURE



		DESIGNATION	REFERENCE
Pièces détachées pour pistolet de peinture CAR G04			
 1.		1. Projecteur 1.4 mm	CAR G04B14
	 2.	1. Projecteur 1.7 mm	CAR G04B17
		1. Projecteur 2.0 mm	CAR G04B20
	 3.	2. Kit complet buse Ø 1,4 mm + vis de réglage du débit de peinture	CAR G04K1
	 4.	3. Kit de réglage de la forme du jet	CAR G04K3
 5.	4. Kit gâchette + mécanisme complet pour CAR G04HVLP et CAR G04	CAR G04K4	
		5. Kit de débit d'air + écrou pour embout d'air	CAR G04K5
Pièces détachées pour pistolet de peinture CAR G05			
 1.		1. Buse Ø 0.5 mm	CAR G05B05
	 2.	1. Buse Ø 0.8 mm	CAR G05B08
		1. Buse Ø 1.0 mm	CAR G05B10
	 3.	2. Kit complet buse Ø 0,8 mm + vis de réglage du débit de peinture	CAR G05K1
	 4.	3. Kit réglage de la forme du jet	CAR G05K3
 5.	4. Kit gâchette + mécanisme complet	CAR G05K4	
		5. Kit de débit d'air + écrou pour embout d'air	CAR G05K5

PIECES DETACHÉES POUR PISTOLETS DE PEINTURE

		DESIGNATION	REFERENCE
Kit godet pour pistolets de peinture par aspiration			
		Kit godet pour pistolet CAR S03HVLP	CAR S03HVLPK2
		Kit godet pour pistolets CAR S02 et CAR S03	CAR S02K2
Kit godet pour pistolets de peinture par gravité			
		Kit godet pour pistolets CAR G04 HVLP et CAR G04	CAR G04K2
		Kit godet pour pistolet CAR G05	CAR G05K2
Kit d'entretien			
		Kit d'entretien pour pistolets CAR S03HVLP et CAR S03	CAR S03KEN
		Kit d'entretien pour pistolet CAR S02	CAR S02KEN
		Kit d'entretien pour pistolets CAR G04HVLP et CAR G04	CAR G04KEN
		Kit d'entretien pour pistolet CAR G05	CAR G05KEN

SECHAGE DES PEINTURES HYDROSOLUBLES

Utilisation Séchage des peintures à l'eau	Réglage simple	Pression Max. 12 bar	Température -20°C + 80°C	Economique Gain de temps de séchage	Efficacité Evaporation rapide de l'eau
--	----------------	-------------------------	-----------------------------	--	---

		DESIGNATION	REFERENCE
Pistolet de séchage			
		<p>Filetage mâle G 1/4 Pression d'utilisation: 2 à 4 bar Consommation: 350 l/min à 4 bar Distance de soufflage: 40/50 cm Corps: aluminium Poignée: nylon Poids: 0,46 kg</p>	CAR DP
Module de séchage sans pistolets			
		<p>Orientation des pistolets : 360° Pression d'utilisation : 2 - 4 bar Matière : acier Poids : 8 kg Largeur entre les pistolets : ajustable de 0,1 à 0,9 m Hauteur de soufflage : ajustable de 0 à 2 m Longueur des pieds : 0,5 m</p>	
		Module de séchage identique au CAR MDE sans les pistolets	CAR MES
Module de séchage avec pistolets			
		<p>Orientation des pistolets : 360° Pression d'utilisation : 2 - 4 bar Matière : acier Poids : 8 kg Largeur entre les pistolets : ajustable de 0,1 à 0,9 m Hauteur de soufflage : ajustable de 0 à 2 m Longueur des pieds : 0,5 m</p>	
		<p>Module de séchage équipé de :</p> <p>Entrée :</p> <ul style="list-style-type: none"> - 1 embout pour raccord rapide - Profil 7,2 mm <p>Sortie :</p> <ul style="list-style-type: none"> - 2 raccords rapides profil 7,2 mm avec embouts - 2 pistolets de séchage CAR DP 	CAR MDES

LA GAMME DES OUTILS PNEUMATIQUES PREVOST

UNE SÉLECTION IMPORTANTE POUR TRAVAUX COURANTS
ET SPÉCIALISÉS

► **Performance**

Des outils conformes aux besoins des utilisateurs: énergie, puissance, vitesse, progressivité, contrôle, précision, robustesse, sécurité.

► **Gamme**

Une sélection très pointue: de la perceuse universelle tous travaux, à la clé à choc haut de gamme pour utilisation intensive.

► **Applications**

De vastes domaines d'utilisation: garages, poids lourds, centres auto, carrosseries, maintenance, mécanique, tôlerie, chaudronnerie, industrie, assemblage, artisanat, travaux de série ou ponctuels.

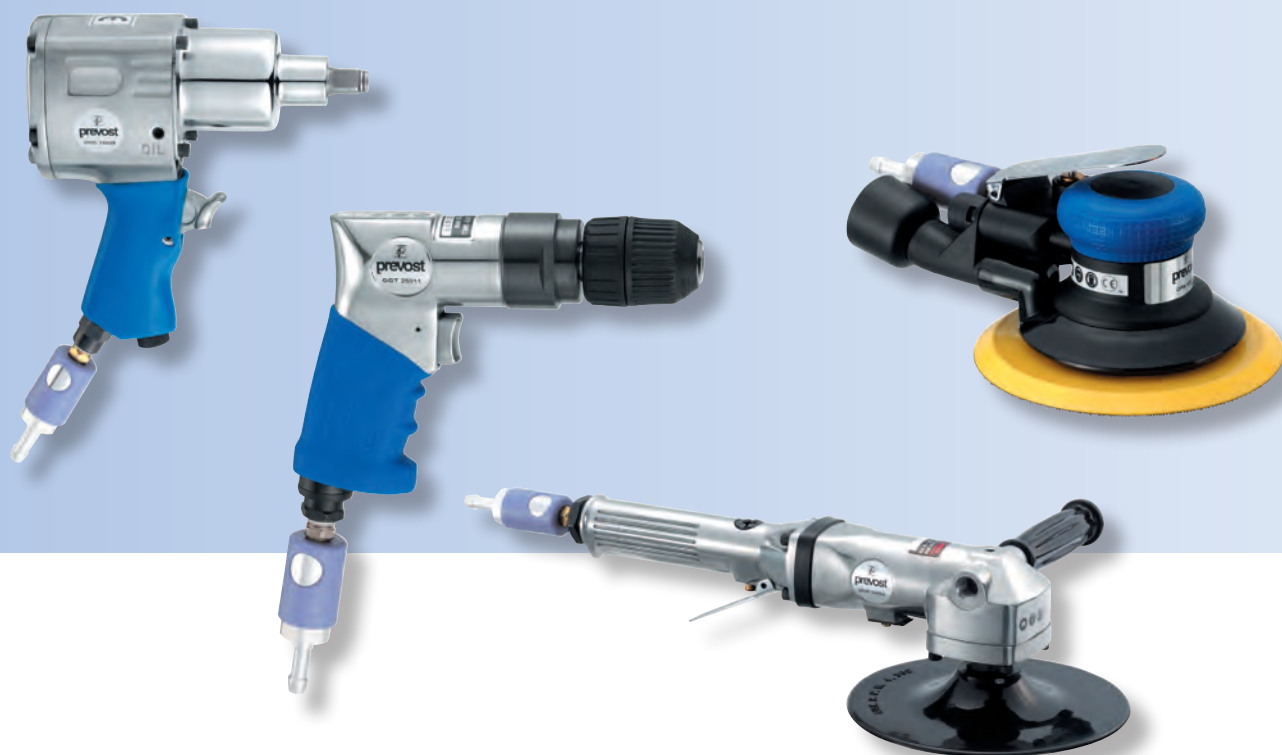

		AVANTAGES	APPLICATIONS
	<p>> SERRAGE</p> <ul style="list-style-type: none"> - Clés à cliquet standard - Clé à cliquet modèle lourd - Clés à chocs G 3/8, G 1/2, G 3/4 et G 1 modèles universels et industriels 	<ul style="list-style-type: none"> - Rapport couple/poids optimum - Energie maximale pour un encombrement réduit - Bonne prise en main - Carter de frappe acier - Robustesse - Efficacité 	<ul style="list-style-type: none"> - Maintenance, entretien - Serrage en série - Travaux publics - Engins de chantier et agricoles - Ateliers poids lourds et carrosserie
	<p>> MEULAGE</p> <ul style="list-style-type: none"> - Mini-meuleuse crayon - Meuleuses en composite : haute et basse vitesse - Meuleuses à renvoi d'angle : avec pince de 6 mm ou meule Ø 125 mm - Meuleuse haut rendement 15 000 tours - Meuleuse verticale - Tronçonneuse-meuleuse 	<ul style="list-style-type: none"> - Confort d'utilisation - Gâchette de sécurité évitant les démarrages accidentels - Outils précis et sûrs 	<ul style="list-style-type: none"> - Travaux de façonnage et de rectification - Travaux de brossage, décapage, ébarbage, dressage, tronçonnage, en carrosserie, métallerie, maintenance industrielle et chaudronnerie
	<p>> DISQUAGE</p> <ul style="list-style-type: none"> - Disqueuse revolver Ø 125 mm - Disqueuse à renvoi d'angle Ø 180 mm 	<ul style="list-style-type: none"> - Maniabilité - Puissance - Polyvalence (en fonction des plateaux utilisés) 	<ul style="list-style-type: none"> - Carrosserie automobile et industrielle - Serrurerie
	<p>> BURINAGE</p> <ul style="list-style-type: none"> - Marteau burineur - Pistolet décapeur à aiguilles 	<ul style="list-style-type: none"> - Outils ergonomiques à très bon rendement - Confort d'utilisation 	<ul style="list-style-type: none"> - Découpage tôle et matériaux divers - Décapage de surfaces (peinture, rouille, laitier de soudure) - Dépolissage - Mécanique, carrosserie et bâtiment
	<p>> PONÇAGE</p> <ul style="list-style-type: none"> - Ponceuses orbitales - Ponceuses à bande 	<ul style="list-style-type: none"> - Machines légères et équilibrées - Roulement de haute qualité - Régulateur de vitesse incorporé 	<ul style="list-style-type: none"> - Travaux de préparation et de carrosserie.

		AVANTAGES	APPLICATIONS
	> POLISSAGE		
	<ul style="list-style-type: none"> - Polisseuse verticale Ø 180 mm 	<ul style="list-style-type: none"> - Outil polyvalent - Vitesse réglable et puissance adaptée - Excellente prise en main - Travaux précis 	<ul style="list-style-type: none"> - Travaux de disquage avec plateaux semi rigides, travaux de polissage et lustrage avec plateaux mousse et laine
	> PERÇAGE		
	<ul style="list-style-type: none"> - Perceuse revolver Ø 10 mm - Perceuse revolver réversible Ø 10 mm - Perceuse revolver réversible Ø 13 mm - Perceuse à renvoi d'angle réversible Ø 10 mm 	<ul style="list-style-type: none"> - Excellente prise en main - Gâchette progressive permettant des démarrages précis avec un contrôle parfait de la vitesse de rotation 	<ul style="list-style-type: none"> - Perçage tous matériaux avec forêt adapté
	> VISSAGE		
	<ul style="list-style-type: none"> - Visseuse composite pré réglée 800 tr/min - Visseuse composite pré réglée 1 800 tr/min - Visseuse droite pour utilisation industrielle 	<ul style="list-style-type: none"> - Outils ergonomiques et précis - Gâchette progressive - Embrayage par pression - Débrayage automatique au couple maximum 	<ul style="list-style-type: none"> - Vissages répétitifs ou non
	> RIVETAGE		
	<ul style="list-style-type: none"> - Riveteuse hydropneumatique jusqu'à 4,8 mm Poussée 720 kg - Riveteuse hydropneumatique jusqu'à 6,3 mm Poussée 1 800 kg équipée d'un récupérateur de clous de rivet 	<ul style="list-style-type: none"> - Faible encombrement - Maniabilité - Puissance exceptionnelle du modèle 1 800 kg 	<ul style="list-style-type: none"> - Utilisation en garage ou atelier de maintenance pour le modèle 720 kg - Utilisation intensive pour le modèle 1 800 kg
	> OUTILS SPÉCIFIQUES		
	<ul style="list-style-type: none"> - Scie droite universelle - Crayon graveur - Pistolet à extruder 	<ul style="list-style-type: none"> - Des outils indispensables pour un travail efficace 	

OUTILS PNEUMATIQUES

CLÉS À CLIQUET - CLÉS À CHOCS

Serrage Puissance importante		Livré avec un embout Profil ISO B		Livré avec un embout Profil 7,2 pour raccordement rapide		Efficacité		Longévité		Ergonomie Bonne prise en main	
		A	B	Niveau sonore db	Poids kg	Pression bar	Consommation l/min	Carré conducteur	Vitesse de rotation tr/min	Couple de serrage Nm	REFERENCE
Clé à cliquet réversible G 1/2 standard											
		265	62	89	1.15	6	110	1/2"	150	60	OCQ 15011
Clé idéale pour les accès difficiles Gâchette progressive permettant un contrôle parfait de la vitesse d'approche Tête renforcée en acier haute résistance Confort d'utilisation Echappement sur l'avant Rayon de passage de la tête : 20 mm											
Clé à cliquet réversible G 1/2 modèle lourd											
		360	55	89	1.75	6.5	140	1/2"	150	140	OCQ 35117
Outil d'approche idéal et adapté à la mécanique lourde, agraire et poids lourds. Couple exceptionnel 140 Nm Gâchette progressive permettant un contrôle parfait de la vitesse d'approche. Tête renforcée en acier haute résistance Utilisation possible de douilles standards Rayon de passage de la tête : 25 mm											
Clé à chocs droite G 3/8											
		160	88	85	1	6	85	3/8"	10 000	100	OCC 25010
Clé compacte et ultra légère parfaite pour les accès difficiles. Conçue pour intervention sur vis et écrou de 8 à 19 mm. Inverseur serrage/desserrage 1 main. Frappe simple marteau. Régulateur multi positions incorporé permettant d'adapter parfaitement la puissance de la machine.											
Clé à chocs droite G 3/8 en coffret											
		160	88	85	1	6	85	3/8"	10 000	100	OCC 25010C
Caractéristiques identiques à la clé OCC 25010 Livré en coffret avec : 8 douilles à chocs 3/8" courtes 8/10/11/12/13/14/17/19 mm 1 allonge longueur 75 mm 1 porte embout 5/16"											

OUTILS PNEUMATIQUES

CLÉS À CLIQUET - CLÉS À CHOCS

Serrage Puissance importante		Livré avec un embout Profil ISO B		Livré avec un embout Profil 7,2 pour raccordement rapide		Efficacité		Longévité		Ergonomie Bonne prise en main	
		A	B	Niveau sonore db	Poids kg	Pression bar	Consommation l/min	Carré conducteur	Vitesse de rotation tr/min	Couple de serrage Nm	REFERENCE
Clé à chocs G 1/2 universelle											
				Outil maniable parfaitement adapté pour tous les travaux d'entretien et de maintenance Poignée gainée offrant une parfaite ergonomie et un grand confort de travail Carter de frappe acier Inverseur "Tiroir" Puissance ajustable dans le sens de vissage et de dévissage par molette Frappe à aiguille type Dynapac							
		194	204	85	2.8	6	280	1/2"	7200	480	OCC 15028
Clé à chocs G 1/2 universelle en coffret											
				Caractéristiques identiques à la clé OCC 15028 Livré en coffret avec: les accessoires supplémentaires ci-dessous: 10 douilles 1/2" à chocs courtes (9,10,11,13,14,17,19,22,24,27) 1 allonge - longueur 175 mm 1 mini huileur 1 burette d'huile							
		194	204	85	5	6	280	1/2"	7200	480	OCC 15028C
Clé à chocs composite G 1/2 pour usage intensif											
				Outil conçu pour les conditions d'utilisation extrême Carter moteur en composite offrant : légèreté, ergonomie, confort de travail, résistance aux chocs accrue Carter de frappe acier renforcé Inverseur et régulateur combinés Puissance régulée au serrage en 3 positions : 0 à 90 N/m - 90 à 400 N/m - 400 à 585 N/m Pleine puissance au desserrage : 900 N/m Frappe à doubles marteaux longitudinaux Echappement canalisé dans la poignée avec dispositif de réduction sonore							
		178	204	83	1.9	6.5	280	1/2"	7000	900	OCC 46019
Clé à chocs composite G 1/2 pour usage intensif en coffret											
				Caractéristiques identiques à la clé OCC 46019 Livré en coffret avec les accessoires supplémentaires ci-dessous: 10 douilles G 1/2 à chocs courtes (9,10,11,13,14,17,19,22,24,27) 1 rallonge longueur 175 mm 1 mini huileur 1 burette d'huile							
		178	204	83	1.9	6.5	280	1/2"	7000	900	OCC 46019C

OUTILS PNEUMATIQUES

CLÉS À CLIQUET - CLÉS À CHOCS

Serrage Puissance importante		Livré avec un embout Profil ISO B		Livré avec un embout Profil 7,2 pour raccordement rapide		Efficacité		Longévité		Ergonomie Bonne prise en main	
		A	B	Niveau sonore db	Poids kg	Pression bar	Consom- mation l/min	Carré conducteur	Vitesse de rotation tr/min	Couple de serrage Nm	REFERENCE
Clé à chocs G 3/4 universelle											
		245	225	85	5	7	300	3/4"	5000	1000	OCC 15050
<p>Outil maniable parfaitement adapté pour tous les travaux d'entretien et de maintenance industrielle</p> <p>Carter de frappe acier renforcé</p> <p>Inverseur "Tiroir "</p> <p>Puissance ajustable dans le sens de vissage et de dévissage</p> <p>Frappe à aiguille type Dynapac</p>											
Clé à chocs G 3/4 universelle en coffret											
		245	225	85	10	7	300	3/4"	5000	1000	OCC 15050C
<p>Caractéristiques identiques à la clé OCC 15050</p> <p>Livré en coffret avec:</p> <p>les accessoires supplémentaires ci-dessous:</p> <p>8 douilles G 3/4 à chocs courtes (24,27,29,30,32,33,34,36)</p> <p>1 burette d'huile</p>											
Clé à chocs G 1 - modèle industriel											
		300	260	88	8.9	7	600	1"	3500	2450	OCC 45089
<p>Clé conçue pour la maintenance industrielle et mécanique lourde.</p> <p>Puissance exceptionnelle</p> <p>Poignée orientable intégrée</p> <p>Carter de frappe acier renforcé</p> <p>Frappe double marteaux</p> <p>Inverseur régulateur combiné</p> <p>Echappement inférieur, canalisé dans la poignée</p> <p>Excellent rapport poids/puissance : 2 450 Nm</p>											







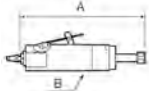

OUTILS PNEUMATIQUES

MEULEUSES

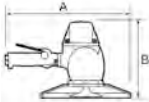

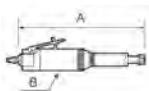
Livré avec un embout Profil ISO B		Livré avec un embout Profil 7,2 pour raccordement rapide		Sécurité Gâchette de sécurité		Pression 6.5 bar		Confort d'utilisation			
		A	B	Diamètre pince mm	Niveau sonore dB	Poids kg	Pression d'entrée	Consom- mation l/min	Vitesse de rotation tr/min	Diamètre corps	REFERENCE
Mini-meuleuse crayon											
		158	19	3	78	0,35	6	100	60 000		OMC 15003
Meuleuse composite droite : 22 000 tours/mn											
		170	40	6 ou 3	93	0.80	6.5	160	22 000		OMD 36005
Meuleuse 22 000 tr/mn en coffret avec pince de 6 mm et assortiment de meules sur tige											
		170	40	6 ou 3	93	1	6,5	160	22 000		OMD 36005C
Meuleuse confort à renvoi d'angle 22 000 tr/mn pince 6 mm											
		155	75	6	85	0,45	6	160	22 000		OMG 35004

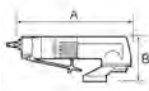
OUTILS PNEUMATIQUES

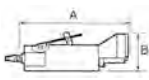
MEULEUSES

Livré avec un embout Profil ISO B		Livré avec un embout Profil 7,2 pour raccordement rapide		Sécurité Gâchette de sécurité			Pression 6.5 bar		Confort d'utilisation		
		A	B	Diamètre pince mm	Niveau sonore dB	Poids kg	Pression d'entrée	Consom- mation l/min	Vitesse de rotation tr/min	Diamètre corps	REFERENCE
Meuleuse composite droite basse vitesse : 4500 tours/min											
		210	60	6	82	0.75	6.5	180	4500		OMD 26007
Meuleuse verticale Ø 230 mm											
		300	280	230 x 22,2	79	5,8	7	2 800	5 900		OMV 35058
Meuleuse haut rendement : 15000 tours/min											
		210	60	6	82	1.30	6.5	250	1500		OMD 45013
Meuleuse à renvoi d'angle: Ø 125 mm											
		225	90	meule 125 mm	82	1.8	6.5	300	1100		OMG 35018
Tronçonneuse composite Ø 75 mm											
		188	65	76	82	0,90	6,5	160	20 000	40	OMN 35009

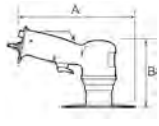
OUTILS PNEUMATIQUES DISQUEUSES

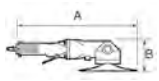
Efficacité	Livré avec un embout Profil ISO B	Livré avec un embout Profil 7,2 pour raccordement rapide	Pression 6.5 bar	Réglage Régulateur incorporé									
					A	B	Vitesse de rotation tr/min	Poids kg	Pression d'entrée	Diamètre plateau mm	Consom- mation l/min	Niveau sonore dB	REFERENCE
Disqueuse révolver: Ø 125 mm													
		Outil universel de disquage, idéal pour la mise à nue des tôles. Utilisation de disques abrasifs en fibre Ø 125 mm Régulateur incorporé											
		205	125	1800	1.15	6.5	125	170	8	ODR 25011			
Disqueuse à renvoi d'angle 180 mm													
		Outil de disquage maniable et puissant permettant d'effectuer tout type d'opération de disquage avec un rendement optimum. Idéale pour la mise à nue des tôles Régulateur incorporé - Poignée auxiliaire droite ou gauche											
		380	105	4500	2.3	6.5	180	250	86	ODR 35023			

OUTILS PNEUMATIQUES BURINEURS PISTOLETS DECAPEURS

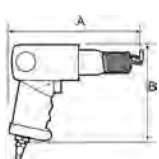
Livré avec un embout Profil ISO B	Livré avec un embout Profil 7,2 pour raccordement rapide	Applications industrielles	Pression P.N. 6.5 bar	Confort d'utilisation	Cadence de frappe 3 000 c/min	Excellent rendement										
							A	B	Poids kg	Course piston mm	Pression d'entrée	Niveau sonore dB	Cadence de frappe C/min	Consom- mation l/min	Cadence de frappe C/min	REFERENCE
Marteau burineur universel en coffret																
		Marteau conçu pour la mécanique, la carrosserie et le bâtiment. Outil ergonomique offrant un bon confort de travail (isolation du froid et amortissement des vibrations) Puissance contrôlée par gâchette progressive Régulateur incorporé - Emmanchement rond Ø 10.2 mm Livré en coffret avec: Ressort de retenue Burin classique long. 180 mm - largeur 20 mm Poinçon - Burin coupe rivet et point de soudure Burin découpeur de panneau - Burin découpeur d'échappement														
		190	150	1,65	100	6.5	93	3000	220		OBM 26016C					

OUTILS PNEUMATIQUES

BURINEURS

PISTOLETS DECAPEURS

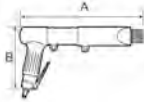

Livré avec un embout Profil ISO B	Livré avec un embout Profil 7,2 pour raccordement rapide	Applications industrielles	Pression P.N. 6.5 bar	Confort d'utilisation	Cadence de frappe 3 000 c/min	Excellent rendement
---	--	-------------------------------	---------------------------------	-----------------------	---	---------------------

		A	B	Poids kg	Course piston mm	Pression d'entrée	Niveau sonore dB	Cadence de frappe C/min	Consom- mation l/min	Cadence de frappe C/min	REFERENCE
Pistolet décapeur 19 aiguilles											
		Pistolet pour décapier des surfaces (peintures, rouille, laitier sur soudures, dépôt de ciment) ou altérer la surface des matériaux. Livré équipé d'un jeu de 19 aiguilles Ø 3 mm									
		330	170	2.5	43.5	6.5	94		280	3000	OBD 25025

OUTILS PNEUMATIQUES

PONCEUSES

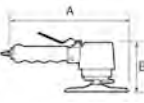
Efficacité	Pression 6 bar	Réglage Régulateur incorporé	Livré avec un embout Profil ISO B	Livré avec un embout Profil 7,2 pour raccordement rapide	Application automobile Préparation avant peinture	Confort d'utilisation
------------	--------------------------	--	---	--	---	-----------------------

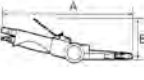
		A	B	Niveau sonore dB	Poids kg	Pression d'entrée	Consom- mation l/min	Vitesse de rotation tr/min	Excentration mm	REFERENCE	
Ponceuse composite orbitale 2 mains											
		Ponceuse traditionnelle pour travaux de préparation des surfaces, mastics et finitions avant peinture. Corps gainé offrant une parfaite ergonomie et un grand confort de travail - Gâchette progressive et régulateur incorporé - Livrée avec un plateau auto-agrippant Ø 150 mm									
		270	155	82	1.6	6	230	10 000	9.5	OPS 35016	
Ponceuse à bande 10 mm											
		Ponceuse s'adaptant aux formes les plus diverses tels que les angles. Régulateur de vitesse incorporé - Echappement sur silencieux - Dispositif de verrouillage pour échange rapide des bandes - Dispositif d'alignement de bande. Livrée avec une bande et clé de service.									
		340	110	79	0.80	6	400	16 000		OPB 25008	

OUTILS PNEUMATIQUES

PONCEUSES

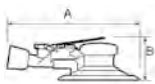
Efficacité	Pression 6 bar	Réglage Régulateur incorporé		Livré avec un embout Profil ISO B	Livré avec un embout Profil 7,2 pour raccordement rapide	Application automobile Préparation avant peinture		Confort d'utilisation		
		A	B	Niveau sonore dB	Poids kg	Pression d'entrée	Consom- mation l/min	Vitesse de rotation tr/min	Excentration mm	REFERENCE
Ponceuse composite orbitale aspirante										
										
		225	100	76	0.95	6	400	10 000	5	OPA 46009
<p>Ponceuse haut de gamme en composite destinée aux travaux de carrosserie demandant un haut niveau de finition. Régulateur intégré - Hauteur réduite pour un meilleur contrôle - Ceinture de préhension ergonomique Echappement sur silencieux, connexion d'aspiration sur raccord tournant - Livrée avec un plateau auto-agrippant Ø 150mm perforé 6 trous</p>										

OUTILS PNEUMATIQUES

POLISSEUSES

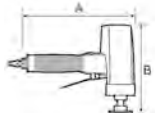
Application automobile Préparation avant peinture	Efficacité	Pression 6.5 bar	Réglage Régulateur incorporé		Confort d'utilisation	Livré avec un embout Profil ISO B	Livré avec un embout Profil 7,2 pour raccordement rapide			
		A	B	Diamètre plateau mm	Niveau sonore dB	Poids kg	Pression d'entrée	Consom- mation l/min	Vitesse de rotation tr/min	REFERENCE
Polisseuse verticale Ø 180 mm										
										
		200	180	150/180	85	2,4	6,5	280	2000	OLV 35024
<p>Polisseuse offrant un grand confort de travail, échappement canalisé, vitesse réglage avec maintien de la puissance et du couple constant - Poignée gainée isolant du froid et des vibrations - Régulateur incorporé - Echappement sur silencieux - Livrée avec un plateau Ø 180 mm</p>										

OUTILS PNEUMATIQUES

PERCEUSES









Efficacité		Pression 6.5 bar		Confort d'utilisation			Livré avec un embout Profil ISO B		Livré avec un embout Profil 7.2 mm	
		A	B	Diamètre mandrin mm	Niveau sonore dB	Poids kg	Pression d'entrée	Consom- mation l/min	Vitesse de rotation tr/min	REFERENCE
Perceuse révolver : Ø 10 mm										
										
		195	145	10	87	1.1	6	180	2200	OGT 25011
Perceuse révolver composite réversible : 10 mm										
										
		185	165	10	93	1	6	180	1800	OGT 36010
Perceuse à renvoi d'angle réversible 10 mm										
										
		205	120	10	85	1,10	6,5	140	1 000	OGG 35011
Perceuse révolver composite réversible: 13 mm										
										
		205	165	13	93	1.3	6	100	800	OGL 26013

OUTILS PNEUMATIQUES

VISSEUSES

Confort de travail Vibrations inférieures à 2,5 m/s ²		Pression 6.5 bar		Livré avec un embout Profil ISO B			Livré avec un embout Profil 7.2			Mandrin Automatique	
		A	B	Vitesse de rotation tr/min	Consommation l/min	Diamètre mandrin mm	Niveau sonore dB	Poids kg	Pression d'entrée	Couple de serrage Nm	REFERENCE
Visseuse réversible composite pré-réglée 800 tr/min											
				Visseuse à corps composite offrant un grand confort de travail, isolant du froid et des vibrations. Mandrin automatique 6 pans 1/4" - Embrayage par pression Débrayage automatique au couple maxi de 20 N/m Mise en route et inversion d'une seule main Gâchette progressive permettant des démarrages précis avec un contrôle parfait de la vitesse de rotation. Echappement inférieur canalizable sur silencieux.							
		215	165	800	120	6 pans 1/4"	78	1.3	6.5	5/16	OVT 36013
Visseuse composite réversible pré-réglée : 1 800 tr/min											
				Visseuse à corps composite offrant un grand confort de travail, isolant du froid et des vibrations Mandrin automatique 6 pans 1/4" - Embrayage par pression Débrayage automatique au couple maxi 15 N/m Mise en route et inversion d'une seule main Gâchette progressive permettant des démarrages précis avec un contrôle parfait de la vitesse de rotation Echappement inférieur canalizable sur silencieux							
		195	165	1800	120	6 pans 1/4"	85	1.2	6.5	5/13	OVT 26012
Visseuse droite réversible ajustable 1 800 tr/min											
				Mandrin automatique 6 pans 1/4" Embrayage par pression Débrayage automatique au couple maxi Couple ajustable par réglage de la pression du ressort. Gâchette progressive permettant des démarrages précis avec un contrôle parfait de la vitesse de rotation Echappement arrière							
		254	65	1 800	280	6 pans 1/4"	83	1,10	6,5	1/11	OVD 25011

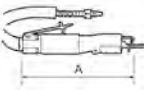

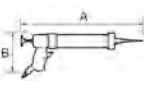



OUTILS PNEUMATIQUES SPECIFIQUES

Livré avec un embout Profil ISO B		Livré avec un embout Profil 7.2		Efficacité			Pression P.N. 6,5 et 6 bar		
		A	B	Diamètre tête porte embouts mm	Niveau sonore dB	Pression d'entrée	Consom- mation	Course lame mm	REFERENCE
Riveteuse hypopneumatique en coffret									
				Riveteuse pour pose de rivets POP - Diamètre maximum rivets alu 4,8 mm Récupérateur de tiges - Embouts pour rivets : 2,4 - 3,2 - 4 - 4,8 mm Livré avec accessoires de rechange et kit d'entretien					
		160	275	23	50	6,5	1,4 l/coup		ORH 25015
Riveteuse hypopneumatique 6,2 mm en coffret									
				Outil doté d'une puissance exceptionnelle 1800 kg de poussée, facilitant et répondant aux besoins de rivetage aveugle dans l'atelier. Récupérateur arrière des clous de rivet Livré avec clé de service et jeu de mors					
		225	330	28	50	6,5	3,5 l/coup		ORH 45023
Crayon graveur									
				Crayon à graver à pointe carbure permettant le marquage ou repérage sur tout support. Mise en route par rotation. Echappement par silencieux. Pointe carbure interchangeable					
		162	17		94	6,5	30 l/min		OCG 35001
Scie droite									
				Outil universel de découpe pour travaux de carrosserie et de serrurerie Régulateur incorporé permettant d'ajuster la vitesse en fonction des matériaux. Echappement sur silencieux Gâchette de sécurité pour éviter les démarrages accidentels. Livré avec un assortiment de lames Cadence de coupe : 10 000 coups/min Capacité de coupe : 1,6 mm					
		280			70	6	100 l/min	9	OSD 25007
Pistolet à extruder universel									
				Pistolet universel et simple d'utilisation, doté d'un piston. il permet d'extruder les sachets et les cartouches standards. Doté d'un dispositif de décompression sur la position arrêt.					
		460	160			6			OXF 35013

ACCESSOIRES POUR OUTILS PNEUMATIQUES

		DESIGNATION	REFERENCE
Gaine d'échappement			
		Pour meuleuses, perceuses et visseuses	OMD GE
		Pour meuleuse OMG 35004	OMD GE2
Accessoires pour marteau burineur			
		Retenue d'outil à billes, idéale dans les utilisations de matériaux tendres	OBM ROB
		Ressort de retenue ouvert	OBM RRO
		Burin classique long. 180 mm - Largeur 20 mm	OBM BL180
		Poinçon	OBM POI
		Burin coupe rivet et point de soudure	OBM BCR
		Burin découpeur de panneau	OBM BDP
		Burin découpeur d'échappement	OBM BDE
Accessoire pour pistolet décapeur			
		1 jeu de 19 aiguilles	OBD AIG
Accessoire pour meuleuse composite droite			
		Support disque à tronçonner Ø 7,5 mm sur tige de Ø 6 mm	OMD SDT
Accessoires pour disqueuse revolver			
		Plateau nylon ventilé pour disques 127 mm	ODR PN127
		Adaptateur mâle G 1/4, possibilité d'utilisation de différents supports souples Ø 75 mm	ODR AD14
		1 jeu de 3 plateaux fibre pour disque abrasif	ODR PF3
Accessoires pour disqueuse à renvoi d'angle			
		Plateau nylon avec écrou 180 mm	ODR PN180
		Plateau semi-rigide 180 mm	ODR PSM180

ACCESSOIRES POUR OUTILS PNEUMATIQUES

		DESIGNATION	REFERENCE
Accessoire pour ponceuse orbitale aspirante			
		1 plateau auto-agrippant Ø 150 mm perforé 6 trous	OPA P1506
Accessoire pour ponceuse orbitale 2 mains			
		Plateau auto-agrippant Ø 150 mm	OPS P150
Accessoire pour polisseuse verticale			
		Plateau auto-agrippant semi-souple	
		Ø 150 mm	OLV P150
		Ø 180 mm	OLV P180
Accessoires pour perceuse révoluer			
		Mandrin automatique 10 mm	OGT MA10
		Mandrin automatique 13 mm	OGL MA13
Accessoire pour visseuse composite			
		Embout magnétique de vissage permettant le maintien de la vis	OVT EMV
Accessoires pour scie droite			
		Jeu de 5 lames 10 dents/cm (pour tôle et aluminium)	OSD LAMD10
		Jeu de 5 lames 13 dents/cm (acier)	OSD LAMD13
		Jeu de 5 lames 6 dents/cm (plastique bois composite)	OSD LAMD6

HUILE POUR OUTILS PNEUMATIQUES

		DESIGNATION	REFERENCE
Huile pneumatique			
		Huile minérale Norme ISO : VG 22 Viscosité à 40° C : 20 cSt (centistokes) Viscosité à 100° C : 4.1 cSt Densité : 0.86 Index de viscosité : 104 Point d'éclair VO supérieur à 200° C Point d'écoulement inférieur à - 9° C Lubrifiant recommandé pour contact avec caoutchouc, élastomère et autres matériaux polymères.	
		Huile minérale ISO VG 22 pour circuits d'air comprimé, lubrificateurs, outillages pneumatiques. Bidon de 2 litres	VAS 2442

postes de travail

ÉQUILIBREURS, BOÎTIER D'ÉNERGIES ET BRAS DE SUSPENSION

AMÉNAGEMENT RATIONNEL DES POSTES DE TRAVAIL



ÉQUILIBREURS À CÂBLE

- Éliminent les efforts physiques
- Augmentent la productivité
- Rationalisent les postes de travail
- Applications: postes de montage, assemblage, conditionnement
- Réglage simple pour positionner l'outil selon son poids et sa hauteur par rapport au plan de travail
- Sécurité de fixation
- Construction robuste en aluminium
- Longévité du câble en acier inox
- Nombreux systèmes de sécurité intégrés

ÉQUILIBREURS AVEC ALIMENTATION DIRECTE

- Flexible polyuréthane souple permettant une alimentation et une fixation de l'outil à la hauteur désirée
- Sécurité de fixation

BOÎTIER D'ÉNERGIE

Le boîtier d'énergies fournit des branchements électriques et pneumatiques au poste de travail. Simple et sûr, le boîtier d'énergies est un moyen d'alimenter à la fois :

- Outils pneumatiques
- Soufflettes
- Outils électro-portatifs
- Baladeuses

► Utilisation :

Suspendu à un point fixe, à la hauteur souhaitée, le boîtier d'énergies facilite le travail de l'opérateur, il permet d'éviter :

- Les déplacements dans l'atelier
- Les tuyaux qui traînent au sol
- Les manipulations fastidieuses dans l'espace de travail

► Avantages :

Grâce à sa poignée d'accroche et de suspension, le boîtier est facilement saisi tout en libérant le poste de travail.

BRAS DE SUSPENSION ET DE DISTRIBUTION

Les bras de suspension assurent :

- Le maintien de l'outil "à portée de main" en libérant la surface du plan de travail
- L'alimentation pneumatique de l'outil sans tuyau encombrant et apparent

► Utilisation :

- Poste fixe de travail (visseuse, agrafeuse, ponceuse...)
- Poste fixe d'entretien sur machine outil (soufflette, soufflette aspirante...)
- Suspension d'outils pneumatiques ou électriques (avec équilibrage par ajout d'équilibreurs, tuyaux spiralés avec ou sans alimentation)







► Avantages :

- Disponibilité immédiate de l'outil
- Poids de l'outil supporté par le bras
- Rationalisation des postes de travail
- Gain de productivité

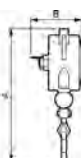

► Caractéristiques des bras :

- Souplesse de la rotation du bras de suspension
- Encombrement minimum
- Peu de surface d'établi occupée par le pied
- Solidité et légèreté de l'ensemble
- Ensemble monté étanche, prêt à positionner
- Bras équipés en standard d'un embout en partie basse pour l'arrivée d'air et d'un raccord rapide de sécurité pour l'alimentation de l'outil.

EQUILIBREURS A CABLE SERIE BAL

Effort physique diminué	Economique	Solution simple	Longévité	Application automobile	Applications industrielles	Matière Câble acier inox	Matière Aluminium	
		A	B	Longueur câble m	Charge mini kg	Charge maxi kg	Poids de l'équilibreur kg	REFERENCE
Série A : capacité de 0.4 kg à 3 kg								
								<ul style="list-style-type: none"> - Equilibrage de la charge par réglage de la tension du ressort (molette crantée) - Fixation de la charge par mousqueton tournant
		282	55	1,6	0.4	1	0.57	BAL 0410A
		282	55	1,6	1	2	0.6	BAL 1020A
		282	55	1,6	2	3	0.74	BAL 2030A
Série B: capacité de 2 kg à 8 kg								
								<ul style="list-style-type: none"> - Equilibrage de la charge par réglage de la tension du ressort - Sécurité de déroulement de câble par un guide anti-friction - Système de blocage de charge en cas de rupture du ressort
		353	88	2	2	4	1.9	BAL 2040B
		353	88	2	4	6	1.98	BAL 4060B
		353	88	2	6	8	2.28	BAL 6080B
Série CP: capacité de 8 kg à 14 kg								
								<ul style="list-style-type: none"> - Equilibrage de la charge par réglage de la tension du ressort - Sécurité de déroulement de câble par un guide anti-friction - Système de blocage de charge en cas de rupture du ressort
		381	98	2.50	8	10	3.43	BAL 80100CP
		381	98	2.50	10	14	3.58	BAL 100120CP
Série DP : capacité de 4 kg à 25 kg								
								<ul style="list-style-type: none"> - Equilibrage de la charge par réglage de la tension du ressort - Dispositif de freinage permettant le positionnement de la charge à différentes hauteurs - Système de blocage de charge en cas de rupture du ressort - Suspension de l'équilibreur par mousqueton de sécurité tournant - Câble de sécurité pour fixation secondaire de l'équilibreur au plafond - Câble inox avec guide en matériau anti-friction - Enroulement et déroulement du câble sur tambour conique monté sur roulement à bille
		551	140	2	4	7	4.94	BAL 4070DP
		551	140	2	7	10	5.3	BAL 70100DP
		551	140	2	10	14	5.67	BAL 100140DP
		551	140	2	14	18	6.26	BAL 140180DP
		551	140	2	18	22	5.89	BAL 180220DP
		551	140	2	22	25	6.53	BAL 220250DP



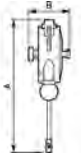

EQUILIBREURS A CABLE SERIE BAL

Effort physique diminué	Economique	Solution simple	Longévité	Application automobile	Applications industrielles	Matière Câble acier inox	Matière Aluminium			
			A	B	Longueur câble m	Charge mini kg	Charge maxi kg	Poids de l'équilibreur kg	REFERENCE	
Série F : capacité de 25 kg à 105 kg										
				<ul style="list-style-type: none"> - Equilibrage de la charge par réglage de la tension du ressort - Système de blocage de charge en cas de rupture du ressort - Suspension de l'équilibreur par mousqueton de sécurité tournant - Câble de sécurité pour fixation secondaire de l'équilibreur au plafond - Câble inox avec guide en matériau anti-friction - Enroulement et déroulement du câble sur tambour conique monté sur roulement à bille 						
		636	220	2	25	30	11.3	BAL 250300F		
		636	220	2	30	35	11.3	BAL 300350F		
		636	220	2	35	45	12.21	BAL 350450F		
		636	220	2	45	55	12.21	BAL 450550F		
		636	220	2	55	65	13.06	BAL 550650F		
		636	220	2	65	75	13.86	BAL 650750F		
		636	220	2	75	90	16.84	BAL 750900F		
636	220	2	90	105	17.77	BAL 9001050F				
Série E : alimentation directe pour flexible - capacité de 0.4 kg à 2.5 kg										
				<ul style="list-style-type: none"> - Alimentation directe de l'outil par tuyau en polyuréthane - Tension du ressort par molette crantée - Raccord mâle G 1/4 Gaz BSP préteflonné - Pression de service : 8 bar à 20°C 						
		298	104	1.4	0.4	0.8	1.12	BAL 0408E		
		298	104	1.4	0.75	1.5	1.13	BAL 0715E		
298	104	1.4	1.2	2.5	1.26	BAL 1225E				

EQUILIBREURS SPIRALEX AVEC TUYAU SPIRALÉ

Effort physique diminué	Economique	Solution simple	Longévité	Fluide Air	Application automobile	Applications industrielles		
			Poids de l'outil kg	Sortie Gaz BSP	Tube spiralé mm	Longueur Maxi en m	Longueur Mini en m	REFERENCE
Equilibriseurs avec tuyau spiralé								
		0.2 à 0.5	G 1/4 Mâle	4.5 x 6	0.65	0.28 à 0.45	SPI 1	
		0.7 à 2	G 1/4 femelle	6.3 x 8	1.06	0.46 à 0.90	SPI 3	
		2.5 à 5	G 3/8 Femelle	9.5 x 12	1.45	0.92 à 1.42	SPI 5	
		6 à 10	G 3/8 Femelle	9.5 x 12	1.44	0.70 à 0.98	SPI 7	

BRAS DE SUSPENSION ET DE DISTRIBUTION

Pression 10 bar	Matière Aluminium	Charge maxi 3 kg	Hauteur crochet de suspension 1130 mm	Orientable 180°			
		A	B	C	D	DESIGNATION	REFERENCE
Bras de suspension articulé							
						Les bras de suspension assurent : - le maintien de l'outil "à portée de main" en libérant la surface du plan de travail, - l'alimentation pneumatique de l'outil sans tuyau encombrant et apparent Alimentation d'entrée : G 1/4 BSP femelle Sortie : G 1/4 BSP femelle équipé d'un raccord de sécurité.	
		860	750	1210	45x45	Crochet de suspension coulissant sur bras secondaire Entrée : équipé d'un embout ISO B Sortie : équipé d'un raccord ISO B - ISI	BSIS 750
		860	750	1210	45x45	Crochet de suspension coulissant sur bras secondaire Entrée : équipé d'un embout ISO C Sortie : équipé d'un raccord ISO C	BSC 750
Bras de suspension double articulation							
						Les bras de suspension assurent : - le maintien de l'outil "à portée de main" en libérant la surface du plan de travail, - l'alimentation pneumatique de l'outil sans tuyau encombrant et apparent Alimentation d'entrée : G 1/4 BSP femelle Sortie G 1/4 BSP femelle	
		1075	450	1210	45x45	Crochet de suspension coulissant sur bras secondaire Entrée : G 1/4 femelle équipée d'un embout ISO B Sortie : G 1/4 femelle, équipée d'un raccord ISO B - ISI	BSIS 1000
		1075	450	1210	45x45	Crochet de suspension coulissant sur bras secondaire Entrée: G 1/4 femelle, équipé d'un embout ISO C Sortie : G 1/4 femelle, équipé d'un raccord ISO C	BSC 1000

BOITIER MULTIENERGIES AIR COMPRIME / ELECTRICITE

Utilisation par suspension à un point fixe	Ergonomie du poste de travail	Facilité d'emploi et sécurité	Tube spiralé d'alimentation d'air : 8 x 12 mm	Alimen- tation Air/Electricité	Poids du boîtier : 2 kg	Pression de service : 8 bar
				DESIGNATION	REFERENCE	
Boîtier de distribution Electricité/Air comprimé						
	Le boîtier d'énergie combine alimentation pneumatique et électrique (baladeuses, outils électro-portatifs, soufflettes, outils pneumatiques). Le boîtier évite les déplacements dans l'atelier, les tuyaux qui traînent au sol, les manipulations fastidieuses dans l'espace de travail. Longueur de la chaîne : 3 mètres Hauteur conseillée de suspension du boîtier : 2 mètres					
	Boîtier équipé de : - 3 prises 230 V 16 A pour système français - 2 raccords ISI 061102 Puissance maxi : 3 500 W Longueur de la chaîne : 3 m					BEIS 230F

lubrification

POMPES PNEUMATIQUES ET RÉCUPÉRATEURS

EFFICACITÉ AUX POSTES D'ENTRETIEN



POMPES À GRAISSE

- ▶ Les pompes à graisse PREVOST sont utilisées pour la distribution de la graisse à haute pression.
- ▶ Le ratio de compression est de 58 pour 1 (soit 58 fois supérieur à la pression d'entrée de l'air comprimé).
- ▶ Ces pompes sont équipées d'un filtre à tamis protégeant le corps de pompe situé à l'extrémité des cannes d'aspiration.

POMPES À HUILE

- ▶ Les pompes à huile PREVOST sont utilisées pour la distribution de fluides à faible viscosité, tels que les huiles moteurs ou le gazoil et à moyenne pression.
- ▶ Le ratio de compression est de 4 pour 1 (soit 4 fois supérieur à la pression d'entrée de l'air comprimé).
- ▶ Toutes les pompes pneumatiques sont à double effet, simples, compactes et robustes.
- ▶ L'ensemble des composants sont spécialement traités et assemblés avec précision.

RÉCUPÉRATEURS D'HUILE

- ▶ Les récupérateurs d'huile sont utilisés pour effectuer les vidanges d'huile moteur ou de boîte, par gravité ou par aspiration, sur tous types de véhicules.
- ▶ Les unités mobiles par aspiration évitent l'immobilisation des ponts élévateurs. Les récupérateurs permettent d'optimiser le flux des véhicules et de mieux gérer l'espace dans les ateliers.
- ▶ Les récupérateurs d'huile par aspiration avec bol volumétrique ont une autonomie qui permet de vidanger plusieurs moteurs à la suite. Grâce à une vanne 3 voies, une seule dépressurisation est suffisante pour réaliser 5 à 10 vidanges.

Cette innovation permet de :

- créer le vide dans la cuve et le bol
- isoler le vide du bol pour aspirer l'huile usagée
- vider l'huile usagée, du bol dans la cuve
- recréer le vide dans le bol, grâce au vide de la cuve, pour réaliser d'autres vidanges par aspiration







POMPES À GRAISSE PNEUMATIQUES



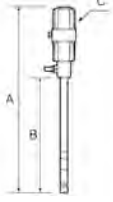

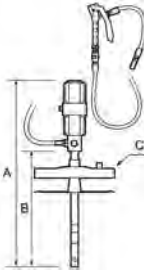

Rapport de compression 58:1	Débit d'huile : 900 gr/min	Pression d'entrée : 4 à 8 bar	Sortie de graisse: G 1/4 mâle	Ergonomie gain de temps	Sécurité de l'installation	Pression Max. 470 bar	Entrée Air : G 1/4 femelle	Consommation d'air : 130-160 l/min
			A	B	C	DESIGNATION	REFERENCE	
Pompe à graisse pour fût de 12/20kg								
		680	410	80	Longueur de tube : 410 mm		EPG PR20	
Kit complet portable pour fût de graisse 12/20 kg								
		680	410	280	- pompe pour fût 12/20 kg long. tube : 410 mm - couvercle + membrane - pistolet de distribution - raccord d'étanchéité - 4 m tuyau caoutchouc - poignée de transport		EPG KR20	
					Kit complet portable EPG KR20 pour fût de graisse 12/20 kg avec FRL		EPG KRF20	
					Kit complet portable EPG KR20 pour fût de graisse 12/20 kg avec FRL et chariot		EPG KRFC20	
Pompe à graisse pour fût de 20 à 30 kg								
		740	470	80	Longueur de tube: 470 mm		EPG PR30	
Kit complet portable pour fût de graisse 20 à 30 kg								
		740	470	320	- pompe pour fût 20/30 kg long. tube 470 mm - couvercle + membrane - pistolet de distribution - raccord d'étanchéité - 6m tuyau caoutchouc		EPG KR30	
					Kit complet portable EPG KR30 pour fût de graisse 20 à 30 kg avec FRL		EPG KRF30	
					Kit complet portable EPG KR30 pour fût de graisse 20/30 kg avec FRL et chariot		EPG KRFC30	

POMPES À GRAISSE PNEUMATIQUES

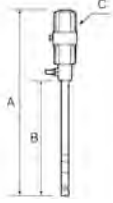

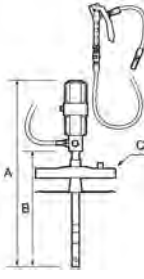
Rapport de compression 58:1	Débit d'huile : 900 gr/min	Pression d'entrée : 4 à 8 bar	Sortie de graisse: G 1/4 mâle	Ergonomie gain de temps	Sécurité de l'installation	Pression Max. 470 bar	Entrée Air : G 1/4 femelle	Consommation d'air : 130-160 l/min
--------------------------------	-------------------------------	----------------------------------	----------------------------------	----------------------------	-------------------------------	--------------------------	----------------------------------	--

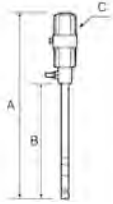
		A	B	C	DESIGNATION	REFERENCE
Pompe à graisse pour fût de 50 à 60 kg						
		1000	730	80	Longueur de tube : 730 mm	EPG PR60
Kit complet portable pour fût de graisse 50 à 60 kg						
		1000	730	340 - 380	- pompe pour fût 50/60 kg long. tube 730 mm - couvercle + membrane - pistolet de distribution - raccord d'étanchéité - 6 m tuyau caoutchouc	EPG KR60
					Kit complet EPG KR60 pour fût de graisse 50 à 60 kg avec FRL	EPG KRF60
					Kit complet EPG KR60 pour fût de graisse 50/60 kg avec FRL et chariot de transport	EPG KRFC60
Accessoires et pièces détachées pour pompes à graisse						
					Couvercle Ø 280 mm pour ensemble EPG KR20	EPG CV20
					Couvercle Ø 320 mm pour ensemble EPG KR30	EPG CV30
					Couvercle métallique Ø 340 à 380 mm pour ensemble EPG KR60	EPG CV60
					Couvercle métallique Ø 380 à 410 mm	EPG CV65
					Membrane d'étanchéité pour fûts Ø 270 mm pour ensemble EPG KR20	EPG MB20
					Membrane d'étanchéité Ø 310 mm pour ensemble EPG KR30	EPG MB30
					Membrane d'étanchéité pour fûts Ø 280 à 300 mm pour ensembles EPG KR20 et EPG KR30	EPG MB31
					Membrane pour fûts Ø 300 à 330 mm pour ensembles EPG KR30 et EPG KR60	EPG MB34
					Membrane d'étanchéité Ø 370 mm pour ensemble EPG KR60	EPG MB60
					Membrane d'étanchéité Ø 380 à 410mm pour ensemble EPG KR60	EPG MB65
					Tuyau caoutchouc 4 m pour ensemble EPG KR20	EPG TC414
					Tuyau caoutchouc 6 m pour ensembles EPG KR30 et EPG KR60	EPG TC614
					Tuyau G 1/4 G 2 m - raccordement pompe à enrouleur graisse	EPG TC214
					Raccord d'étanchéité pour ensembles EPG KR20, EPG KR30 et EPG KR 60	EPG RT14
					Raccord cardan étanchéité	EPG SW14
					Poignée de transport pour ensemble EPG KR20	EPG PG
					Vis de Ø 30 mm pour maintien de la pompe à l'intérieur du fût	EPG VS30
				Pistolet de distribution avec tube souple	EPG PT400	
				Pistolet avec tube rigide de 15 cm	EPG PT150R	
				Chariot de transport de fût de 12/20 kg	EPG CA20	
				Chariot de transport de fût de 20 à 60 kg	EPG CA60	

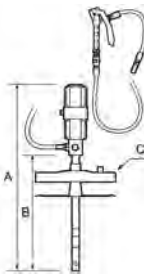
POMPES À HUILE PNEUMATIQUES

Rapport de compression 4:1	Débit d'huile : 20 l/min	Pression d'entrée: 6 à 8 bar	Sortie d'huile : G 1/2 mâle	Ergonomie Gain de temps	Sécurité de l'installation	Pression Max. 470 bar	Entrée d'air : G 1/4 femelle d'huile : G 1 femelle	Consommation d'air : 200-250 l/min
Pompe à huile pour fût de 50 à 60 litres			A	B	C	DESIGNATION	REFERENCE	
		1000	730	80	Longueur de tube : 730 mm		EPH PR60	
Kit complet pour fût d'huile de 50 à 60 litres						Ensemble complet composé de : - 1 pompe pour fût de 50/60 litres longueur tube : 730 mm - 1 pistolet de distribution d'huile - 1 tuyau caoutchouc 5 m, pression 100 bar	EPH KR60	
		1000	730		Kit complet EPH KR60 pour fût d'huile 50/60 litres avec FRL		EPH KRF60	
					Kit complet EPH KR60 pour fût d'huile 50/60 litres avec FRL et chariot de transport		EPH KRFC60	
Pompe à huile pour fût de 180 à 220 litres								
		1210	940	80	Longueur de tube 940 mm		EPH PR220	
Kit complet pour fût d'huile de 180 à 220 litres						Ensemble complet composé de : - 1 pompe pour fût de 180/220 litres longueur tube : 940 mm - 1 pistolet de distribution d'huile - 1 tuyau caoutchouc 5 m, pression 100 bar	EPH KR220	
		1210	940	80	Kit complet EPH KR220 pour fût d'huile 180/220 litres avec FRL		EPH KRF220	
					Kit complet EPH KR220 pour fût d'huile de 180/220 litres avec FRL et chariot de transport		EPH KRFC220	

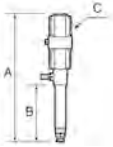
POMPES À HUILE PNEUMATIQUES

Rapport de compression 4:1	Débit d'huile : 20 l/min	Pression d'entrée: 6 à 8 bar	Sortie d'huile : G 1/2 mâle	Ergonomie Gain de temps	Sécurité de l'installation	Pression Max. 470 bar	Entrée d'air : G 1/4 femelle d'huile : G 1 femelle	Consommation d'air : 200-250 l/min
			A	B	C	DESIGNATION		REFERENCE
Pompe à huile pour fût de 180 à 220 litres								
		445	175	80	Pompe à huile seule		EPH MR220	
Kit complet MURAL pour fût d'huile de 180 à 220 litres								
		445	940	80	- 1 pompe murale pour fût de 180/220 litres Long. tube 940 mm - 1 équerre murale avec écrou G 2 - 1 tuyau Ø G 1, longueur 2 m		EPH MRK220	
					Kit complet mural EPH MRK220 pour fût de 180/220 litres avec FRL		EPH MRKF220	
Pistolet volucompteur de distribution d'huile								
					Débit: de 1 à 30 l/min Précision : +/- 0,5 % Perte de charge : 0,7 bar Pression max. d'exercice : max. 70 bars Pression d'éclatement : 140 bars Comptage précis, faible perte de charge.			
					Mesure électronique du volume d'huile distribué Lecture des mesures sur écran LCD Entrée taraudée G 1/2		EPH VOL12	
Accessoires pour pompes à huile								
					Tuyau caoutchouc 5 m pression 100 bar pour ensembles EPH KR60 et EPH KR220		EPH TC512	
					Tuyau Ø G 1 - Longueur 2 m pour ensemble EPH MRK 220		EPH TC201	
					Tuyau caoutchouc G 1/2 - 2 m pression 100 bar pour liaison pompe enrouleur		EPH TC212	
					Tube longueur 940 mm avec vis pour ensemble EPH MRK220		EPH TB940	
					Egouttoir huile avec crochet de fixation pour pistolet		EPH EGR10	
					Equerre murale avec écrou G 2 pour ensemble EPH MRK220		EPH SP	
					Pistolet de distribution d'huile		EPH PT12	
					Chariot de transport pour fût de 180/220 litres		EPH CA220	
					Chariot de transport pour fût de 20/60 litres		EPH CA60	

RECUPERATEURS D'HUILE

Efficacité Longévité		Matériau Acier traité et peinture époxy			Ergonomie Rationalisation de l'espace de travail		Sécurité d'utilisation		
		A	B	C	DESIGNATION	REFERENCE			
Récupérateur d'huile par gravité, version économique									
					<ul style="list-style-type: none"> - Capacité de la cuve : 90 litres - Grille de filtration intégrée dans le bac de récupération - Bac de récupération: 12 litres Ø 360 mm réglable en hauteur et orientable à 360° - Grille de filtration intégrée dans le bac de récupération - Indicateur de niveau de remplissage dans la cuve - Soupape de gonflage par valve, tarée à 0.5 bar contrôlé par un manomètre - Vanne d'évacuation pour huile usagée - Tuyau d'évacuation d'huile usagée de 2 mètres - Roues avant fixes et arrières pivotantes pour une meilleure manipulation 				
		1800	560	550	Récupérateur d'huile de 90 l - par gravité	ERH G90			
Récupérateur d'huile par aspiration avec bol volumétrique									
					<ul style="list-style-type: none"> - Capacité de la cuve: 65 litres - Capacité du bol volumétrique: 8 litres - Kit de 5 buses d'aspiration Ø de 5 mm à 10 mm par 800 mm - Embouts de vidange directement adaptable dans les puits de jauge - Tuyau de 2 mètres, d'aspiration pour montage de buse dans le puits de jauge - Indicateur de niveau de remplissage dans la cuve - Soupape de gonflage tarée par valve à 0.5 bar contrôlé par un manomètre - Système de venturi créant le vide contrôlé par un manomètre - Tuyau d'évacuation d'huile usagée de 2 mètres - Vanne d'évacuation pour huile usagée - Roues avant fixes et arrières pivotantes pour une meilleure manipulation 				
		1230	500	490	Récupérateur d'huile par aspiration - 65 litres	ERH AB65			
Récupérateur 65 litres par aspiration et gravité avec bol de décharge									
					<ul style="list-style-type: none"> - Capacité de la cuve : 65 litres - Capacité du bol volumétrique : 8 litres - Kit de 5 buses d'aspiration Ø de 5 mm à 10 mm par 800 mm - Embouts de vidange directement adaptable dans les puits de jauge - Tuyau de 2 mètres, d'aspiration pour montage de buse dans le puit de jauge - Indicateur de niveau de remplissage dans la cuve - Soupape de gonflage tarée par valve à 0.5 bar contrôlé par un manomètre - Système de venturi créant le vide contrôlé par un manomètre - Tuyau d'évacuation pour huile usagée - Roues avant fixes et arrières pivotantes pour une meilleure manipulation - Grille de filtration intégrée dans le bac de récupération - Bac de récupération : 12 litres Ø 360 mm réglable en hauteur et orientable à 360° 				
		1550	500	490	Récupérateur d'huile par aspiration et gravité - 65 litres	ERH ABG65			

UNITÉS DE TRAITEMENT D'AIR

LE TRAITEMENT DE L'AIR COMPRIMÉ... UNE NÉCESSITÉ POUR :

- Préserver les outils et équipements pneumatiques
- Obtenir un travail de qualité
- Baisser les coûts de maintenance



QUALITÉ

La gamme ALTO garantit l'efficacité de vos outils et équipements pneumatiques

► Filtre ALTO

Les filtres ALTO éliminent les polluants contenus dans l'air comprimé (particules, eau et huile) par filtration et purge.

Ils offrent une séparation à 95% de l'eau, de l'huile et des particules solides supérieures ou égales au seuil de filtration choisi.

► Régulateur ALTO

Les régulateurs ALTO permettent d'ajuster la pression en fonction des utilisations.

► Lubrificateur ALTO

Les lubrificateurs ALTO à brouillard d'huile préservent vos outils pneumatiques en injectant dans l'air préalablement filtré un dosage du lubrifiant précis et fin.

FACILITÉ D'UTILISATION

Le fonctionnement des unités ALTO

- Cuve à système d'emboîtement de type "baïonnette" pour les ensembles G 3/8, G 1/2, G 3/4 et G 1.
- Cuve filetée pour les ensembles en G 1/8, G 1/4.
- Réglage du flux d'huile par ajustement de la vis pointeau.
- Possibilité de remplissage de la cuve d'huile durant l'utilisation.
- Purge manuelle des filtres par pression sur le bouton de drainage.
- Cuve avec protection métallique.

CONSTRUCTION MODULAIRE

La gamme ALTO assure facilité et rapidité d'installation et de maintenance.

Kit de connexion rapide : il permet le montage et démontage de chaque élément sans autre intervention sur le réseau d'air.

Unités complètes prêtes à monter, livrées assemblées, étanches et équipées d'équerres de fixation.

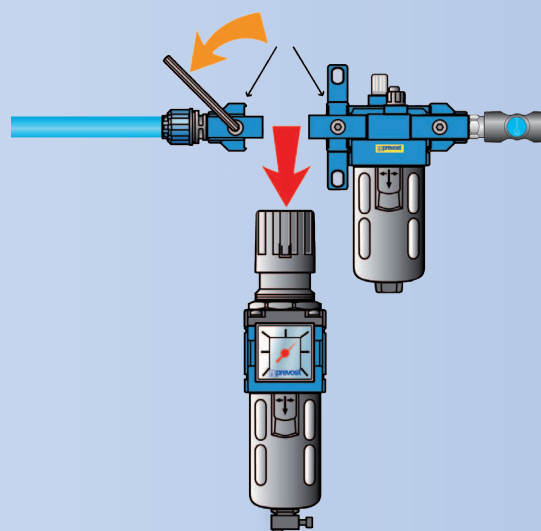

UNITÉ DE TRAITEMENT D'AIR

ALTO 1 - G 1/8 et 1/4



PERFORMANCES ET CARACTÉRISTIQUES TECHNIQUES

FILTRE

Cartouche filtrante : Bronze fritté
Filtration : 25 microns
Purge : manuelle par pression sur le bouton de drainage
Capacité de la cuve : 9 ml
Poids : 0,20 kg

REGULATEUR

Régulateur à membrane, de type progressif
Pression compensée par valve de régulation
Raccordement manomètre : G 1/8
Poids : 0,15 kg

LUBRIFICATEUR

Lubrification par brouillard d'huile
Réglage du débit d'huile par vis pointeau
Capacité de la cuve : 20 ml
Poids : 0,185 kg
Huile recommandée : ISO VG 22 - Ref. VAS 2442 (p. 339)

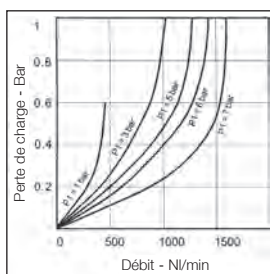

Filtre

Pression d'entrée : 6 bar
 ΔP : 0,3 bar

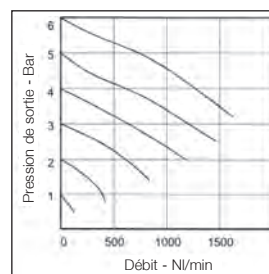

Filtre Régulateur

Pression d'entrée : 7 bar
Pression de service : 6 bar
Perte de charge ΔP : 0,3 bar

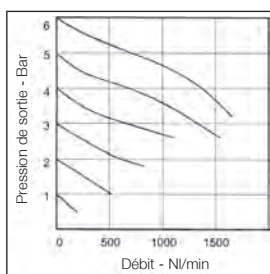

Régulateur

Pression d'entrée : 7 bar
Pression de service : 6 bar
Perte de charge ΔP : 0,3 bar

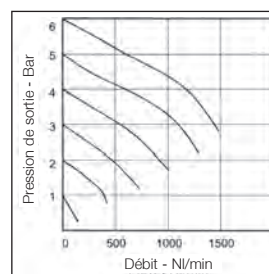

Filtre Régulateur Lubrificateur 2 blocs

Pression d'entrée : 7 bar
Pression de service : 6 bar
Perte de charge ΔP : 0,3 bar

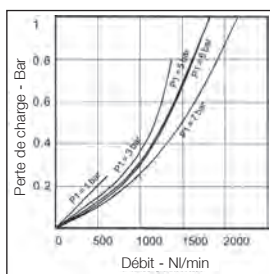

Lubrificateur

Pression d'entrée : 6 bar
 ΔP : 0,5 bar

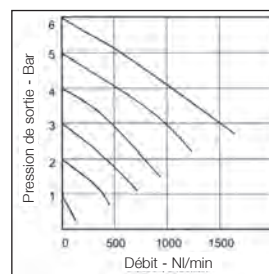







Filtre Régulateur Lubrificateur 3 blocs

Pression d'entrée : 7 bar
Pression de service : 6 bar
Perte de charge ΔP : 0,3 bar

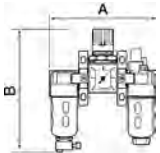
GAMME ALTO 1

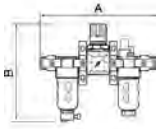

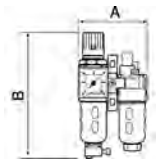

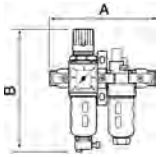

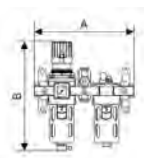

ENSEMBLES DE TRAITEMENT AIR COMPRIME G 1/8 - G 1/4

Purge manuelle	Température 5 - 60 °C	Matière Cuves avec protection métallique	Matière Corps aluminium	Equipé d'un manomètre 0 à 10 bar	Conditionnement en boîtes Ensembles montés
----------------	--------------------------	--	----------------------------	-------------------------------------	--

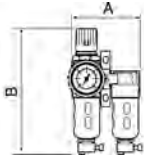
		A	B	Taroudage Gaz BSP	Filtration μ	Débit maxi en l/min	Pression maxi en bar	REFERENCE
Filtre régulateur lubrificateur 3 blocs avec manomètre et fixation								
		146	170	G 1/8	25	500	12	TT SM0
		146	170	G 1/4	25	500	12	TT SM1
Filtre régulateur lubrificateur 3 blocs avec manomètre, fixation et connexions rapides								
		200	170	G 1/4	25	500	12	TT PSM1
Filtre régulateur lubrificateur 2 blocs avec manomètre et fixation								
		92	170	G 1/8	25	500	12	TB SM0
		92	170	G 1/4	25	500	12	TB SM1
Filtre régulateur lubrificateur 2 blocs avec manomètre, fixation et connexions rapides								
		146	170	G 1/4	25	500	12	TB PSM1

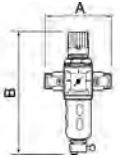

GAMME ALTO 1

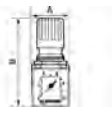
ENSEMBLES DE TRAITEMENT AIR COMPRIME G 1/8 - G 1/4

Purge manuelle	Température 5 - 60 °C	Matière Cuves avec protection métallique		Matière Corps aluminium	Equipé d'un manomètre 0 à 10 bar	Conditionnement en boîtes Ensembles montés		
		A	B	Taraudage Gaz BSP	Filtration μ	Débit maxi en l/min	Pression maxi en bar	REFERENCE
Filtre régulateur lubrificateur 2 blocs avec manomètre, fixation et entretoise pour sortie air sec								
		164	169	G 1/4	25 - 4 sorties non lubrifiées	500	12	TB SME1
Ensemble microfiltre avec régulateur, manomètre et fixation								
		92	170	G 1/4	5 et 0,01 μ	550	12	TB CSM1
Filtre régulateur avec manomètre et fixation								
		40	170	G 1/8	25	550	12	TM SM0
		40	170	G 1/4	25	550	12	TM SM1
Filtre régulateur avec manomètre, fixation et connexions rapides								
		94	170	G 1/4	25	550	12	TM PSM1
Régulateur avec manomètre								
		40	81	G 1/4	-	600	Entrée:15 Sortie:0.5-10	TR M1



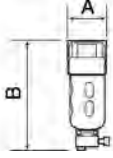

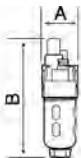
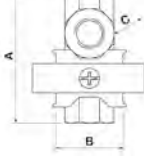





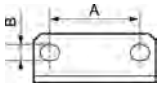

GAMME ALTO 1

MODULES G 1/8 - G 1/4

Purge manuelle	Température 5 °C - 60 °C	Matière Cuves avec protection métallique			Présentation des modules en boîte individuelle	Matière Corps aluminium			
		A	B	C	Taraudage Gaz BSP	Débit maxi en l/min	Pression maxi en bar	Filtration μ	REFERENCE
Filtre et micro filtre									
		40	113		G 1/8	800	12	25	TF 0
		40	113		G 1/4	800	12	25	TF 1
		40	113		G 1/4	800	12	5	TF 105
		40	113		G 1/4	550	12	0,01	TC 1
Régulateur									
		Raccordement manomètre : G 1/8							
		40	81		G 1/8	600	Entrée : 15 Sortie : 0.5-10	-	TR 0
		40	81		G 1/4	600	Entrée:15 Sortie:0.5-10	-	TR 1
		40	81		G 1/4	600	Entrée : 15 Sortie : 0.2-2	-	TR B21
40	81		G 1/4	600	Entrée : 15 Sortie : 0.2-4	-	TR B41		
Lubrificateur									
		40	135		G 1/8	1 350	12	-	TL 0
		40	135		G 1/4	1 350	12	-	TL 1
Filtre-régulateur									
		40	170		G 1/8	550	Entrée : 12 Sortie : 0.5-10	25	TM 0
		40	170		G 1/4	550	Entrée:12 Sortie:0.5-10	25	TM 1
		40	170		G 1/4	550	Entrée:12 Sortie:0.5-10	5	TM 105
Entretoise pour sorties non lubrifiées									
		60	30	48	G 1/4	-	-	4 sorties air sec	TE 1

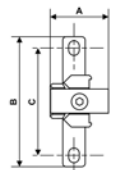
GAMME ALTO 1

ACCESSOIRES

		A	B	C	DESIGNATION	REFERENCE
Equerre de fixation						
		28	5.5		Pour filtre ou lubrificateur G 1/4	TP Q1
		28	5.5		Pour régulateur ou filtre régulateur G 1/4	TR Q1
		-	-		Ecrou pour équerre de régulateur	TR E1
Jeu d'assemblage et de fixation murale						
		50			1 jeu TA S1 pour 2 modules G 1/4 2 jeux TA S1 pour 3 modules G 1/4	TA S1
Jeu d'assemblage						
		12	26		1 jeu TA M1 pour 2 modules G 1/4 2 jeux TA M1 pour 3 modules G 1/4	TA M1
Connexion rapide sur réseau						
		12			G 1/4	TC P1
Jeu de fixation murale et connexion réseau						
		36	73	51	G 1/4	TC S1
Purge automatique à flotteur						
		120			Pour filtre G 1/4	TD F1
Cartouche filtrante pour filtres et micro filtre ALTO 1						
					Cartouche filtrante 25 µ	TF C1
					Cartouche filtrante 5 µ	TF C105
					Cartouche filtrante 0.01 µ	TF C101
Purge manuelle						
					Pour filtres et filtres régulateurs G 1/8 - G 1/4 - G 3/8 - G 1/2 - G 3/4 - G 1	TP F45

UNITÉ DE TRAITEMENT D'AIR

ALTO 2 - G 3/8

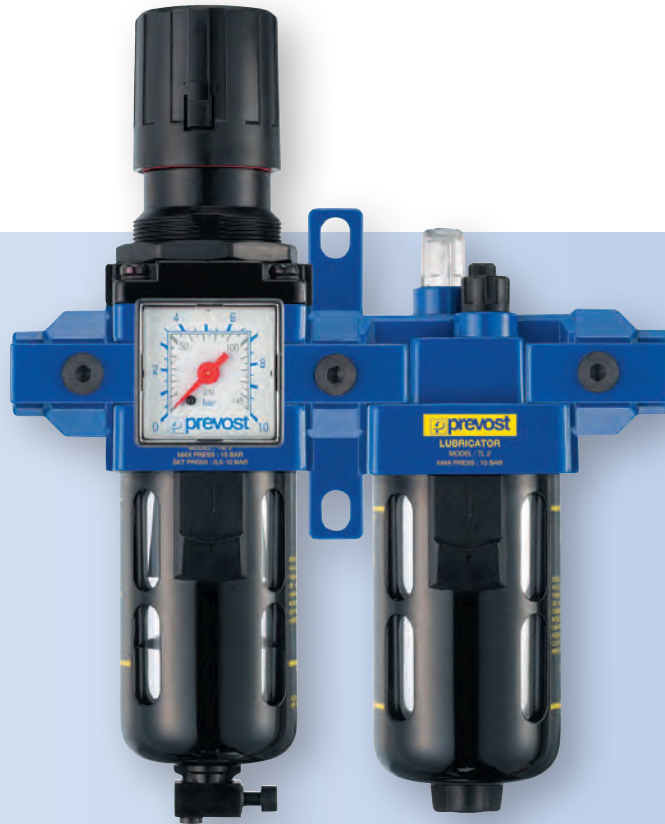

PERFORMANCES ET CARACTÉRISTIQUES TECHNIQUES

FILTRE

Cartouche filtrante : Bronze fritté
Filtration : 25 microns
Purge : manuelle par pression
sur le bouton de drainage
Capacité de la cuve : 32 ml
Poids : 0,45 kg

RÉGULATEUR

Régulateur à membrane,
de type progressif
Pression compensée par
valve de régulation
Raccordement manomètre : G 1/8
Poids : 0,40 kg

LUBRIFICATEUR

Lubrification par brouillard d'huile
Réglage du débit d'huile par vis
pointeau
Capacité de la cuve : 57 ml
Poids : 0,30 kg
Huile recommandée :
ISO VG 22 - Ref. VAS 2442 (p. 339)

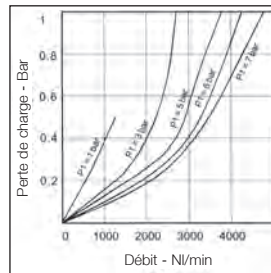

Filtre

Pression
d'entrée : 6 bar
 ΔP : 0,3 bar

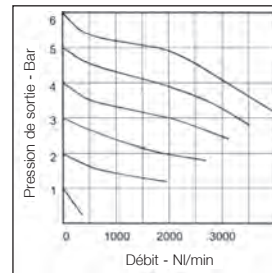

Filtre Régulateur

Pression
d'entrée : 7 bar
Pression de
service : 6 bar
Perte de charge
 ΔP : 0,3 bar

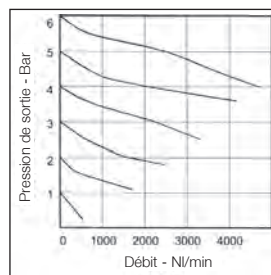

Régulateur

Pression
d'entrée : 7 bar
Pression de
service : 6 bar
Perte de charge
 ΔP : 0,3 bar

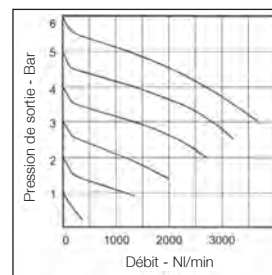

Filtre Régulateur Lubrificateur 2 blocs

Pression
d'entrée : 7 bar
Pression de
service : 6 bar
Perte de charge
 ΔP : 0,3 bar

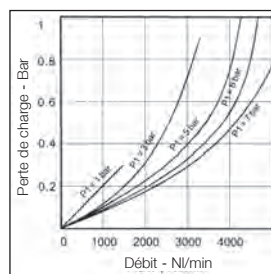

Lubrificateur

Pression
d'entrée : 6 bar
 ΔP : 0,5 bar

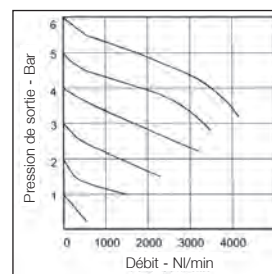





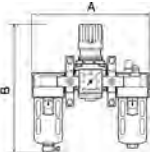

Filtre Régulateur Lubrificateur 3 blocs

Pression
d'entrée : 7 bar
Pression de
service : 6 bar
Perte de charge
 ΔP : 0,3 bar

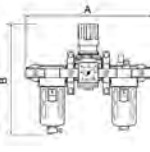

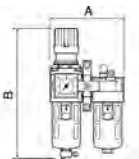

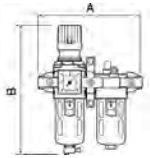
GAMME ALTO 2

ENSEMBLES DE TRAITEMENT D'AIR COMPRIME G 3/8

Purge manuelle		Température 5 °C - 60 °C		Matière Cuves avec protection métallique		Matière Corps aluminium		Equipé d'un manomètre 0 à 10 bar		Conditionnement en boîte Ensembles montés	
		A	B	Taroudage Gaz BSP	Filtration μ	Débit maxi en l/min	Pression maxi en bar	REFERENCE			
Filtre régulateur lubrificateur 3 blocs avec manomètre et fixation											
		192	220	G 3/8	25	2 000	12	TT SM2			
Filtre régulateur lubrificateur 3 blocs avec manomètre, fixation et connexions rapides											
		250	220	G 3/8	25	2 000	12	TT PSM2			
Filtre régulateur lubrificateur 2 blocs avec manomètre et fixation											
		124	220	G 3/8	25	1 250	12	TB SM2			
Filtre régulateur lubrificateur 2 blocs avec manomètre, fixation et connexions rapides											
		182	220	G 3/8	25	1 250	12	TB PSM2			

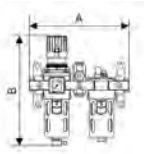
GAMME ALTO 2

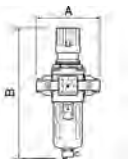
ENSEMBLES DE TRAITEMENT D'AIR COMPRIME G 3/8

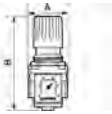
Purge manuelle		Température 5 °C - 60 °C		Matière Cuves avec protection métallique		Matière Corps aluminium		Equipé d'un manomètre 0 à 10 bar		Conditionnement en boîte Ensembles montés	
		A	B	Taraudage Gaz BSP	Filtration μ	Débit maxi en l/min	Pression maxi en bar	REFERENCE			
Filtre régulateur lubrificateur 2 blocs avec manomètre, fixation et entretoise pour sortie air sec											
		204	216	G 3/8	25 - 4 sorties non lubrifiées	1 250	12	TB SME2			
Filtre régulateur avec manomètre et fixation											
		55	220	G 3/8	25	1 800	12	TM SM2			
Filtre régulateur avec manomètre, fixation et connexions rapides											
		113	220	G 3/8	25	1 800	12	TM PSM2			
Régulateur avec manomètre											
		55	135	G 3/8	-	2 500	Entrée:15 Sortie:0.5-10	TR M2			











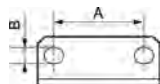

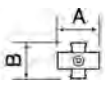
GAMME ALTO 2

MODULES G 3/8

Purge manuelle Réf. TM D2 : purge automatique		Température 5 - 60 °C Réf. TM D2 : 5 - 50° C			Matière Cuves avec protection métallique		Présentation des modules en boîte individuelle		Matière Corps aluminium		
		A	B	C	Débit maxi en l/min	Filtration μ	Pression maxi en bar	Taraudage Gaz BSP	REFERENCE		
Filtre											
		55	140		2 250	25	12	G 3/8	TF 2		
		55	140		2 250	5	12	G 3/8	TF 205		
Régulateur											
						Raccordement manomètre : G 1/8					
		55	135		2 500	-	Entrée:15 Sortie:0.5-10	G 3/8	TR 2		
Lubrificateur											
		55	157		3 000	-	12	G 3/8	TL 2		
Filtre-régulateur											
		55	220		1 800	25	Entrée:12 Sortie:0.5-10	G 3/8	TM 2		
		55	220		1800	25 Avec purge automatique	Entrée: 2-12 Sortie: 0.5-10	G 3/8	TM D2		
Entretoise pour sorties non lubrifiées											
		66	35	53	-	4 sorties air sec	-	G 3/8	TE 2		

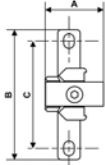
GAMME ALTO 2

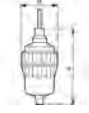
ACCESSOIRES

		A	B	C	DESIGNATION	REFERENCE
Equerre de fixation						
		40	6.5		Pour filtre ou lubrificateur G 3/8	TP Q2
		40	6.5		Pour régulateur ou filtre régulateur G 3/8	TR Q2
		-	-		Ecrou pour équerre de régulateur	TR E2
Jeu d'assemblage						
		29	33		1 jeu TA M2 pour 2 modules G 3/8 2 jeux TA M2 pour 3 modules G 3/8	TA M2
Jeu d'assemblage et de fixation murale						
		70			1 jeu TA S2 pour 2 modules G 3/8 2 jeux TA S2 pour 3 modules G 3/8	TA S2
Connexion rapide sur réseau						
		29			G 3/8	TC P2
Jeu de fixation murale et connexion réseau						
		40	89	70	G 3/8	TC S2
Purge automatique à flotteur						
		120			Pour filtre G 3/8	TD F2
Cartouche filtrante pour filtres ALTO 2						
					Cartouche filtrante 25 µ	TF C2
					Cartouche filtrante 5 µ	TF C205
Purge manuelle						
					Pour filtres et filtres régulateurs G 1/8 - G 1/4 - G 3/8 - G 1/2 - G 3/4 - G 1	TP F45

UNITÉ DE TRAITEMENT D'AIR

ALTO 3 - G 1/2

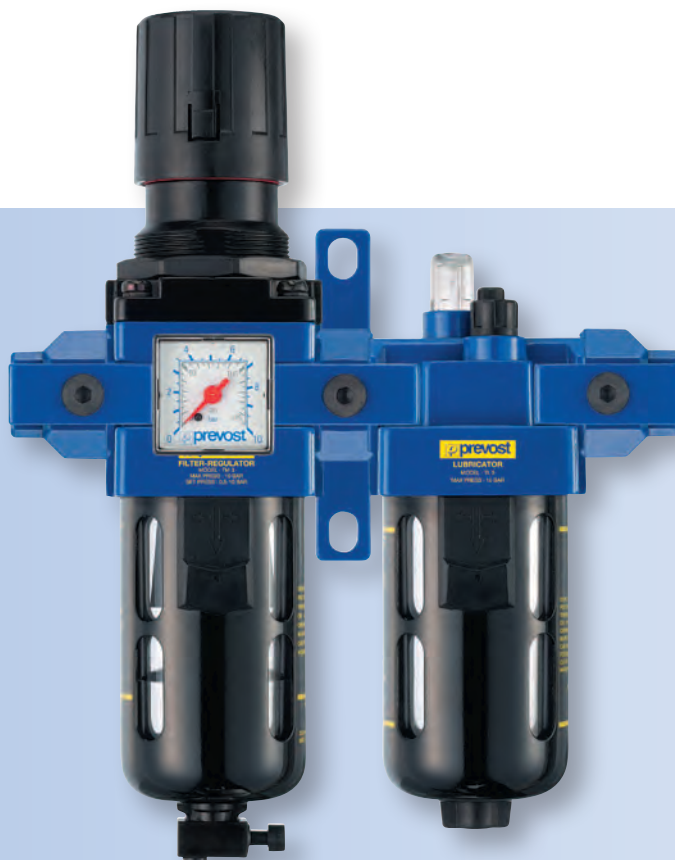

PERFORMANCES ET CARACTÉRISTIQUES TECHNIQUES

FILTRE

Cartouche filtrante : Bronze fritté
 Filtration : 25 microns
 Purge : manuelle par pression sur le bouton de drainage
 Capacité de la cuve : 44 ml
 Poids : 0,67 kg

REGULATEUR

Régulateur à membrane, de type progressif
 Pression compensée par valve de régulation
 Raccordement manomètre : G 1/8
 Poids : 0,90 kg

LUBRIFICATEUR

Lubrification par brouillard d'huile
 Réglage du débit d'huile par vis pointeau
 Capacité de la cuve : 152 ml
 Poids : 0,56 kg
 Huile recommandée : ISO VG 22 - Ref. VAS 2442 (p. 339)

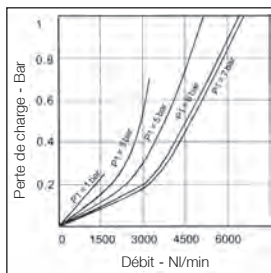

Filtre

Pression d'entrée : 6 bar
 ΔP : 0,3 bar

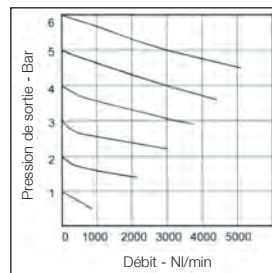

Filtre Régulateur

Pression d'entrée : 7 bar
 Pression de service : 6 bar
 Perte de charge ΔP : 0,3 bar

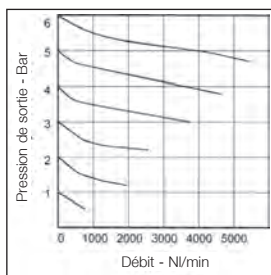

Régulateur

Pression d'entrée : 7 bar
 Pression de service : 6 bar
 Perte de charge ΔP : 0,3 bar

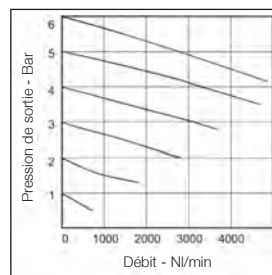

Filtre Régulateur Lubrificateur 2 blocs

Pression d'entrée : 7 bar
 Pression de service : 6 bar
 Perte de charge ΔP : 0,3 bar

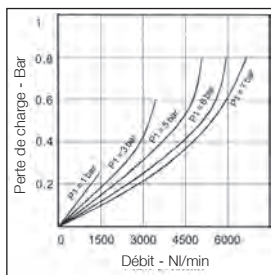

Lubrificateur

Pression d'entrée : 6 bar
 ΔP : 0,5 bar

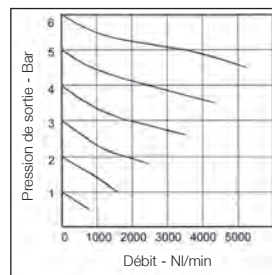







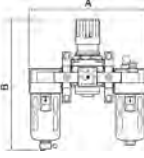

Filtre Régulateur Lubrificateur 3 blocs

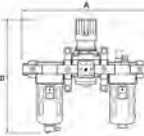
Pression d'entrée : 7 bar
 Pression de service : 6 bar
 Perte de charge ΔP : 0,3 bar

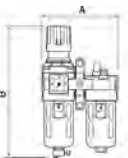
GAMME ALTO 3

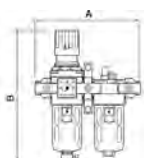
ENSEMBLES DE TRAITEMENT D'AIR COMPRIME G 1/2

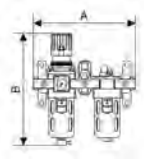
Purge manuelle		Température 5 - 60 °C		Matière Cuves avec protection métallique		Equipé d'un manomètre 0 à 10 bar		Matière Corps aluminium		Conditionnement en boîte Ensembles montés	
		A	B	Débit maxi en l/min	Filtration μ	Pression maxi en bar	Taraudage Gaz BSP	REFERENCE			
Filtre régulateur lubrificateur 3 blocs avec manomètre et fixation											
		241	280	3 500	25	12	G 1/2	TT SM3			
Filtre régulateur lubrificateur 3 blocs avec manomètre, fixation et connexions rapides											
		305	280	3 500	25	12	G 1/2	TT PSM3			
Filtre régulateur lubrificateur 2 blocs avec manomètre et fixation											
		156	280	2 800	25	12	G 1/2	TB SM3			
Filtre régulateur lubrificateur 2 blocs avec manomètre, fixation et connexions rapides											
		220	280	2 800	25	12	G 1/2	TB PSM3			
Filtre régulateur lubrificateur 2 blocs avec manomètre, fixation et entretoise pour sortie air sec											
		245	277	2800	25 - 4 sorties non lubrifiées	10	G 1/2	TB SME3			

GAMME ALTO 3

ENSEMBLES DE TRAITEMENT D'AIR COMPRIME G 1/2

Purge manuelle		Température 5 - 60 °C		Matière Cuves avec protection métallique		Equipé d'un manomètre 0 à 10 bar		Matière Corps aluminium		Conditionnement en boîte Ensembles montés	
		A	B	Débit maxi en l/min	Filtration μ	Pression maxi en bar	Taraudage Gaz BSP	REFERENCE			
Ensemble microfiltre avec régulateur, manomètre et fixation											
		156	280	3 000	5 et 0,01 μ	12	G 1/2	TB CSM3			
Filtre régulateur avec manomètre et fixation											
		70	280	3 000	25	12	G 1/2	TM SM3			
Filtre régulateur avec manomètre, fixation et connexions rapides											
		134	280	3 000	25	12	G 1/2	TM PSM3			
Régulateur avec manomètre											
		70	135	4 000	-	Entrée:15 Sortie:0.5-10	G 1/2	TR M3			











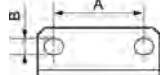

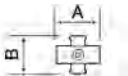
GAMME ALTO 3

MODULES G 1/2

Purge manuelle Réf. TM D3 : purge automatique		Température 5 - 60 °C Réf. TM D3 : 5 - 50°C			Matière Cuves avec protection métallique		Présentation des modules en boîte individuelle		Matière Corps aluminium	
		A	B	C	Débit maxi en l/min	Filtration μ	Pression maxi en bar	Taraudage Gaz BSP	REFERENCE	
Filtre et micro filtre										
		70	172		3 500	25	12	G 1/2	TF 3	
		70	172		3 500	5	10	G 1/2	TF 305	
		70	172		3 000	0,01	12	G 1/2	TC 3	
Régulateur										
		Raccordement manomètre : G 1/8								
		70	165		4 000	-	Entrée:15 Sortie:0.5-10	G 1/2	TR 3	
		70	165		4 000	-	Entrée : 15 Sortie : 0,2-2	G 1/2	TR B23	
		70	165		3 000	-	Entrée : 15 Sortie : 0,2-4	G 1/2	TR B43	
Lubrificateur										
		70	190		5 650	-	12	G 1/2	TL 3	
		70	190		5 650	-	Module avec cuve métal Pression = 20 bar	G 1/2	TL A3	
Filtre-régulateur										
		70	280		3 000	25	Entrée:12 Sortie:0.5-10	G 1/2	TM 3	
		70	280		3 000	5	Entrée:12 Sortie:0.5-10	G 1/2	TM 305	
		70	280		3 000	5	Entrée: 20 Sortie: 0.5-10 Module avec cuve métal	G 1/2	TM A305	
		70	280		3 000	25 Avec purge automatique	Entrée: 2-12 Sortie: 0.5-10	G 1/2	TM D3	
Entretoise pour sorties non lubrifiées										
		83	40	67	-	4 sorties air sec	-	G 1/2	TE 3	

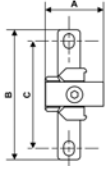
GAMME ALTO 3

ACCESSOIRES

		A	B	C	DESIGNATION	REFERENCE
Equerre de fixation						
		55	8.5		Pour filtre ou lubrificateur G 1/2	TP Q3
		55	8.5		Pour régulateur ou filtre régulateur G 1/2	TR Q3
		-	-		Ecrou pour équerre de régulateur	TR E3
Jeu d'assemblage						
		32	44		1 jeu TA M3 pour 2 modules G 1/2 2 jeux TA M3 pour 3 modules G 1/2	TA M3
Jeu d'assemblage et de fixation murale						
		90			1 jeu TA S3 pour 2 modules G 1/2 2 jeux TA S3 pour 3 modules G 1/2	TA S3
Connexion rapide sur réseau						
		32			G 1/2	TC P3
		-			G 3/4	TC P34
Jeu de fixation murale et connexion réseau						
		48	109	91	G 1/2	TC S3
		74	108	90	G 3/4	TC S34
Purge automatique à flotteur						
		120			Pour filtres G 1/2 - G 3/4 - G 1	TD F3
Cartouche filtrante pour filtres et micro filtre ALTO 3						
					Cartouche filtrante 25 µ	TF C3
					Cartouche filtrante 5 µ	TF C305
					Cartouche filtrante 0.01 µ	TF C301
Purge manuelle						
					Pour filtres et filtres régulateurs G 1/8 - G 1/4 - G 3/8 - G 1/2 - G 3/4 - G 1	TP F45

UNITÉ DE TRAITEMENT D'AIR

ALTO 4 - G 3/4



PERFORMANCES ET CARACTÉRISTIQUES TECHNIQUES

FILTRE

Cartouche filtrante : Bronze fritté
Filtration : 25 microns
Purge : manuelle par pression
sur le bouton de drainage
Capacité de la cuve : 165 ml
Poids : 1,4 kg

RÉGULATEUR

Régulateur à membrane,
de type progressif
Pression compensée par
valve de régulation
Raccordement manomètre : G 1/4
Poids : 1,4 kg

LUBRIFICATEUR

Lubrification par brouillard d'huile
Réglage du débit d'huile par vis
pointeau
Capacité de la cuve : 165 ml
Poids : 1,3 kg
Huile recommandée :
ISO VG 22 - Ref. VAS 2442 (p. 339)

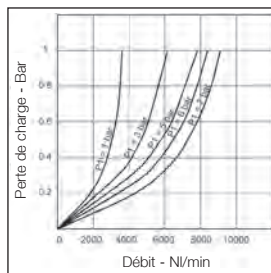

Filtre

Pression
d'entrée : 6 bar
 ΔP : 0,3 bar

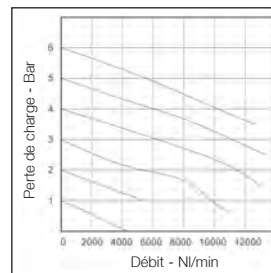

Filtre Régulateur Lubrificateur 3 blocs

Pression
d'entrée : 7 bar
Pression de
service : 6 bar
Perte de charge
 ΔP : 0,3 bar

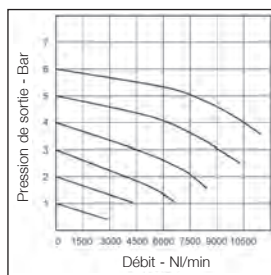

Régulateur

Pression
d'entrée : 7 bar
Pression de
service : 6 bar
Perte de charge
 ΔP : 0,3 bar

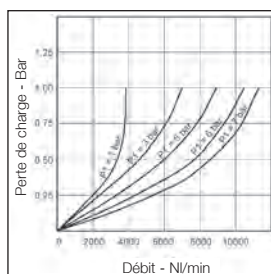

Lubrificateur

Pression
d'entrée : 6 bar
 ΔP : 0,5 bar

UNITÉ DE TRAITEMENT D'AIR

ALTO 4 - G1



PERFORMANCES ET CARACTÉRISTIQUES TECHNIQUES

FILTRE

Cartouche filtrante : Bronze fritté
Filtration : 25 microns
Purge : manuelle par pression
sur le bouton de drainage
Capacité de la cuve : 165 ml
Poids : 1,3 kg

RÉGULATEUR

Régulateur à membrane,
de type progressif
Pression compensée par
valve de régulation
Raccordement manomètre : G 1/4
Poids : 1,3 kg

LUBRIFICATEUR

Lubrification par brouillard d'huile
Réglage du débit d'huile par vis
pointeau
Capacité de la cuve : 165 ml
Poids : 1,2 kg
Huile recommandée :
ISO VG 22 - Ref. VAS 2442 (p. 339)

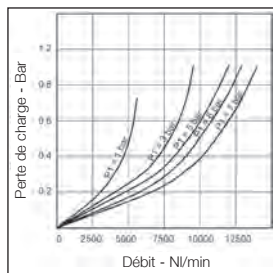

Filtre

Pression
d'entrée : 6 bar
 ΔP : 0,3 bar

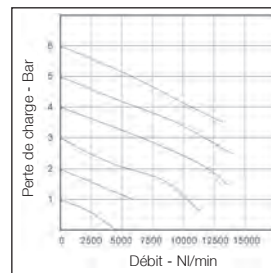

Filtre Régulateur Lubrificateur 3 blocs

Pression
d'entrée : 7 bar
Pression de
service : 6 bar
Perte de charge
 ΔP : 0,3 bar

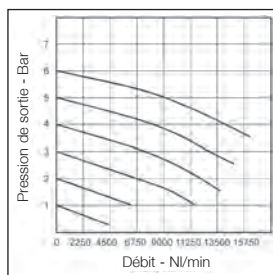

Régulateur

Pression
d'entrée : 7 bar
Pression de
service : 6 bar
Perte de charge
 ΔP : 0,3 bar

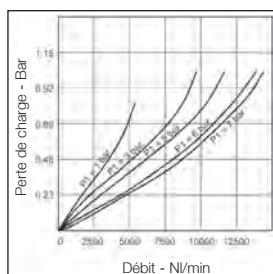







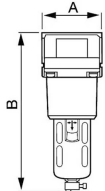

Lubrificateur

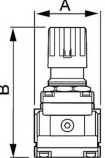
Pression
d'entrée : 6 bar
 ΔP : 0,5 bar



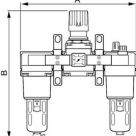

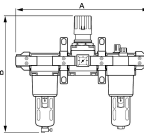



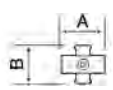

GAMME ALTO 4

ENSEMBLES DE TRAITEMENT AIR COMPRIME - G 3/4 - G 1

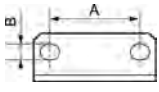





Température 5 à 60 °C		Matière Corps Aluminium			Purge manuelle		Matière Cuves avec protection métallique	
		A	B	Débit Maxi en l/min	Filtration μ	Taraudage Gas BSP	Pression Max. en bar	REFERENCE
Filtre								
		90	260	5 000	25	G 3/4	12	TF 4
		90	260	6 500	25	G 1	12	TF 5
Régulateur								
		Raccordement manomètre : G 1/4						
		90	177	5 000	-	G 3/4	Entrée: 15 Sortie: 0.5-10	TR 4
		90	177	6 000	-	G 1	Entrée: 15 Sortie: 0.5-10	TR 5
Lubrificateur								
		90	273	7 200	-	G 3/4	12	TL 4
		90	273	9 000	-	G 1	12	TL 5
Ensemble 3 blocs filtre mano-régulateur lubrificateur avec équerres de fixation								
		295	360	5 000	25	G 3/4	12	TT SM4
		295	360	6 000	25	G 1	12	TT SM5
Ensemble 3 blocs avec équerres de fixation et connexions rapides pour réseau								
		370	360	5 000	25	G 3/4	12	TT PSM4
		370	360	6 000	25	G 1	12	TT PSM5

GAMME ALTO 4

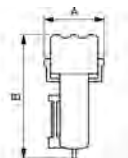
ACCESSOIRES

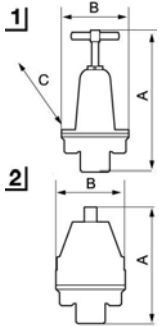
		A	B	DESIGNATION	REFERENCE
Jeu d'assemblage et de fixation murale pour ensembles G 3/4 - G 1					
		124		1 jeu TA S45 pour montage et fixation de 2 ensembles 2 jeux TA S45 pour montage et fixation de 3 ensembles	TA S45
Jeu d'assemblage pour ensembles G 3/4 - G 1					
		50	55	1 jeu TA M45 pour assemblage de 2 modules 2 jeux TA M45 pour assemblage de 3 modules	TA M45
Equerre de fixation pour unités G 3/4 - G 1					
		66	8.3	Equerre de fixation pour filtre et lubrificateur	TP Q45
		66	11	Equerre de fixation pour régulateur	TR Q45
Connexion rapide pour montage des unités G 3/4 - G 1 sur réseau					
		38		Adaptateur rapide pour unité G 3/4	TC P4
		38		Adaptateur rapide pour unités G 1	TC P5
Cartouche filtrante					
				Cartouche filtrante 25 µ	TF C45
Purge automatique à flotteur					
		120		Pour filtres G 1/2 - G 3/4 - G 1	TD F3
Purge manuelle					
				Pour filtres et filtres régulateurs G 1/8 - G 1/4 - G 3/8 - G 1/2 - G 3/4 - G 1	TP F45

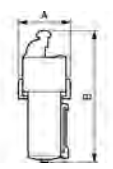
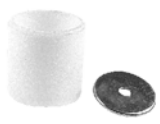
GAMME ALTO MAX - G 1 1/4 à G 2 1/2

Filtration 40 µ		Température 0 à 70°C		Matière Zamac		Filetage G 1 1/4 à G 2 1/2		Purge manuelle	
		A	B	C	Capacité de la cuve - l	Débit l/min	Pression en bar	Entrée Sortie	REFERENCE
Filtre Alto Max avec cuve métallique									
		132	240		0,48	11 000	17	G 1 1/4	TX F42
		132	240		0,48	11 000	17	G 1 1/2	TX F49
		160	281		0,77	30 000	17	G 2	TX F60
		160	281		0,77	30 000	17	G 2 1/2	TX F76
Régulateur Alto Max									
									
		273	127	180	-	12 000	Entrée:21 Sortie:0-9	G 1 1/4	TX RG42
		273	127	180	-	12 000	Entrée:21 Sortie:0-9	G 1 1/2	TX RG49
		310	185	190	-	34 000	Entrée:21 Sortie:0-9	G 2	TX RG60
		330	185	200	-	34 000	Entrée:21 Sortie:0-9	G 2 1/2	TX RG76
Lubrificateur Alto Max									
		122	286		0,48	14 000	17	G 1 1/4	TX L42
		122	286		0,48	14 000	17	G 1 1/2	TX L49
		140	330		0,77	30 000	17	G 2	TX L60
Cartouche filtrante									
					40 µ - TX F42 à TX F49				TX CAFG1
					40 µ - TX F60 à TX F76				TX CAFG2
Purge automatique pour filtres Alto Max									
					Purge automatique à flotteur (en option)				MCP 500

ENSEMBLES DE TRAITEMENT D'AIR SUR PORTIQUE



Prêt à l'emploi		Longévité		Solution simple		Equippé de raccords et embout			Facilement transportable	
		A	B	Filtration μ	Débit maxi en l/min	Pression maxi en bar	Sortie Raccords	Taraudage Gaz BSP	Entrée 1 embout	REFERENCE
Ensemble Filtre régulateur lubrificateur TB SME3 avec manomètre et entretoise pour sortie air sec sur portique										
		303	417	25 μ	2 800	12	3 x ISI06 ISO B	G 1/2	1 x IRP 06	PTE IS
		303	417	25 μ	2 800	12	3 x ESI 07 Européen	G 1/2	1 x ERP 07	PTE ES
		303	417	25 μ	2 800	12	3 x CSM06 ISO C	G 1/2	1 x CRP 06	PTE CM6
		303	417	25 μ	2 800	12	3 x CSM08 ISO C	G 1/2	1 x CRP 08	PTE CM8
Ensemble Microfiltre régulateur TB CSM3 avec manomètre sur portique - Application peinture										
		303	417	5 et 0.01 μ	3 000	12	2 x ISI06 ISO B	G 1/2	1 x IRP 06	PTC IS
		303	417	5 et 0.01 μ	3 000	12	2 x ESI 07 Européen	G 1/2	1 x ERP 07	PTC ES
		303	417	5 et 0.01 μ	3 000	12	2 x CSM06 ISO C	G 1/2	1 x CRP 06	PTC CM6
		303	417	5 et 0.01 μ	3 000	12	2 x CSM08 ISO C	G 1/2	1 x CRP 06	PTC CM8
Ensemble Filtre régulateur lubrificateur TT SM4 avec manomètre et piquage pour sortie air sec - Industrie et PL/TP										
		448	522,6	25 μ	5 000	12	2 x ISG11 1 x ISI06 ISO B	G 3/4	1 x IRP 11	PTE LIS
		448	522,6	5 μ	5 000	12	2x CSM11 1x CSM08 ISO C	G 3/4	1 x CRP 11	PTE LCM11
Equerre murale pour portiques										
	Adapté pour les 2 modèles de portiques : standard et extra large									PT K
Roulettes pour portiques										
	Ensemble de 4 roulettes									PT RL

HUILE POUR OUTILS PNEUMATIQUES

		DESIGNATION	REFERENCE
Huile pneumatique			
		Huile minérale Norme ISO : VG 22 Viscosité à 40° C : 20 cSt (centistokes) Viscosité à 100° C : 4.1 cSt Densité : 0.86 Index de viscosité : 104 Point d'éclair VO supérieur à 200° C Point d'écoulement inférieur à - 9° C Lubrifiant recommandé pour contact avec caoutchouc, élastomère et autres matériaux polymères.	VAS 2442
		Huile minérale ISO VG 22 pour circuits d'air comprimé, lubrificateurs, outillages pneumatiques. Bidon de 2 litres	

MANOMETRES

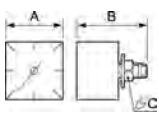
Précision ± 2% de la valeur maxi	Mesure Tube de Bourdon CU SN8 métal	Température -20°C +60°C	Raccordement Laiton	Etanchéité immédiate Bague Téflon
-------------------------------------	--	----------------------------	------------------------	--------------------------------------

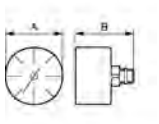
		A	B	C	DESIGNATION	REFERENCE
Manomètre boîtier carré 40 x 40 mm						
					Fixation dorsale pré-étanche G 1/8 Gaz BSP. Cadran plexiglass.	
		40	47	14	0 - 4 bar	MT CA0440
		40	47	14	0 - 6 bar	MT CA0640
		40	47	14	0 - 10 bar	MT CA1040
		40	47	14	0 - 16 bar	MT CA1640
Manomètre boîtier rond Ø 23 mm						
					Fixation dorsale G 1/8 Gaz BSP. Cadran plexiglass.	
		23	23		0 - 12 bar	MT RA1023

MANOMETRES

Précision ± 2% de la valeur maxi		Mesure Tube de Bourdon CU SN8 métal		Température -20°C +60°C		Raccordement Laiton		Etanchéité immédiate Bague Téflon	
		A	B	C	DESIGNATION	REFERENCE			
Manomètre boîtier rond Ø 40 mm									
					Fixation dorsale pré-étanche G 1/8 Gaz BSP. Cadran plexiglass.				
		40	41	14	0 - 2,5 bar	MT RA0240			
		40	41	14	0 - 4 bar	MT RA0440			
		40	41	14	0 - 10 bar	MT RA1040			
		40	41	14	0 - 16 bar	MT RA1640			
Manomètre boîtier rond Ø 50 mm									
					Fixation dorsale pré-étanche G 1/4 Gaz BSP. Cadran plexiglass				
		50	43	14	0 - 4 bar	MT RA0450			
		50	43	14	0 - 10 bar	MT RA1050			
		50	43	14	0 - 25 bar	MT RA2550			
Manomètre boîtier rond Ø 63 mm									
					Fixation dorsale pré-étanche G 1/4 Gaz BSP. Cadran plexiglass				
		63	43	14	0 - 2,5 bar	MT RA0263			
		63	43	14	0 - 10 bar	MT RA1063			
		63	43	14	0 - 16 bar	MT RA1663			
Manomètre boîtier rond-fixation radiale "six heures"									
					Pré-étanche G 1/8 Gaz. Cadran plexiglass Ø 50 mm				
		50	67	28	0 - 4 bar	MT RS0450			
		50	67	28	0 - 10 bar	MT RS1050			

MANOMETRES

Précision ± 2% de la valeur maxi		Mesure Tube de Bourdon CU SN8 métal			Température -20°C +60°C		Raccordement Laiton		Etanchéité immédiate Bague Téflon	
		A	B	C	DESIGNATION				REFERENCE	
Manomètre boîtier rond fixation radiale "six heures" G 1/4										
		50	67	28	Pré-étanche G 1/4. Cadran plexiglass Ø 50 mm					
		50	67	28	0 - 12 bar				MT RS1250	
					0 - 16 bar				MT RS1650	
Manomètre intégrable à collerette ronde Ø 40 mm										
		50	49	14	Fixation dorsale pré-étanche G 1/8 Gaz BSP					
					Cadran verre compatible solvant Ø 40 mm - 0 - 10 bar				MT IA1040V	
Manomètre intégrable à collerette ronde Ø 50 mm										
		60	49	14	Fixation dorsale pré-étanche G 1/8 Gaz BSP					
					Cadran verre compatible solvant Ø 50 mm - 0 - 6 bar				MT IA0650V	
		60	49	14	Cadran verre compatible solvant Ø 50 mm - 0 - 10 bar				MT IA1050V	
Manomètre intégrable à collerette ronde Ø 63 mm										
		72	52	14	Fixation dorsale pré-étanche G 1/4 Gaz BSP					
					Cadran verre compatible solvant Ø 63 mm - 0 - 10 bar				MT IA1063V	
		72	52	14	Cadran verre compatible solvant Ø 63 mm - 0 - 16 bar				MT IA1663V	
Manomètre à bain de glycerine rond Ø 63 mm										
		68	29	89	Fixation radiale G 1/4 Gaz BSP. Boîtier et bague en acier inox. Spécialement adapté aux appareils soumis à de fortes vibrations.					
					0 - 16 bar				MT GA1365	

FILTRE

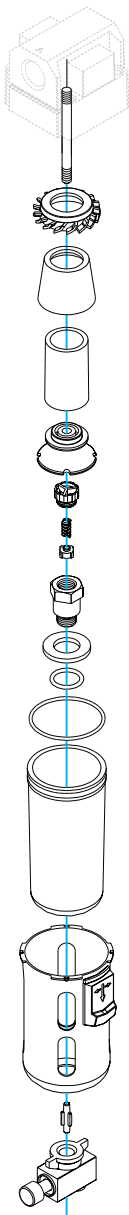

Pièces détachées disponibles
en 2 kits, voir page 351.

RÉGULATEUR

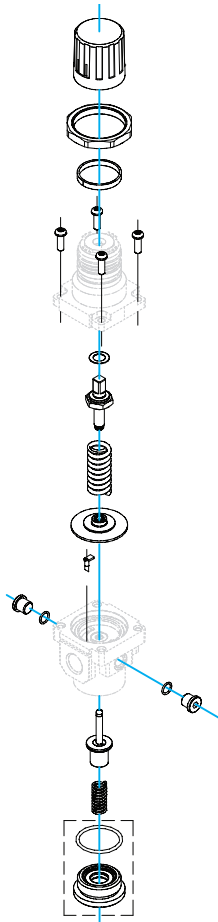

Pièces détachées disponibles
en 3 kits, voir page 352.

LUBRIFICATEUR

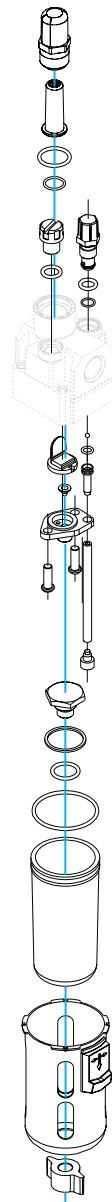

Pièces détachées disponibles
en 3 kits, voir page 353.

FILTRE / RÉGULATEUR

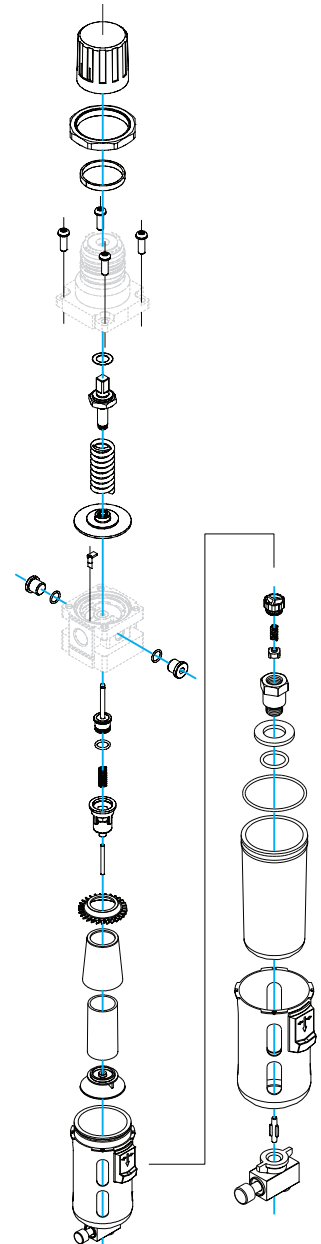

Pièces détachées disponibles
en 4 kits, voir pages 354 - 355.

FILTRE

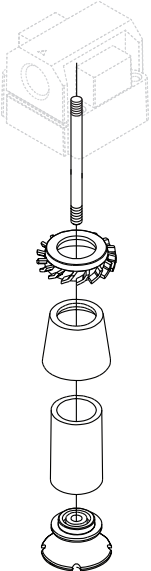
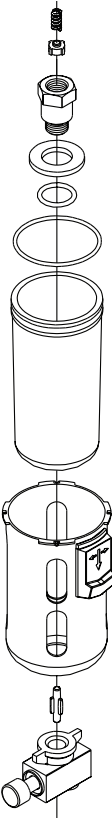
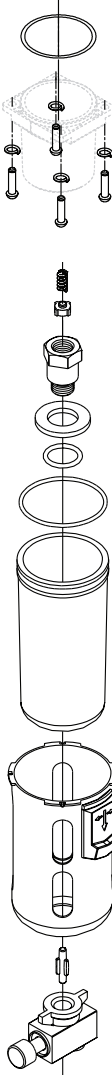
	ALTO 1 G 1/8 - G 1/4			ALTO 2 G 3/8		ALTO 3 G 1/2	
	TF 0 - TF 1	TF 2	TF 3			ALTO 4 G 3/4 - G 1	
	TF 1K1	TF 2K1	TF 3K1			TF 4	TF 5
	TFM 1K2	TFM 2K2	TFM 3K2			TFM 45K2	TFM 45K2
							

RÉGULATEUR

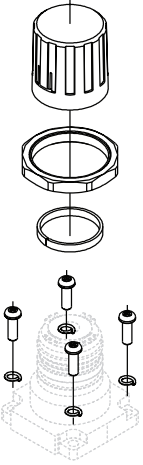
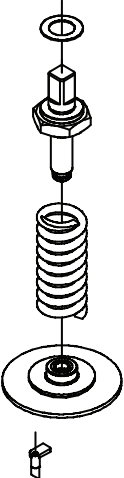
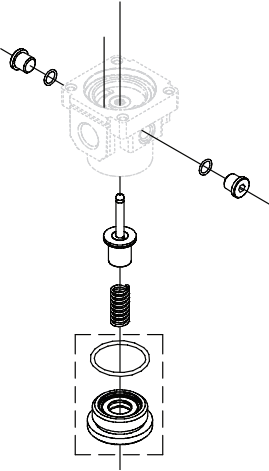
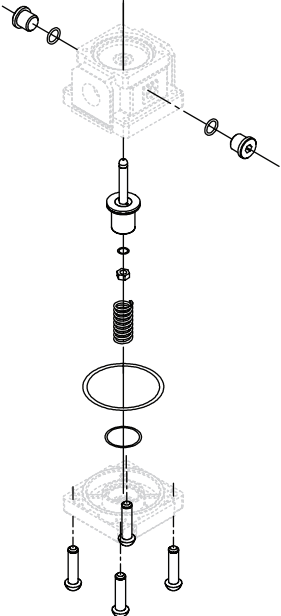
	ALTO 1 G 1/8 - G 1/4	ALTO 2 G 3/8	ALTO 3 G 1/2		ALTO 4 G 3/4 - G 1	
	TR 0 - TR 1	TR 2	TR 3		TR 4	TR 5
	TRM 1K1	TRM 2K1	TRM 345K1		TR M345K1	TR M345K1
	TF 0 - TF 1	TF 2	TF 3		TR 4	TR 5
	TRM 1K2	TRM 2K2	TRM 3K2		TR M45K2	TR M45K2
	TRB 21		TRB 23			
	<i>0.2 - 2 Bar</i>		<i>0.2 - 2 Bar</i>			
	TRM B21K2		TRM B23K2			
	TRB 41		TRB 43			
<i>0.2 - 4 Bar</i>		<i>0.2 - 4 Bar</i>				
TRM B41K2		TRM B43K2				
	TR 0 - TR 1	TR 2	TR 3		TR 4	TR 5
	TR 1K3	TR 2K3	TR 3K3		TR 45K3	TR 45K3

LUBRIFICATEUR

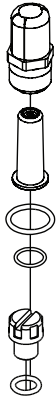
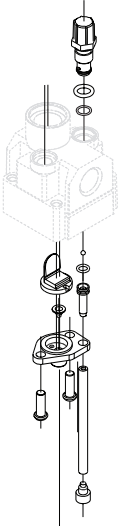
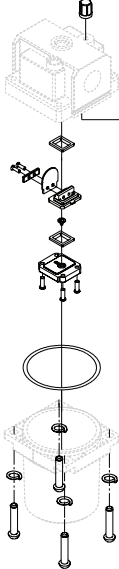
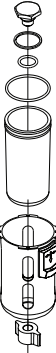
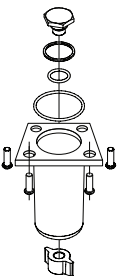
	ALTO 1 G 1/8 - G 1/4	ALTO 2 G 3/8	ALTO 3 G 1/2		ALTO 4 G 3/4 - G 1	
	TL 0 - TL 1	TL 2	TL 3		TL 4	TL 5
	TL 1K1	TL 2K1	TL 345K1		TL 345K1	TL 345K1
	TL 1K2	TL 2K2	TL 3K2		TL 45K2	TL 45K2
	TL 1K3	TL 2K3	TL 345K3		TL 345K3	TL 345K3
			TL A3 <i>Cuve métallique</i> TL A3K3			

FILTRE / RÉGULATEUR

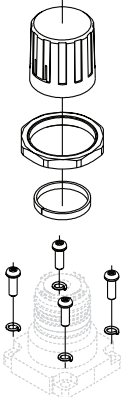
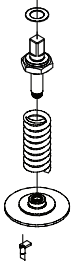
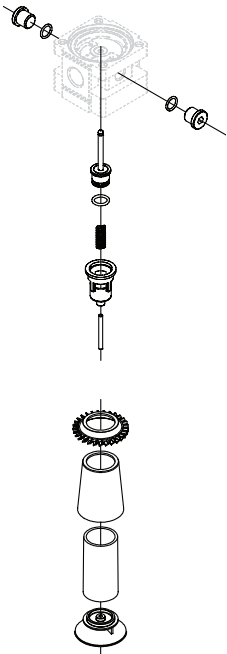
	ALTO 1 G 1/8 - G 1/4	ALTO 2 G 3/8	ALTO 3 G 1/2	ALTO 4 G 3/4 - G 1	
	TM 0 - TM 1	TM 2	TM 3	TM 4	TM 5
	TRM 1K1	TRM 2K1	TRM 345K1	TRM 345K1	TRM 345K1
	TRM 1K2	TRM 2K2	TRM 3K2	TRM 45 K2	TRM 45 K2
	TM 1K3	TM 2K3	TM 3K3	TM 45K3	TM 45K3

FILTRE / RÉGULATEUR

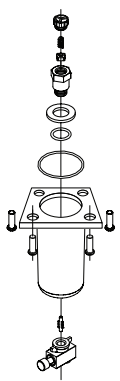
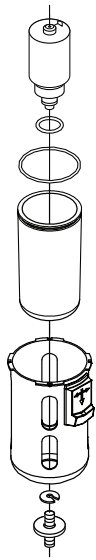
	ALTO 1 G 1/8 - G 1/4	ALTO 2 G 3/8	ALTO 3 G 1/2	ALTO 4 G 3/4 - G 1	
	TM 0 - TM 1	TM 2	TM 3	TM 4	TM 5
	TFM 1K2	TFM 2K2	TFM 3K2	TFM 45K2	TFM 45K2
			TMA 305 <i>Cuve métallique</i> TM A305K4		
		TM D2	TM D3 <i>Filtre à purge automatique</i>		
		TFM D2K4	TFM D3K4		

ASSEMBLAGE ENSEMBLE 2 BLOCS

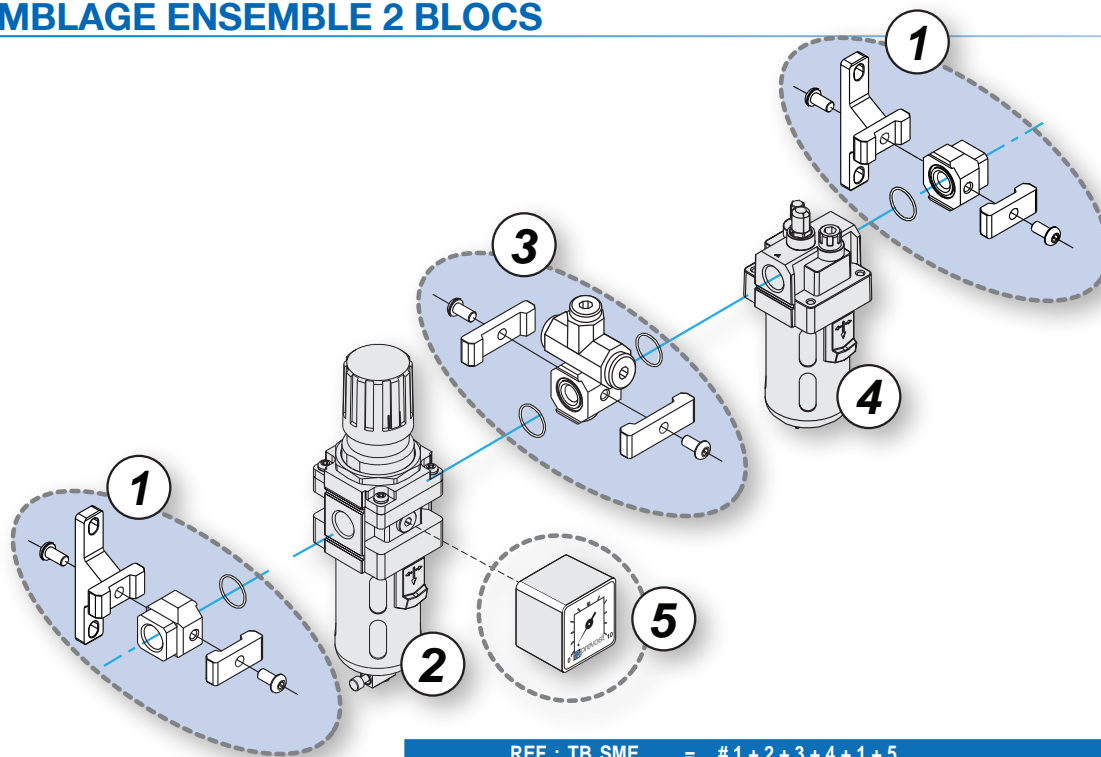

REF : TB SME = # 1 + 2 + 3 + 4 + 1 + 5

	#	G 1/4	G 3/8	G 1/2	G 3/4	G 1
Jeu de fixation murale et connexion réseau	1	TC S1	TC S2	TC S3	TC S4	TC S5
Filtre Régulateur	2	TM 1	TM 2	TM 3	TM 4	TM 5
Entretoise sortie sèche	3	TE 1	TE 2	TE 3		
Lubrificateur	4	TL 1	TL 2	TL 3	TL 4	TL 5
Manomètre	5	MT CA1040	MT CA1040	MT CA1040	MT RA1663	MT RA1663

ASSEMBLAGE ENSEMBLE 3 BLOCS

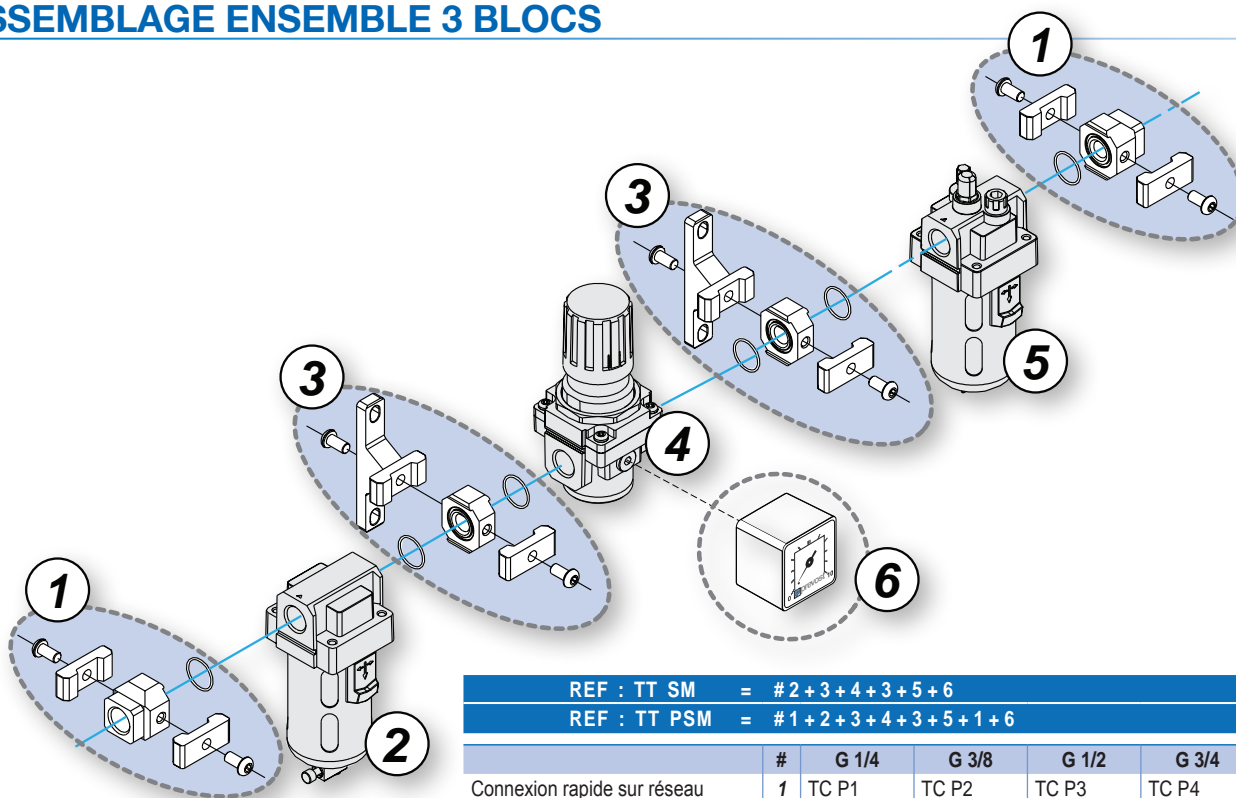

REF : TT SM = # 2 + 3 + 4 + 3 + 5 + 6

REF : TT PSM = # 1 + 2 + 3 + 4 + 3 + 5 + 1 + 6

	#	G 1/4	G 3/8	G 1/2	G 3/4	G 1
Connexion rapide sur réseau	1	TC P1	TC P2	TC P3	TC P4	TCP 5
Filtre	2	TF 1	TF 2	TF 3	TF 4	TF 5
Jeu de fixation murale	3	TA S1	TA S2	TA S3	TA S45	TA S45
Régulateur	4	TR 1	TR 2	TR 3	TR 4	TR 5
Lubrificateur	5	TL 1	TL 2	TL 3	TL 4	TL 5
Manomètre	6	MT CA1040	MT CA1040	MT CA1040	MT RA1663	MT RA1663

micro air

FILTRATION DE L'AIR COMPRIMÉ PAR COALESCENCE

LES FILTRES MICRO AIR

Les filtres Micro Air éliminent les différents agents nocifs, particules solides, particules liquides et aérosols d'huile, contenus dans l'air comprimé, avec un degré d'efficacité supérieur à **99,999 %**. Ils garantissent l'obtention d'un air de haute qualité avec une faible perte de charge.

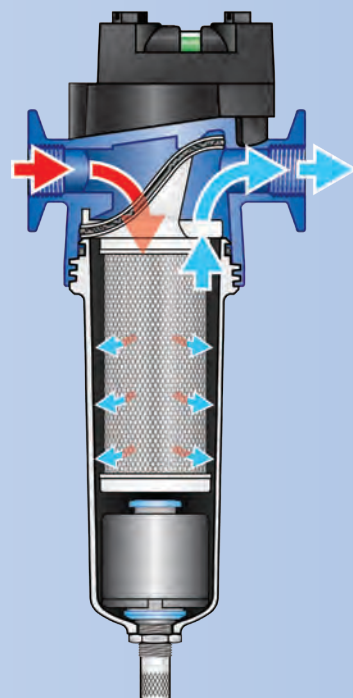

Design et matériaux sont conçus pour :

- ▶ Assurer la filtration nécessaire à un travail de qualité
- ▶ Augmenter la durée de vie des cartouches
- ▶ Diminuer les pertes de charge
- ▶ Faciliter l'installation et la maintenance

Plage de débits : de 34 m³/h à 2 549 m³/h

Raccordements taraudés de G 1/4 à G 3

Tous les matériaux utilisés à la conception des filtres MICRO AIR sont **sans silicone**.

La combinaison huile, poussières et eau, contenues dans l'air comprimé est extrêmement corrosive. Cette pollution est néfaste aux composants du réseau d'air, aux outils pneumatiques utilisés et à la qualité du travail réalisé.

1 Qualité du média filtrant

Le média filtrant de la cartouche utilise différents composants :

- Le média principal **plissé**, en micro fibre de verre borosilicate HEPA, **offre une surface de filtration 4.5 fois supérieure à un média habituel**
- Réduction de 50% des pertes de charges par rapport aux cartouches traditionnelles et 96% de capacité d'évacuation supplémentaire
- Le support structurel est en acier inoxydable
- La gaine à effet drainant en feutre aiguilleté polymère assure une **parfaite coalescence** et présente une **très haute résistance aux huiles de compresseurs**



2 Facilité de changement des cartouches

- Cuve vissée sur la tête du filtre avec joint nitrile résistant aux produits chimiques les plus agressifs
- Épaulement interne dans la tête du filtre pour bloquer la rotation et empêcher l'installation de cartouches de formes différentes
- Signal sonore d'alarme en cas d'ouverture du bol sous pression pour une sécurité maximale
- Corps et tête de filtre moulés en aluminium, protégés par un double revêtement

3 Conception venturi breveté de la cartouche filtrante

- Système d'emboîtement spécialement dessiné pour faciliter le passage de l'air sans turbulence à l'entrée et à la sortie du filtre

- **Amélioration de la fluidité** du passage de l'air
- **Débit optimisé**
- **Diminution de la perte de charge**

- Fixation de la cartouche par emboîtement sur la tête du filtre
- Joint nitrile garantissant un emboîtement sans fuite, même sous variations de températures ou vibrations
- Tête de cartouche unique en fibre de verre renforcée avec couleur d'identification du type de cartouche :



- **Blanche** : filtration 1 µ
- **Verte** : filtration 0,01 µ
- **Noire** : charbon actif

4 Précision des indicateurs de colmatage montés en série

Les indicateurs de colmatage sont des témoins de perte de charge, ils permettent un contrôle simple et immédiat de l'encrassement de la cartouche.

Quand la cartouche de filtration est saturée, donc à changer, les voyants passent en zone rouge (*perte de charge équivalente à 400 mb minimum*).

- ▶ Indicateur de colmatage **MPI 1** du modèle G 1/4 à G 3/4



- ▶ Manomètre différentiel **MPI 2** du modèle G 1 à G 3



5 Efficacité des purges automatiques de condensats

Drainage des condensats sans aucune perte d'air comprimé

- ▶ Purge automatique à flotteur **MPD** pour modèles G 1/4 à G 2
Orifice de bas de cuve: femelle G 1/8
- ▶ Purge électrique à sonde capacitive **MPD X3** pour modèles G 2 1/2 à G 3
Orifice de bas de cuve: femelle G 1/2



6 Rapidité d'assemblage et de fixation

- ▶ Collier d'assemblage **MPA**
 - Assemblage facile et rapide des filtres entre eux par serrage
 - Joints latéraux en nitrile pour une parfaite étanchéité
- ▶ Équerre de fixation **MPK**
 - Montage simple, rapide et en façade des blocs de filtration
 - Pour un filtre: une équerre
 - Pour deux ou plusieurs filtres: deux équerres

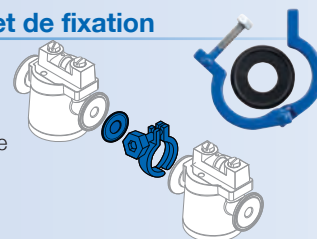

Ensembles	Assemblages MPA	Fixations MPK
G 1/4, G 3/8, G 1/2	MPA 1	MPK 1
G 3/4, G 1	MPA 2	MPK 2
G 1 1/2, G 2	MPA 3	MPK 3
G 2 1/2, G 3	MPA 4	MPK 4

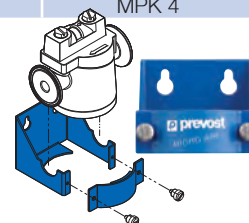

FONCTIONNEMENT

FILTRES TYPE MFM

Filtration micronique par séparation mécanique

Le filtre capte les particules en suspension, les retient à travers le média filtrant et les dirige dans le bol pour évacuation.

- ▶ Purge automatique à flotteur du modèle G 1/4 à G 2
- ▶ Purge automatique à sonde capacitive du modèle G 2 1/2 à G 3

Le filtre MFM :

- Retient les particules liquides et solides d'une taille supérieure à **1µ**
- Retire plus de 99,999 % des particules et plus de 80 % des huiles en suspension
- Assure une teneur en huile résiduelle inférieure à 2 mg par m³ à 20° C et 1 bar absolu, **teneur en huile ≤ 0,5 ppm**
- Classes de qualité
 - Particules : Classe 2
 - Huile : Classe 4

Applications du filtre micronique MFM :

- Préparation générale en tête de réseau
- Préfiltration pour filtres submicroniques
- Postfiltration pour sécheur par adsorption (*filtre à poussières*)



Modèle G 3/4 à G1

FILTRES TYPE MFB

Filtration submicronique par coalescence

La filtration par coalescence s'effectue en deux phases.

- La première phase est de type séparation mécanique, avec une rétention des particules solides par calibrage
- La seconde phase, appelée coalescence, est la réunion des fines gouttelettes d'huile et d'eau en suspension dans le flux d'air. La gaine assure cette phase et réalise le drainage du mélange vers la purge de fond de filtre.
 - ▶ Purge automatique à flotteur du modèle G 1/4 à G 2
 - ▶ Purge automatique à sonde capacitive du modèle G 2 1/2 à G 3

Le filtre submicronique MFB :

- Retient toutes les particules liquides et solides d'une taille supérieure à **0,01µ**
- Retire plus de 99,999 % des particules solides et plus de 99,9% des huiles en suspension
- Assure une teneur en huile résiduelle inférieure à 0,01 mg par m³ à 20° C et 1 bar absolu, **teneur en huile ≤ 0,01 ppm**
- Classes de qualité :
 - Particules : Classe 1
 - Huile : Classe 1

Applications du filtre submicronique MFB :

- Pré-filtre pour les sécheurs à membrane
- Pré-filtre pour filtres à charbon actif
- Pré-filtre pour sécheur par adsorption
- Élément d'une chaîne de traitement pour air respirable
- Air peinture



Modèle G 3/4 à G1

FILTRES TYPE MFC

Filtration par charbon actif

La filtration est faite par absorption des odeurs et goûts par concentration sur la surface du charbon actif de la cartouche.

Le filtre MFC :

- Retient les particules solides d'une taille supérieure à **0,01 µ**
- Assure une teneur en huile résiduelle inférieure à 0,004 mg par m³ (*vapeur d'huile*) à 20° C et 1 bar absolu, **teneur en huile ≤ 0,003 ppm**
- Élimine les odeurs véhiculées dans le flux d'air
- Classes de qualité :
 - Particules : Classe 1
 - Huile : Classe 1

Applications du filtre charbon actif MFC :

- Contact avec produits alimentaires
- Contact avec produits pharmaceutiques
- Air technique, air analyse
- Air peinture (HVLV)
- Élément d'une chaîne de traitement pour air respirable



Modèle G 3/4 à G1

Le filtre à charbon actif doit impérativement être précédé d'un pré-filtre submicronique de déshuilage type MFB. La cartouche d'un filtre charbon actif doit être remplacée lors du changement de la cartouche de son pré-filtre submicronique.

Ce filtre n'agit pas sur le méthane, le monoxyde de carbone, le dioxyde de carbone et autres gaz et vapeurs toxiques.

CARACTÉRISTIQUES TECHNIQUES

Type de filtres Fonction	Filtres type MFM Filtration micronique par séparation mécanique	Filtres type MFB Filtration submicronique par coalescence	Filtres type MFC Filtration par charbon actif - Adsorption
Taille des particules*	1 µ	0,01 µ	0,01 µ
Classe de qualité de l'air selon ISO 8573.1 :2009	Particules solides : 2 Huile : 4	Particules solides : 1 Huile : 1	Particules solides : 1 Huile : 1
Retenue des particules	99,999 %	99,999 %	99,999 %
Retenue des huiles	80 %	99,9 %	-
Teneur huile résiduelle à 20° C et 1 bar absolu	2 mg/m ³	<0,01 mg/m ³	<0,004 mg/m ³ (vapeur d'huile)
Teneur huile résiduelle en ppm	≤ 0,5 ppm	≤ 0,01 ppm	≤ 0,003 ppm
Température mini/maxi	de 1° C à 66° C	de 1° C à 66° C	de 1° C à 66° C
Pression mini d'utilisation	2 bar	2 bar	2 bar
Pression maxi d'utilisation	16 bar 11 bar à partir du modèle G 2 1/2	16 bar 11 bar à partir du modèle G 2 1/2	16 bar 11 bar à partir du modèle G 2 1/2
Pression différentielle d'entrée : Δ P Air sec Δ P Air humide	0,04 bar 0,1 bar	0,04 bar 0,12 bar	0,07 bar -
Couleur des cartouches	Blanche	Verte	Noire
Évacuation des condensats	Purge automatique à flotteur, purge électrique à partir du modèle G 2 1/2	Purge automatique à flotteur, purge électrique à partir du modèle G 2 1/2	-
Changement des cartouches filtrantes	Changement * : 6000 heures ou 1 x an Changement si 400 mb différentiels	Changement * : 3000 heures ou 1 x an Changement si 400 mb différentiels	Changement * : 1000 heures ou 1 x an Changement avec préfiltre (à 20° C d'entrée d'air)

*Particules liquides de 0,01 à 5 µ - Concentration d'entrée d'huile : 10 mg/m³

- La ligne MICRO AIR est testée et certifiée conformément à la norme ISO 12500
- Les valeurs annoncées sont mesurées selon les termes de la norme ISO 12500 (1, 2 et 3)
- Les classes de qualité d'air sont données selon la norme ISO 8573.1 : 2009

Facteurs de correction :

Pour les gammes **MFM**, **MFB** et **MFC**, les débits traités annoncés sont donnés en considérant une pression du réseau à **7 bar**.

La table ci-dessous donne le facteur de correction à appliquer lorsque la pression est différente.

Pression en bar														
2	3	4	5	6	7	8	9	10	11	12	13	14	15	16
0,38	0,52	0,63	0,75	0,88	1	1,13	1,26	1,38	1,52	1,65	1,76	1,87	2	2,14
Facteur de correction														

LES ENSEMBLES DE FILTRATION

SPÉCIAL CARROSSERIE : MBR – MBC – MBCR

Un air dépoussiéré, déshuilé, sans silicone pour obtenir des peintures de qualité.

Ensembles spéciaux de filtration pour pistolets de peinture à base aqueuse :

- Peinture de qualité grâce à une filtration poussée
- Évacuation automatique des polluants par purge à flotteur
- Ensembles livrés montés étanches avec :
 - équerre de fixation murale
 - raccords rapides de sortie d'air

Selon le modèle :

- régulateur de pression avec manomètre
- filtre à charbon actif

Le régulateur permet d'adapter la pression au pistolet utilisé. Il est équipé d'un manomètre à cadran en verre pour éviter les risques de dégâts liés aux solvants ou autres diluants.

Les nouvelles peintures "aquabase" sont très sensibles aux contaminants tels que l'eau, les vapeurs d'huiles et les micro poussières. Le charbon actif représente le traitement optimal de ces agresseurs et les élimine jusqu'à descendre à un niveau résiduel de 0,004 mg/m³ d'air.



Ensembles équipés de raccords prevost

Existents en raccords profils :

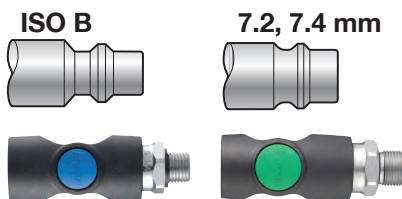

- antistatiques
- fabrication sans silicone
- ATEX 2
- anti-rayure
- anti coup de fouet
- légers et haut débit

Les MBR et MBCR sont à installer au plus près de la cabine pour éviter les risques de contamination entre la filtration et le pistolet. Les ensembles peuvent être montés directement dans la cabine.

APPLICATIONS

Atelier standard classique



Compresseur cuve

Séparateur de condensats SPC

Filtre micronique MFM

Atelier standard de petites industries et de réparation automobile

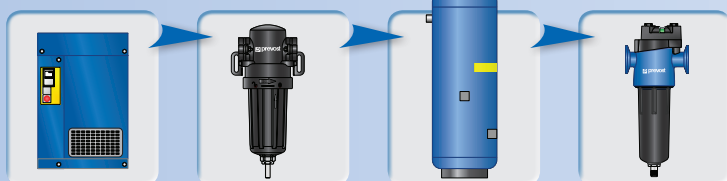

Compresseur

Séparateur de condensats SPC

Cuve

Filtre micronique MFM

Ateliers de peinture, carrosseries

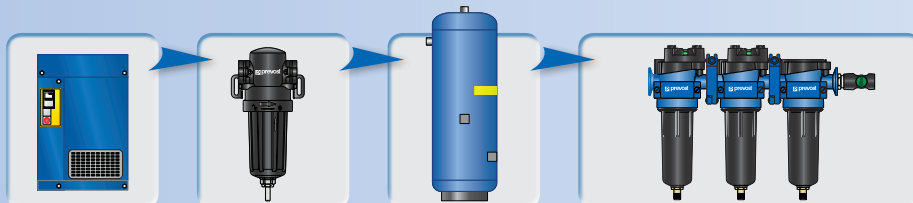

Compresseur

Séparateur de condensats SPC

Cuve

Ensemble de filtration MBC

Protection de sécheurs par réfrigération / Stockage d'un air sec et dépeussière



Compresseur

Séparateur de condensats SPC

Sécheur par réfrigération ALF

Filtre micronique MFM

Cuve

Protection de sécheurs par adsorption / Stockage d'un air exempt de poussières, d'eau et d'huile



Compresseur

Séparateur de condensats SPC

Filtre micronique MFM



Filtre submicronique de déshuilage MFB

Sécheur par adsorption ALC

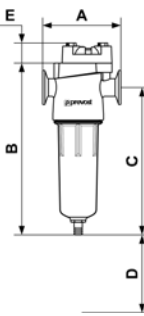

Filtre micronique MFM

Cuve

SERIE MFM - FILTRE MICRONIQUE

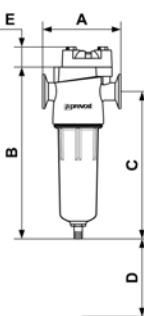

Filtration 1 μ		Efficacité 99,999 %				Indicateur de colmatage		Pression P.N. 16 bar			
		A	B	C	D	E	Débit sous 7 bar m ³ /h	Taraudage Gaz BSP	Référence de la cartouche de rechange	REFERENCE	
Filtration de base MFM - filtration 1 μ											
							Seuil de filtration : 1 μ Teneur en huile < 0,5 ppm				
		113,6	205,5	171,4	102,0	30,0	34	G 1/4		MFMC 101	MFM 101
		113,6	205,5	171,4	102,0	30,0	59	G 3/8		MFMC 102	MFM 102
		113,6	252,0	216,4	102,0	30,0	85	G 1/2		MFMC 103	MFM 103
		132,0	262,1	219,8	127,0	30,0	127	G 3/4		MFMC 104	MFM 104
		132,0	262,1	219,8	127,0	30,0	175	G 3/4		MFMC 105	MFM 105
		132,0	326,1	238,8	127,0	60,0	267	G 1		MFMC 106	MFM 106
		200,0	336,7	276,1	178,0	60,0	437	G 1 1/2		MFMC 107	MFM 107
		200,0	433,7	373,1	178,0	60,0	612	G 1 1/2		MFMC 108	MFM 108
		200,0	566,0	505,4	178,0	60,0	681	G 2		MFMC 109	MFM 109
		230,8	634,4	550,0	204,0	60,0	993	G 2 1/2		MFMC 110	MFM 110
		230,8	634,4	550,0	204,0	60,0	1317	G 2 1/2		MFMC 111	MFM 111
		230,8	634,4	550,0	204,0	58,0	1750	G 2 1/2		MFMC 112	MFM 112
		230,8	817,1	732,7	204,0	60,0	2039	G 3		MFMC 113	MFM 113
230,8	1085,1	1000,7	204,0	60,0	2549	G 3	MFMC 114	MFM 114			

SERIE MFB - FILTRE SUBMICRONIQUE

Efficacité 99,999 %		Filtration 0,01 μ				Indicateur de colmatage		Pression P.N. 16 bar			
		A	B	C	D	E	Débit sous 7 bar m ³ /h	Taraudage Gaz BSP	Référence de la cartouche de rechange	REFERENCE	
Filtration submicronique MFB - filtration par coalescence 0.01 μ											
							Seuil de filtration : 0.01 μ Teneur en huile 0,01 ppm				
		113,6	205,5	171,4	102,0	30,0	34	G 1/4		MFBC 201	MFB 201
		113,6	205,5	171,4	102,0	30,0	59	G 3/8		MFBC 202	MFB 202
		113,6	252,0	216,4	102,0	30,0	85	G 1/2		MFBC 203	MFB 203
		132,0	262,1	219,8	127,0	30,0	127	G 3/4		MFBC 204	MFB 204
		132,0	262,1	219,8	127,0	30,0	175	G 3/4		MFBC 205	MFB 205
		132,0	326,1	238,8	127,0	60,0	267	G 1		MFBC 206	MFB 206
		200,0	336,7	276,1	178,0	60,0	437	G 1 1/2		MFBC 207	MFB 207
		200,0	433,7	373,1	178,0	60,0	612	G 1 1/2		MFBC 208	MFB 208
		200,0	566,0	505,4	178,0	60,0	681	G 2		MFBC 209	MFB 209
		230,8	634,4	550,0	204,0	60,0	993	G 2 1/2		MFBC 210	MFB 210
		230,8	634,4	550,0	204,0	60,0	1317	G 2 1/2		MFBC 211	MFB 211
		230,8	634,4	550,0	204,0	60,0	1750	G 2 1/2		MFBC 212	MFB 212
		230,8	817,1	732,7	204,0	60,0	2039	G 3		MFBC 213	MFB 213
230,8	1085,1	1000,7	204,0	60,0	2549	G 3	MFBC 214	MFB 214			

SERIE MFC - FILTRE CHARBON ACTIF

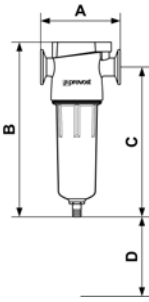
Absorption - Elimination des odeurs, goûts et vapeurs d'huiles	Efficacité 99,999 %	Pression P.N. 16 bar	Séparation d'huile 0,004 mg / m3
---	------------------------	-------------------------	-------------------------------------

	A	B	C	D	Débit sous 7 bar m³/h	Taraudage Gaz BSP	Référence de la cartouche de recharge	REFERENCE		
Filtration charbon actif MFC										
					Filtre et désodorise l'air comprimé Prévoir en amont un ensemble MFM - MFB Teneur en huile 0,003 ppm					
		113,6	205,5	171,4	102,0		34	G 1/4	MFCC 301	MFC 301
		113,6	205,5	171,4	102,0		59	G 3/8	MFCC 302	MFC 302
		113,6	252,0	216,4	102,0		85	G 1/2	MFCC 303	MFC 303
		132,0	262,1	219,8	127,0		127	G 3/4	MFCC 304	MFC 304
		132,0	262,1	219,8	127,0		175	G 3/4	MFCC 305	MFC 305
		200,0	326,1	238,8	127,0		267	G 1	MFCC 306	MFC 306
		200,0	336,7	276,1	178,0		437	G 1 1/2	MFCC 307	MFC 307
		200,0	433,7	373,1	178,0		612	G 1 1/2	MFCC 308	MFC 308
		200,0	566,0	505,4	178,0		681	G 2	MFCC 309	MFC 309
		230,8	634,4	550,0	204,0		993	G 2 1/2	MFCC 310	MFC 310
		230,8	634,4	550,0	204,0		1317	G 2 1/2	MFCC 311	MFC 311
		230,8	634,4	550,0	204,0		1750	G 2 1/2	MFCC 312	MFC 312
		230,8	817,1	732,7	204,0		2039	G 3	MFCC 313	MFC 313
		230,8	1085,1	1000,7	204,0		2549	G 3	MFCC 314	MFC 314

ACCESSOIRES ET PIECES DETACHEES

	DESIGNATION	REFERENCE
Jeu d'assemblage		
	Jeu d'assemblage pour filtres G 1/4 à G1/2	MPA 1
	Jeu d'assemblage pour filtres G 3/4 à G 1	MPA 2
	Jeu d'assemblage pour filtres G 1 1/2 à G 2	MPA 3
	Jeu d'assemblage pour filtres G 2 1/2 à G 3	MPA 4
	Joint pour jeu d'assemblage MPA 1	MPA J1
	Joint pour jeu d'assemblage MPA 2	MPA J2
	Joint pour jeu d'assemblage MPA J3	MPA J3
	Joint pour jeu d'assemblage MPA J4	MPA J4

ACCESSOIRES ET PIECES DETACHEES

	DESIGNATION	REFERENCE
Equerre de fixation		
	Fixation pour filtres G 1/4 à G 1/2	MPK 1
	Fixation pour filtres G 3/4 à G 1	MPK 2
	Fixation pour filtres G 1 1/2 à G 2	MPK 3
	Fixation pour filtres G 2 1/2 à G 3	MPK 4
Pièce détachée : Purge automatique à flotteur		
	Pour filtres G 1/4 à G 2	MPD
Pièces détachées : Purge automatique à sonde capacitive		
	Pour filtres G 2 1/2 à G 3	MPD X3
	Kit de maintenance pour purge à sonde capacitive	MPD X3KIT
Pièces détachées : indicateurs de colmatage		
	Pour filtres G 1/4 à G 3/4	MPI 1
	Pour filtres G 1 à G 3	MPI 2

ENSEMBLE DE FILTRATION ET REGULATION APPLICATION CARROSSERIE

Efficacité 99,999%	Equipé d'un raccord rapide	Filtration 2 étapes 1 μ - 0.01 μ	Indicateur de colmatage	Purge automatique	Utilisation peinture	Pression 2 - 12 bar
-----------------------	-------------------------------	---	-------------------------	----------------------	-------------------------	------------------------

		Débit en m3/h sous 7 bar	Pression nominale en bar	Taraudage Gaz BSP	Equipé d'un raccord	REFERENCE
Ensemble de filtration						
	<p>Ensemble monté étanche se composant de :</p> <ul style="list-style-type: none"> - 1 filtre micronique MFM - 1 μ - 1 filtre submicronique MFB - 0,01 μ - 1 régulateur avec manomètre - 2 fixations murales - 1 raccord de sécurité PREVO S1 <p>Ensemble spécial de filtration pour pistolets de peinture : peinture de qualité , élimination des cratères de silicone, microbullage et défauts résiduels.</p>	50	2 - 12	G 3/8	ISI 06	MBR 38IS
		59	2 - 12	G 3/8	ESI 07	MBR 38ES
		50	2 - 12	G 3/8	CSI 06	MBR 38CS
		50	2 - 12	G 1/2	ISI 06	MBR 12IS
		85	2 - 12	G 1/2	ESI 07	MBR 12ES
		50	2 - 12	G 1/2	CSI 06	MBR 12CS
		Ensemble de filtration pour pistolets de peinture à base aqueuse				
	<p>Ensemble monté étanche se composant de :</p> <ul style="list-style-type: none"> - 1 filtre micronique MFM - 1 μ - 1 filtre submicronique MFB - 0,01 μ - 1 filtre charbon actif MFC - Efficacité : 99.999 % - Séparation d'huile : 0.004 mg/m3 - 2 fixations murales - 1 raccord de sécurité PREVO S1 <p>Ensemble spécial de filtration pour pistolets de peinture : peinture de qualité , élimination des cratères de silicone, microbullage et défauts résiduels.</p>	50	2 - 12	G 1/2	ISI 06	MBC 12IS
		85	2 - 12	G 1/2	ESI 07	MBC 12ES
		50	2 - 12	G 1/2	CSI 06	MBC 12CS
		Ensemble de filtration et régulation pour pistolets de peinture à base aqueuse				
	<p>Ensemble monté étanche se composant de :</p> <ul style="list-style-type: none"> - 1 filtre micronique MFM - 1 μ - 1 filtre submicronique MFB - 0,01 μ - 1 filtre charbon actif MFC <p>Séparation d'huile : 0.003 mg/m3</p> <ul style="list-style-type: none"> - 1 régulateur avec manomètre - 2 fixations murales - 2 raccords rapides de sécurité PREVO S1 	59	2 - 12	G 3/8	ISI 06	MBCR 38IS
		59	2 - 12	G 3/8	ESI 07	MBCR 38ES
		59	2 - 12	G 3/8	CSI 06	MBCR 38CS
		85	2 - 12	G 1/2	ISI 06	MBCR 12IS
		85	2 - 12	G 1/2	ESI 07	MBCR 12ES
		85	2 - 12	G 1/2	CSI 06	MBCR 12CS

CARTOUCHES POUR FILTRES SUBMICRONIQUES ANCIENNES SERIES MAM - MAS - MAC

Capacité de traitement élevée		Température d'utilisation : 0 à 65°		Filtration haute efficacité	
		Débit sous 7 bar m³/h	Taraudage Gaz BSP	Référence du filtre	REFERENCE
Cartouche pour filtration de base MAM					
		30	1/4"	MAM 101	MCAM 101
		60	3/8"	MAM 102	MCAM 102
		120	1/2"	MAM 103	MCAM 103
		180	3/4"	MAM 104	MCAM 104
		300	1"	MAM 105	MCAM 105
		450	1" 1/4	MAM 106	MCAM 106
		720	1" 1/2	MAM 107	MCAM 107
		950	2"	MAM 108	MCAM 108
		1350	2"	MAM 109	MCAM 109
		1800	3"	MAM 110	MCAM 110
		2500	3"	MAM 111	MCAM 111
Cartouche pour filtration submicronique MAS					
		30	1/4"	MAS 201	MCAM 201
		60	3/8"	MAS 202	MCAM 202
		120	1/2"	MAS 203	MCAM 203
		180	3/4"	MAS 204	MCAM 204
		300	1"	MAS 205	MCAM 205
		450	1" 1/4	MAS 206	MCAM 206
		720	1"1/2	MAS 207	MCAM 207
		950	2"	MAS 208	MCAM 208
		1350	2"	MAS 209	MCAM 209
		1800	3"	MAS 210	MCAM 210
		2500	3"	MAS 211	MCAM 211
Cartouche pour filtration charbon actif MAC					
		30	1/4"	MAC 301	MCAM 301
		60	3/8"	MAC 302	MCAM 302
		120	1/2"	MAC 303	MCAM 303
		180	3/4"	MAC 304	MCAM 304
		300	1"	MAC 305	MCAM 305
		450	1" 1/4	MAC 306	MCAM 306
		720	1"1/2	MAC 307	MCAM 307
		950	2"	MAC 308	MCAM 308
		1350	2"	MAC 309	MCAM 309
		1800	3"	MAC 310	MCAM 310
		2500	3"	MAC 311	MCAM 311

CARTOUCHES POUR FILTRES SUBMICRONIQUES ANCIENNES SERIES FAM - FAS - FAC

Capacité de traitement élevée		Température d'utilisation : 0 à 65°		Filtration haute efficacité	
		Filetage du filtre	Référence du filtre	REFERENCE	
Filtration 1 micron					
		3/8"	FAM 101	FCAF 101	
		1/2"	FAM 102	FCAF 102	
		1/2"	FAM 103	FCAF 103	
		1/2"	FAM 104	FCAF 104	
		3/4"	FAM 105	FCAF 105	
		1"	FAM 106	FCAF 106	
		1"	FAM 107	FCAF 107	
		1" 1/4	FAM 108	FCAF 108	
		1" 1/4	FAM 109	FCAF 109	
		1" 1/2	FAM 110	FCAF 110	
		2"	FAM 111	FCAF 111	
		2"	FAM 112	FCAF 112	
		2"	FAM 113	FCAF 113	
		3"	FAM 114	FCAF 114	
Filtration 0,01 micron					
		3/8"	FAS 201	FCAF 201	
		1/2"	FAS 202	FCAF 202	
		1/2"	FAS 203	FCAF 203	
		1/2"	FAS 204	FCAF 204	
		3/4"	FAS 205	FCAF 205	
		1"	FAS 206	FCAF 206	
		1"	FAS 207	FCAF 207	
		1" 1/4	FAS 208	FCAF 208	
		1" 1/4	FAS 209	FCAF 209	
		1" 1/2	FAS 210	FCAF 210	
		2"	FAS 211	FCAF 211	
		2"	FAS 212	FCAF 212	
		2"	FAS 213	FCAF 213	
		3"	FAS 214	FCAF 214	
Filtration charbon actif					
		3/8"	FAC 301	FCAF 301	
		1/2"	FAC 302	FCAF 302	
		1/2"	FAC 303	FCAF 303	
		1/2"	FAC 304	FCAF 304	
		3/4"	FAC 305	FCAF 305	
		1"	FAC 306	FCAF 306	
		1"	FAC 307	FCAF 307	
		1" 1/4	FAC 308	FCAF 308	
		1" 1/4	FAC 309	FCAF 309	
		1" 1/2	FAC 310	FCAF 310	
		2"	FAC 311	FCAF 311	
		2"	FAC 312	FCAF 312	

CARTOUCHES COMPATIBLES POUR FILTRES SUBMICRONIQUES

		Filetage	Référence du filtre Prevost	Compatible Zander	Compatible Creyssensac	REFERENCE
Filtration 3 micron - Grade V (bleu)						
		1/4"	Micro F13V	1/1050V	213061-13	MCAF 13V
		3/8"	Micro F17V	1/1070V	213062-13	MCAF 17V
		1/2"	Micro F21V	1/1140V	213063-13	MCAF 21V
		3/4"	Micro F27V	1/2010V	213064-13	MCAF 27V
		1"	Micro F34V	1/2020V	213065-13	MCAF 34V
		1" 1/2	Micro F491V	1/2030V	213046-13	MCAF 491V
		1" 1/2	Micro F492V	1/2050V	213066-13	MCAF 492V
		2"	Micro F601V	1/3050V	213067-13	MCAF 601V
		2"	Micro F602V	1/3075V	213068-13	MCAF 602V
	DN 80	Micro F90V	1/5075V		MCAF 90V	
Filtration 1 micron - Grade Z (vert)						
		1/4"	Micro F13Z	1/1050Z	213069-13	MCAF 13Z
		3/8"	Micro F17Z	1/1070Z	213070-13	MCAF 17Z
		1/2"	Micro F21Z	1/1140Z	213071-13	MCAF 21Z
		3/4"	Micro F27Z	1/2010Z	213072-13 / 213225-13	MCAF 27Z
		1"	Micro F34Z	1/2020Z	213073-13 / 213226-13	MCAF 34Z
		1" 1/2	Micro F491Z	1/2030Z	213074-13 / 213227-13	MCAF 491Z
		1" 1/2	Micro F492Z	1/2050Z	213048-13	MCAF 492Z
		2"	Micro F601Z	1/3050Z	213075-13 / 213229-13	MCAF 601Z
		2"	Micro F602Z	1/3075Z	213076-13	MCAF 602Z
	DN 80	Micro F90Z	1/5075Z		MCAF 90Z	
Filtration 0,01 micron - Grade X (rouge)						
		1/4"	Micro F13X	1/1050X	213077-13	MCAF 13X
		3/8"	Micro F17X	1/1070X	213078-13	MCAF 17X
		1/2"	Micro F21X	1/1140X	213079-13	MCAF 21X
		3/4"	Micro F27X	1/2010X	213080-13 / 213240-13	MCAF 27X
		1"	Micro F34X	1/2020X	213081-13	MCAF 34X
		1" 1/2	Micro F491X	1/2030X	213047-13	MCAF 491X
		1" 1/2	Micro F492X	1/2050X	213049-13 / 213243-13	MCAF 492X
		2"	Micro F601X	1/3050X	213082-13 / 213244-13	MCAF 601X
		2"	Micro F602X	1/3075X	213083-13	MCAF 602X
	DN 80	Micro F90X	1/5075X		MCAF 90X	
Charbon actif - Grade A						
		1/4"	Micro SA1	1/1050A	213084-13	MCAF SA1
		3/8"	Micro SA2	1/1070A	213085-13	MCAF SA2
		1/2"	Micro SA4	1/1140A	213086-13	MCAF SA4
		3/4"	Micro SA6	1/2010A	213087-13	MCAF SA6
		1"	Micro SA8	1/2020A	213088-13 / 213256-13	MCAF SA8
		1" 1/2	Micro SA10	1/2030A	213089-13	MCAF SA10
		1" 1/2	Micro SA15	1/2050A	213090-13	MCAF SA15
		2"	Micro SA16	1/3050A	213091-13	MCAF SA16
		2"	Micro SA18	1/3075A	213092-13	MCAF SA18

CARTOUCHES COMPATIBLES POUR FILTRES SUBMICRONIQUES

		Compatible Deltach	Compatible Creyssensac	Filetage du filtre	Référence du filtre	REFERENCE
Série PFD - Filtration 1 micron (bleu)						
		850 PFD	113-471-13	1/4"	MCM 101	MCAF 101
		851 PFD	113-472-13	1/2"	MCM 102	MCAF 102
		852 PFD	113-473-13	1/2"	MCM 103	MCAF 103
		870 PFD	113-474-13	3/4"	MCM 104	MCAF 104
		871 PFD	113-475-13	1"	MCM 105	MCAF 105
		872 PFD	113-476-13	1"	MCM 106	MCAF 106
		8101 PFD	113-477-13	1"	MCM 107	MCAF 107
		8102 PFD	113-478-13	2"	MCM 108	MCAF 108
		8111 PFD	113-480-13	2"	MCM 109	MCAF 109
		8113 PFD	113-479-13	2"	MCM 110	MCAF 110
Série CFD - Charbon actif						
		850 CFD	113-462-13	1/4"	MCC 301	MCAF 301
		853 CFD	113-463-13	1/2"	MCC 302	MCAF 302
		854 CFD	113-464-13	1/2"	MCC 303	MCAF 303
		873 CFD	113-465-13	3/4"	MCC 304	MCAF 304
		874 CFD	113-466-13	1"	MCC 305	MCAF 305
		875 CFD	113-467-13	1"	MCC 306	MCAF 306
		8105 CFD	113-468-13	1" 1/2	MCC 307	MCAF 307
		8112 CFD	113-469-13	2"	MCC 308	MCAF 308
		8121 CFD	113-470-13	2"	MCC 309	MCAF 309
Série HFD - Filtration 0,01 micron (rouge)						
		850 HFD	113-481-13	1/4"	MCS 201	MCAF 201
		851 HFD	113-482-13	1/2"	MCS 202	MCAF 202
		852 HFD	113-483-13	1/2"	MCS 203	MCAF 203
		870 HFD	113-484-13	3/4"	MCS 204	MCAF 204
		871 HFD	113-485-13	1"	MCS 205	MCAF 205
		872 HFD	113-486-13	1"	MCS 206	MCAF 206
		8101 HFD	113-487-13	1" 1/2	MCS 207	MCAF 207
		8102 HFD	113-488-13	2"	MCS 208	MCAF 208
		8111 HFD	113-490-13	2"	MCS 209	MCAF 209
		8113 HFD	113-489-13	2"	MCS 210	MCAF 210

CARTOUCHES COMPATIBLES POUR FILTRES SUBMICRONIQUES

		Compatible Ultrafilter	REFERENCE
Série 90 - Filtration 0,03 mg/m3 - Type MF (bleu)			
		MF 02/05	MUF 0205
		MF 03/05	MUF 0305
		MF 03/10	MUF 0310
		MF 04/10	MUF 0410
		MF 04/20	MUF 0420
		MF 05/20	MUF 0520
		MF 05/25	MUF 0525
		MF 07/25	MUF 0725
		MF 07/30	MUF 0730
		MF 10/30	MUF 1030
		MF 15/30	MUF 1530
		MF 20/30	MUF 2030
		MF 30/30	MUF 3030
	MF 30/50	MUF 3050	
Série 90 - Filtration 0,01 mg/m3 - Type SMF (rouge)			
		SMF 02/05	MUS 0205
		SMF 03/05	MUS 0305
		SMF 03/10	MUS 0310
		SMF 04/10	MUS 0410
		SMF 04/20	MUS 0420
		SMF 05/20	MUS 0520
		SMF 05/25	MUS 0525
		SMF 07/25	MUS 0725
		SMF 07/30	MUS 0730
		SMF 10/30	MUS 1030
		SMF 15/30	MUS 1530
		SMF 20/30	MUS 2030
		SMF 30/30	MUS 3030
	SMF 30/50	MUS 3050	
Série 90 - Charbon actif - 0,003 ppm - Type AK			
		AK 02/05	MUC 0205
		AK 03/05	MUC 0305
		AK 03/10	MUC 0310
		AK 04/10	MUC 0410
		AK 04/20	MUC 0420
		AK 05/20	MUC 0520
		AK 05/25	MUC 0525
		AK 07/25	MUC 0725
		AK 07/30	MUC 0730
		AK 10/30	MUC 1030
		AK 15/30	MUC 1530
		AK 20/30	MUC 2030
		AK 30/30	MUC 3030
	AK 30/50	MUC 3050	

CARTOUCHES COMPATIBLES POUR FILTRES SUBMICRONIQUES

		Compatible Domnick Hunter	REFERENCE
Série K - Filtration 1 micron - Grade AO (vert)			
		K 009 AO	MDO 009
		K 017 AO	MDO 017
		K 030 AO	MDO 030
		K 058 AO	MDO 058
		K 145 AO	MDO 145
		K 220 AO	MDO 220
		K 330 AO	MDO 330
		K 430 AO	MDO 430
		K 620 AO	MDO 620
Série K - Filtration 0,01 micron - 0,01 mg/m3 - Grade AA (bleu)			
		K 009 AA	MDA 009
		K 030 AA	MDA 030
		K 058 AA	MDA 058
		K 145 AA	MDA 145
		K 220 AA	MDA 220
		K 330 AA	MDA 330
		K 430 AA	MDA 430
		K 620 AA	MDA 620
Série K - Charbon actif - Grade ACS			
		K 009 ACS	MDS 009
		K 017 ACS	MDS 017
		K 030 ACS	MDS 030
		K 058 ACS	MDS 058
		K 145 ACS	MDS 145
		K 220 ACS	MDS 220
		K 330 ACS	MDS 330
		K 430 ACS	MDS 430
		K 620 ACS	MDS 620

CARTOUCHES COMPATIBLES POUR FILTRES SUBMICRONIQUES

		Compatible Hiross	REFERENCE
Filtration 1 micron - Grade P (bleu)			
		P 004	MHP 004
		P 007	MHP 007
		P 015	MHP 015
		P 024	MHP 024
		P 035	MHP 035
		P 060	MHP 060
		P 090	MHP 090
		P 120	MHP 120
		P 150	MHP 150
		P 240	MHP 240
	P 260	MHP 260	
Filtration 0,01 micron - Grade S (rouge)			
		S 007	MHS 007
		S 015	MHS 015
		S 024	MHS 024
		S 035	MHS 035
		S 060	MHS 060
		S 090	MHS 090
		S 120	MHS 120
		S 150	MHS 150
		S 240	MHS 240
		S 260	MHS 260
Charbon actif - Grade C			
		C 004	MHC 004
		C 007	MHC 007
		C 015	MHC 015
		C 024	MHC 024
		C 035	MHC 035
		C 060	MHC 060
		C 090	MHC 090
		C 120	MHC 120
		C 150	MHC 150
		C 240	MHC 240
	C 260	MHC 260	

purgeurs

SÉPARATEURS, PURGEURS ET UNITÉS DE RETRAITEMENT

EAU, HUILE, POLLUANTS : SÉPARATION ET ÉVACUATION

Les condensats collectés par filtration ou séparation le long du réseau d'air, sont à évacuer rapidement et efficacement pour ne pas polluer le circuit et nuire aux organes pneumatiques.

Séparateurs, purgeurs et unités de traitement apportent des solutions efficaces pour l'évacuation et le traitement des rejets.

Le choix du type de purge à utiliser se fera en fonction de l'importance du réseau, des emplacements à équiper, de l'accessibilité de la ligne d'air.

L'installation de purgeurs est le complément indispensable à une bonne filtration de l'air comprimé.

Un réseau correctement équipé assure l'efficacité des outils pneumatiques et la qualité du travail effectué.



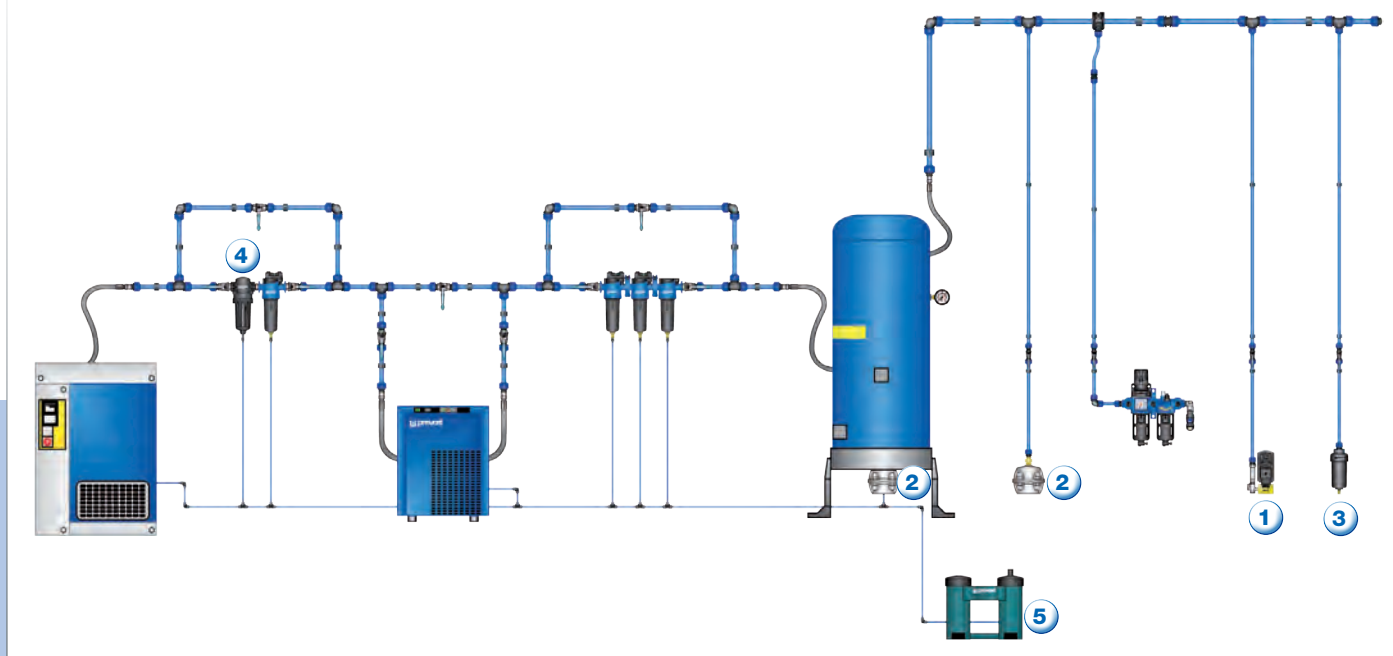







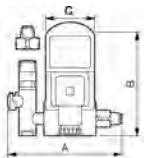

MODÈLE	EMPLACEMENT	FONCTIONNEMENT	AVANTAGES
1 PURGES ÉLECTRIQUES TEMPORISÉES	Points bas, cuve de compresseurs, sècheurs, séparateurs, filtre.	Équipées d'un temporisateur et d'une électro-vanne, les purges électriques temporisées s'ouvrent en fonction d'une minuterie (réglable par l'utilisateur) et évacuent les polluants accumulés.	<ul style="list-style-type: none"> - En fonction de la pollution et de l'humidité dans les canalisations : - choix de la durée d'ouverture de purge. - choix de la fréquence d'ouverture de purge. - Ensemble compact. - Intégrable en toutes positions sur tous les points d'utilisation.
2 PURGE MAGNÉTIQUE	Points bas, cuves de tous types de filtres.	L'évacuation des condensats est automatique grâce une vanne magnétique. A un certain niveau d'eau, le flotteur ouvre la vanne magnétique. L'eau évacuée, le flotteur redescend et ferme la vanne.	<ul style="list-style-type: none"> - Aucune perte d'air comprimé. - Pas d'alimentation électrique. - Pas de réglage. - Entretien par simple nettoyage. - Capacité d'évacuation importante. - Corps en aluminium résistant à la corrosion. - Pas de risques d'émulsion des condensats.
3 PURGES MÉCANIQUES À FLOTTEUR	Points bas, bouts de lignes.	En fonction du niveau d'eau dans le bol de purge, le flotteur se soulève et libère l'ouverture du bol. Dès l'évacuation des condensats, le flotteur s'abaisse fermant l'orifice.	<ul style="list-style-type: none"> - Purge automatique et autonome. - Pas de perte d'air comprimé. - Évacuation d'eau chargée en émulsion (huile). - Construction robuste.
4 SÉPARATEUR À PURGE AUTOMATIQUE	Sortie de compresseur, sortie de cuve, pré-filtre pour sècheurs par réfrigération ou filtres sub-microniques.	Le séparateur a une double fonction : - l'air qui entre dans le séparateur est entraîné dans un système cyclonique à ailettes qui sépare eau, huile et particules solides, - les condensats sont ensuite éliminés par une purge à flotteur.	<ul style="list-style-type: none"> - Double action : séparation et évacuation. - Possibilité de température élevée en entrée. - Construction robuste. - Avantage de la purge à flotteur. - Fonctionnement économique et fiable.
5 UNITÉ DE RETRAITEMENT DES CONDENSATS	Collecte de tous les rejets de l'installation.	Les rejets provenant de compresseurs lubrifiés sont nuisibles à notre environnement. La collecte des polluants et leur traitement direct, avec une unité de traitement, permet de concentrer et de récupérer l'huile en très faible quantité.	<ul style="list-style-type: none"> - Solution économique pour le traitement des rejets et la préservation de notre environnement. - Réduction des coûts par la simplicité de fonctionnement. - Amortissement rapide. - Facilité de montage et de mise en oeuvre. - Aucune source spéciale d'alimentation.

PURGES ELECTRIQUES TEMPORISEES

Fréquence d'ouverture 0.5 - 45 min	Durée d'ouverture 0.5 - 10 sec	Alimen- tation 24 - 220V 50 Hz	Passage 4.5 mm	Purge toutes positions Eau, huile, condensats	1 voie normalement fermée	Pression 0 - 16 bar	Température +2°C - +65°C	Connexion ISO 4400	Protection IP 65
---------------------------------------	-----------------------------------	--------------------------------------	-------------------	---	---------------------------------	------------------------	-----------------------------	-----------------------	---------------------

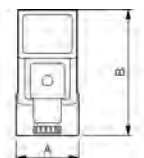
		A	B	C	DESIGNATION	REFERENCE
Kit de purge temporisée						
					Kit prêt à monter comprenant: - un timer programmable - une électrovanne d'évacuation de condensats 220 V - un collecteur d'impureté avec vanne d'isolement 1/4 de tour - une alimentation électrique complète longueur : 1,20 m - un raccord autobloquant : Ø 8 mm - 30 cm de tube polyuréthane : Ø 8 mm	
		98	115	43	Entrée G 3/8 ou G 1/2 - Sortie G 3/8	TEMP 38220KIT
Purge temporisée complète						
					Kit comprenant : - un timer programmable - une électrovanne d'évacuation de condensats 220 V - un collecteur d'impureté avec vanne d'isolement 1/4 de tour	
		80	115	43	Entrée G 1/2 - Sortie G 3/8	TEMP 38220COL
Purge temporisée (timer électrovanne)						
		43	115		Orifices G 1/8 - 220 V	TEMP 18220V
		43	115		Orifices G 1/4 - 220 V	TEMP 14220V
		43	115		Orifices G 3/8 - 220 V	TEMP 38220V
		43	115		Orifices G 1/2 - 220 V	TEMP 12220V
Purge temporisée complète série ECONOMIQUE						
					Kit comprenant : - un timer programmable - une électrovanne d'évacuation de condensats 220 V - un collecteur d'impureté avec vanne d'isolement 1/4 de tour	
		77	100		Entrée G 1/2 - Sortie G 3/8	TEMP 38220COLSE
Purge temporisée série ECONOMIQUE						
					Monotension : 220 V Passage : 4 mm Pression : 0 à 16 bar Taraudage :	
		40	100		G 1/4	TEMP 14220SE
		40	100		G 3/8	TEMP 38220SE



PURGES ELECTRIQUES TEMPORISEES

Fréquence d'ouverture 0.5 - 45 min	Durée d'ouverture 0.5 - 10 sec	Alimen- tation 24 - 220V 50 Hz	Passage 4.5 mm	Purge toutes positions Eau, huile, condensats	1 voie normalement fermée	Pression 0 - 16 bar	Température +2°C - +65°C	Connexion ISO 4400	Protection IP 65
---------------------------------------	-----------------------------------	--------------------------------------	-------------------	---	---------------------------------	------------------------	-----------------------------	-----------------------	---------------------

		A	B	C	DESIGNATION	REFERENCE
Mini purge temporisée pour cuve de filtre						
		38	80		Taraudage : G 1/8 Temps d'ouverture : 2 sec Fréquence : 1 à 120 min Tension : 220 V Contrôle d'ouverture par test manuel	TEMP MN220V
					Adaptateur pour montage sur cuve de filtre G 1/8	FAP 18
Purge temporisée HAUTE PRESSION						
		43	115		Pression : 0 à 40 bar Taraudage : G 1/4 Tension : 220 V Pression de 0 à 40 bar Ø de passage : 2 mm	TEMP 14220HP
Purge temporisée QUALITE ALIMENTAIRE						
					Electrovanne en acier inox Tension : 220 V Pression de 0 à 16 bar Electrovanne en acier inoxydable 304 Ø de passage : 4,5 mm	
		43	115		G 1/4	TEMP 14220INOX
Pièces détachées pour purges temporisées						
		43	115		1.Timer seul 24 à 240 volt alternatif ou continu	TEMP
		41	53		2.Bobine 50 Hz alternatif Voltage standard 24 V	BOB 24VA
		41	53		Voltage standard 48 V	BOB 48VA
		41	53		Voltage standard 110 V	BOB 110VA
		41	53		Voltage standard 220 V	BOB 220VA
		74	40		3.Electrovanne G 1/8	ELV 18
		74	40		Electrovanne G 1/4	ELV 14
		74	40		Electrovanne G 3/8	ELV 38
		74	40		Electrovanne G 1/2	ELV 12
		74	40		Electrovanne Haute pression 0 à 40 bar G 1/4	ELV 14HP
		74	40		Electrovanne inox 304 G 1/4	ELV 14INOX
		77	48		4. Collecteur d'impuretés avec vanne d'isolement Entrée G 1/2 mâle Sortie G 3/8 mâle	COL 1238



PURGES ELECTRIQUES TEMPORISEES

Fréquence d'ouverture 0.5 - 45 min	Durée d'ouverture 0.5 - 10 sec	Alimen- tation 24 - 220V 50 Hz	Passage 4.5 mm	Purge toutes positions Eau, huile, condensats	1 voie normalement fermée	Pression 0 - 16 bar	Température +2°C - +65°C	Connexion ISO 4400	Protection IP 65
---------------------------------------	-----------------------------------	--------------------------------------	-------------------	---	---------------------------------	------------------------	-----------------------------	-----------------------	---------------------

		A	B	C	DESIGNATION	REFERENCE
Pièces détachées pour purges série ECONOMIQUE						
		43	74		Timer seul	TEMP SE
		63	35		Electrovanne avec bobine 220 V : G 1/4	ELV 14SE
		68	40		G 3/8	ELV 38SE

SEPARATEURS D'EAU

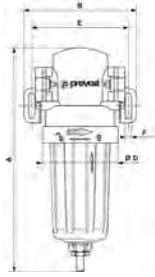
Entretien réduit	Evacuation Eau, huile, condensats	Sortie de purge Cannelure 8 mm	Matière Aluminium anodisé	Pression 1 à 16 bar	Température 1° C à 65° C	Purge automatique à flotteur	Post filtre pour compresseur
------------------	---	-----------------------------------	------------------------------	------------------------	-----------------------------	---------------------------------	---------------------------------

		A	B	C	D	Débit Mini en m³/h - DP = 1%	Poids du séparateur	Taraudage Gaz BSP	Débit Maxi en m³/h - DP = 1%	REFERENCE
Séparateur d'eau cyclonique à purge à flotteur										
		258.50	103	219	24.5	60	1.4	G 1/2	144	SPC 120
		344	139	297.50	24.5	105	2.5	G 3/4	252	SPC 210
		344	139	297.5	24.5	160	2.5	G 1	384	SPC 320
		548	190	485	24.5	225	2.7	G 1 1/2	540	SPC 450
		548	190	485	24.5	375	2.7	G 2	900	SPC 750
		626	190	563	103	550	2.7	G 2	1 320	SPC 1101
Purge pour séparateur SPC										
										SPC D1275
Fixation murale pour SPC										
										SPC K120 SPC K210 SPC K450

PURGES MECANIQUES

Entretien réduit	Entrée taraudée	Evacuation Eau, huile, condensats			Point bas Bouts de ligne	Purge automatique à flotteur
Purge d'évacuation d'eau automatique à flotteur		A	B	C	DESIGNATION	REFERENCE
		133	53	28	Purge automatique à flotteur Raccordement entrée : G 1/2 Sortie de purge : Ø 8 mm Poids du purgeur : 422 g Pression : 2 à 12 bar Température maxi : 80° C	PAM 21
Pièces détachées pour PAM 21					Flotteur pour purgeur PAM 21	PAM FLO
		216	116		Attention : le polycarbonate est incompatible avec les diluants et certaines huiles chargées d'esters Raccordement entrée : G 1/2 Sortie de purge : G 1/8 Débit de purge à 7 bar : 560 l/heure Poids du purgeur : 1960 g Pression : 10 bar à 20° C Temperature : 2° à 55° C	PEA 21
Purge manuelle						
		23	15		Purge manuelle G 1/8	MA 18
		23	15		Purge manuelle G 1/4	MA 14
		26	17		Purge manuelle G 3/8	MA 38

PURGE MAGNETIQUE

Matière Corps Aluminium - Joint Viton	Sortie de purge 2 mm	Température + 2° C à 50° C	Purge automatique	Entretien réduit	Entrée taraudée 2 x G 1/2	Point bas	Pression 16 bar
---	-------------------------	-------------------------------	-------------------	------------------	------------------------------	-----------	--------------------

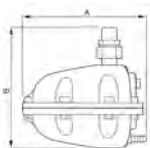
		A	B	DESIGNATION	REFERENCE
Purge magnétique d'évacuation des condensats					
				Aucune perte d'air comprimé pendant l'évacuation des condensats. Purge autonome ne nécessitant pas d'alimentation électrique. Mécanisme simple et fiable par commande magnétique. Capacité importante d'évacuation. Installation simple et rapide Corps en aluminium résistant à la corrosion	
		140	165	Evacuation des condensats : 200 l/heure 2 connexions entrée : G 1/2 femelle Sortie : G 1/8 femelle Valve magnétique	PMA 200

SEPARATEURS DE CONDENSATS

Protection environnement	Amortissement rapide	Matière PE	Efficacité
--------------------------	----------------------	---------------	------------

		Référence de la cartouche de rechange Pré-filtre	Référence de la cartouche de rechange charbon actif	Capacité de traitement m3/h	Degré de séparation	Entrée des condensats	Sortie eau	REFERENCE
Séparateurs huile et eau								
	Modèles SPH 110, SPH 480, SPH 2100 et SPH EXT : - Ne nécessite pas de purge à sonde capacitive en amont - Séparateur pouvant recevoir des émulsions stables - Accepte des huiles minérales et synthétiques							
	SPH 210CAFW	SPH 210CAFB	0 à 108 m3/h	< 10 ppm	G 1/2	G 1/2	SPH 210	
	SPH 480CAFW	SPH 480CAFB	0 à 480	< 10 ppm	2 x G 1/2	G 1/2	SPH 480	
	SPH 2100CAFW	SPH 2100CAFB	0 à 2100	< 10 ppm	4 x G 1/2	3 x G 1/2	SPH 2100	
	Extension pour SPH 2100	SPH EXTCAFB	2100 à 4200	< 10 ppm			SPH EXT	

SEPARATEURS DE CONDENSATS

KITS DE MAINTENANCE

Protection environnement	Amortissement rapide	Matière PE	Efficacité
--------------------------	----------------------	------------	------------

		DESIGNATION	REFERENCE
Kits de maintenance pour unités de traitement			
		Cartouche de dessicant pour SPH 210	SPH 210CAFW
		Cartouche de charbon actif pour SPH 210	SPH 210CAFB
		Cartouche de dessicant pour SPH 480	SPH 480CAFW
		Cartouche charbon actif pour SPH 480	SPH 480CAFB
		Cartouche de dessicant pour SPH 2100	SPH 2100CAFW
		Cartouche charbon actif pour SPH 2100	SPH 2100CAFB
		Cartouche charbon actif pour SPH EXT	SPH EXTCAFB

sécheurs

SÉCHEURS PAR RÉFRIGÉRATION **ALTITUDE**

EFFICACITÉ, SÛRETÉ ET SIMPLICITÉ

En sortie de compresseur, l'air comprimé contient de l'eau (gouttelettes ou vapeur) nuisible au fonctionnement des machines et outils pneumatiques. Pour assurer un travail de qualité, il faut éliminer l'eau de l'air : c'est le rôle du sécheur d'air.

En abaissant la température de l'air comprimé par un échange thermique, le sécheur provoque la condensation de l'eau contenue dans l'air.

L'eau condensée est ensuite éliminée par une purge intégrée au sécheur.



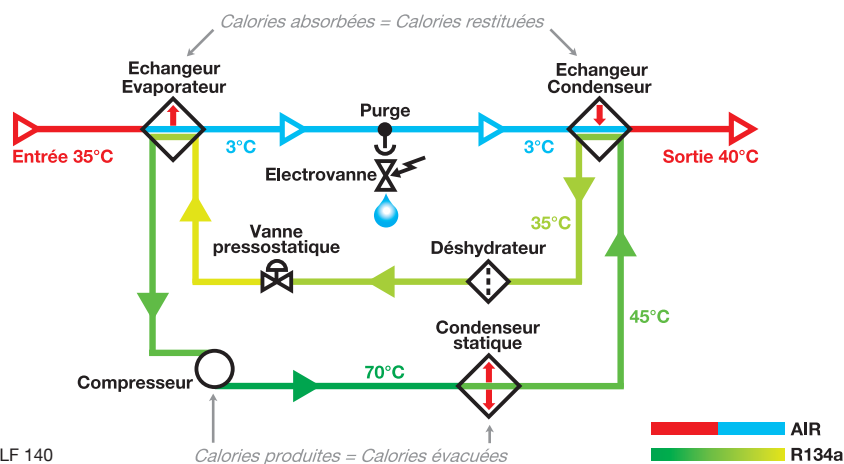

*schéma pour les références ALF 30 à ALF 140

TECHNOLOGIE UNIQUE

**Les sècheurs ALF :
une technologie unique (ALF 30 à ALF 820)**

► Un circuit frigorifique original à double condenseurs

- sans ventilateur
- sans pressostat de ventilateur
- à faible consommation d'énergie

► Un fonctionnement sûr et simple identique à celui d'un réfrigérateur domestique

- assurant un point de rosée à 3°C stable en toutes conditions
- à toutes les températures ambiantes de 4.4°C à + 43°C sans facteur de correction de débit
- sans risque de gel
- insensible à la poussière
- silencieux et propre
- avec de faibles pertes de charge

AVANTAGES

- Sècheurs équipés de 2 condenseurs pour le réfrigérant
 - 1 condenseur extérieur statique : R134a/Air ambiant
 - 1 condenseur extérieur statique : réfrigérant/air ambiant
- Transfert d'énergie équilibré entre l'évaporateur et le condenseur air comprimé/réfrigérant assurant la stabilité du point de rosée
- Température de sortie de l'air comprimé supérieure de 5°C par rapport à la température d'entrée.
- Réfrigérant :
 - R134a du modèle ALF 30 à ALF 161
 - R407c du modèle ALF 240 à ALF 820

FACTEUR DE CORRECTION F1 selon température entrée et pression

Pression en bar	Température			
	35°C	40°C	45°C	50°C
3	0,79	0,63	0,51	0,43
4	0,87	0,72	0,60	0,52
5	0,92	0,77	0,65	0,56
6	0,96	0,81	0,68	0,60
7	1,00	0,84	0,71	0,63
8	1,03	0,87	0,74	0,65
9	1,07	0,91	0,78	0,67
10	1,10	0,93	0,80	0,70
11	1,13	0,96	0,82	0,73
12	1,16	0,98	0,84	0,75
13	1,18	1,00	0,86	0,77
14	1,21	1,02	0,88	0,80

CONDITIONS DE FONCTIONNEMENT

Point de rosée :+ 3°C
 Classification protection : IP 23
 Alimentation électrique : 230V 50 Hz
 Purge des condensats : électrovanne temporisée
 Pression mini : 2 bar
 Pression de service : 7 bar
 Pression maxi : 16 bar
 Température d'entrée de l'air comprimé : mini 4°C
 Température d'entrée de l'air comprimé : maxi 49°C
 Garantie 2 ans.
 Échange standard sous réserve d'un diagnostic réalisé par Prevost

UTILISATION DES FACTEURS DE CORRECTION





Exemple :
 Sélection d'un sécheur pour
 Débit (V1) 75 m³/h
 Pression 10 bar
 Température entrée 45°C
 Débit équivalent V2
 Facteur de correction F1 selon température entrée et pression : 0,80

$$V2 = \frac{V1}{F1} \quad \text{Soit } V2 = \frac{75}{0,8} = 94 \text{ m}^3/\text{h}$$

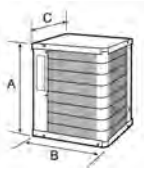

Nous sélectionnons le modèle **ALF 100**

SECHEURS PAR REFRIGERATION ALTITUDE

Alimen- tation 230 V 50 Hz	Protection IP 23	Température ambiante maxi : + 43° C	Température ambiante mini : + 4,4 ° C	Pression maxi: 16 bar	Point de rosée + 3° C
-------------------------------	---------------------	--	--	--------------------------	--------------------------

		A	B	C	Filetage mâle	Sécheur pour compresseur de (CV) :	Débit Nm ³ /h	Niveau sonore dB (A)	Consom- mation kW	Poids kg	REFERENCE	
Sécheurs Altitude												
	<p>Simplicité de conception Evacuation des condensats par purge temporisée Garantie 2 ans (échange standard, sous réserve diagnostic réalisé par PrevoSt) Réfrigérant : - ALF 30 à ALF 161 : R134a - ALF 240 à ALF 820 : R407c Pression d'entrée : 7 bar Température d'entrée : 35°C Température ambiante : 25°C selon norme ISO 7183</p>											
												
												

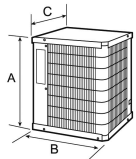
SECHEURS PAR REFRIGERATION AVEC EQUIPEMENT DE CONNEXION ET FILTRATION

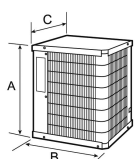
Protection IP 23	Pression maxi : 16 bar	Température ambiante maxi : + 43°C	Alimen- tation 230 V 50 Hz	Température ambiante mini : + 4,4 °C	Point de rosée + 3° C			
		Débit m ³ /h	Niveau sonore dB	Sécheur pour compresseur de (CV) : CV	Consom- mation kW	Sortie du filtre ou du by-pass	Entrée du By-pass	REFERENCE
Sécheur par réfrigération équipé d'un ensemble by-pass, flexibles de liaison et filtre micronique								
		30	45	4	0,24	G 3/8 F.	R 1/2 M.	ALF LM30
		60	51	7,5	0,41	G 1/2 F.	R 3/4 M.	ALF LM60
		80	53	10	0,46	G 1/2 F.	R 3/4 M.	ALF LM80
		100	53	15	0,57	G 3/4 F.	R 3/4 M.	ALF LM100
		140	60	20	0,58	G 3/4 F.	G 1 F.	ALF LM140
Sécheur par réfrigération équipé d'un ensemble by-pass et flexibles de liaison								
		30	45	4	0,24	R 1/2 M.	R 1/2 M.	ALF L30
		60	51	7,5	0,41	R 3/4 M.	R 3/4 M.	ALF L60
		80	53	10	0,46	R 3/4 M.	R 3/4 M.	ALF L80
		100	53	15	0,57	R 3/4 M.	R 3/4 M.	ALF L100
		140	20	60	0,58	G 1 F.	G 1 F.	ALF L140

ENSEMBLE BY-PASS

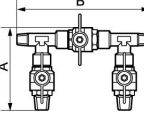
Matière Laiton	Montage simple	Filetage Gaz BSP	Vannes 1/4 de tour		
		A	B	DESIGNATION	REFERENCE
Ensemble by-pass pour installation de sécheur					
		108	165	G 1/2 mâle	MBP 21
		120	190	G 3/4 mâle	MBP 27
		135	240	G 1 femelle	MBP 34

Raccordement tournant	Matière Caoutchouc synthétique, tresse acier	Norme ISO 4413 - 1998	Résistance huiles, abrasion, ozone
-----------------------	---	--------------------------	---------------------------------------

		Longueur m.	Température °C	Pression maxi. de service (bar)	Filetage Gaz BSP	Rayon de courbure à 20°C (mm)	REFERENCE
Flexibles de compensation des dilations et contractions des réseaux d'air - Raccordements mâles tournants							
	NOUVEAU	0.75	-40° +70° C	105	R 3/4	240	LAM 27
		0.75	-40° +70° C	88	R 1	300	LAM 34
		1.1	-40° +70° C	63	R 1 1/4	420	LAM 42
		1.25	-40° +70° C	50	R 1 1/2	500	LAM 49
		1	-40° +70° C	40	R 2	630	LAM 60
Flexible de liaison - Raccordements femelles tournants							
	NOUVEAU	1.5	-40° +110° C	180	G 3/8	130	LEF 17
		1.5	-40° +110° C	160	G 1/2	130	LEF 21
		1.5	-40° +110° C	105	G 3/4	240	LEF 27
		1.5	-40° +110° C	88	G 1	300	LEF 34
		2.2	-40° +110° C	63	G 1 1/4	420	LEF 42
		2.5	-40° +110° C	50	G 1 1/2	500	LEF 49
		2	-40° +110° C	80	G 2	630	LEF 60
Flexibles de liaison avec câble acier de sécurité - Raccordements femelles tournants							
	NOUVEAU	1.5	-40° + 110°C	180	G 3/8	130	LEF 17S
		1.5	-40° +110° C	160	G 1/2	130	LEF 21S
		1.5	-40° +110° C	105	G 3/4	240	LEF 27S
		1.5	-40° +110° C	88	G 1	300	LEF 34S
Flexibles de liaison - Raccordement mâles tournants							
	NOUVEAU	1.5	-40° +110° C	180	R 3/8	130	LEM 17
		1.5	-40° +110° C	160	R 1/2	180	LEM 21
		1.5	-40° +110° C	105	R 3/4	240	LEM 27
		1.5	-40° +110° C	80	R 1	300	LEM 34
		2.2	-40° +110° C	63	R 1 1/4	420	LEM 42
		2.5	-40° +110° C	50	R 1 1/2	500	LEM 49
		2	-40° +110° C	80	R 2	630	LEM 60
Flexibles de liaison avec câble de sécurité - Raccordements mâles tournants							
	NOUVEAU	1.5	-40° +110° C	180	R 3/8	130	LEM 17S
		1.5	-40° +110° C	160	R 1/2	180	LEM 21S
		1.5	-40° +110° C	105	R 3/4	240	LEM 27S
		1.5	-40° +110° C	88	R 3/4	300	LEM 34S

sécheurs

SÉCHEURS PAR ADSORPTION **ALASKA**

POUR TOUTES LES APPLICATIONS QUI DEMANDENT UN AIR PARFAITEMENT SEC :

- air de qualité pour laboratoires, industrie agro-alimentaire, robotique, télécommunications, laser
- instrumentation et régulation électronique
- installations d'air comprimé soumises à des températures inférieures à + 3°C
- scieries, centrales à béton, carrières, industries chimiques et pharmaceutiques

Le sécheur par adsorption **ALC** apporte un fonctionnement continu à haut rendement. Équipé en standard d'une filtration amont et aval avec purge automatique, il fournit un air sec et dépoussiéré.



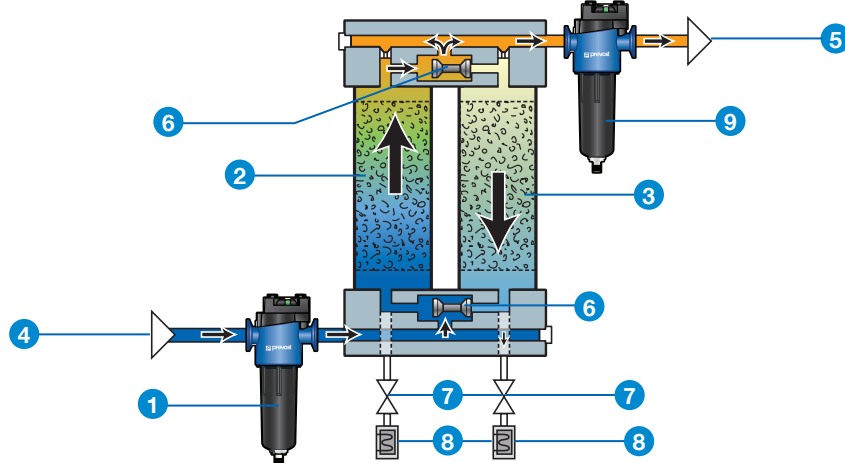

- 1 Filtre submicronique
- 2 Cuve d'adsorption gauche
- 3 Cuve d'adsorption droit
- 4 Air humide entrant
- 5 Air sec sortant
- 6 Vanne bidirectionnelle
- 7 Électro-vanne
- 8 Silencieux d'échappement
- 9 Filtre micronique

PRÉSENTATION

Le sécheur est constitué de deux colonnes de lit de dessiccant. Lorsque la première est en phase de séchage, la seconde est en phase de régénération.

L'air comprimé humide en entrée est dirigé par une vanne bidirectionnelle au bas d'une des colonnes.

La phase de séchage s'effectue du bas vers le haut, puis l'air est dirigé vers la seconde vanne bidirectionnelle; celle-ci dérive une faible partie de l'air déshydraté de façon à éliminer, à pression atmosphérique, l'humidité contenue dans l'autre colonne.*

La dépressurisation progressive et régulière est assurée par les silencieux positionnés sous le sécheur évitant ainsi toute pollution atmosphérique et limitant le niveau sonore d'échappement.

**L'air utilisé par la colonne en phase de régénération représente environ 15% du débit d'entrée du sécheur (ce "débit de régénération" est considéré lors du choix du modèle de sécheur à installer).*

AVANTAGES

► Avantages sécheurs ALC :

- Fiabilité de fonctionnement continu à la capacité maximale
- Indicateur de saturation du dessiccant par changement de couleur permettant le contrôle du point de rosée
- Faible perte de charge
- Pression de sortie constante et longévité du dessiccant maintenues par une pressurisation régulière et progressive des colonnes
- Carrosserie acier compacte et solide avec revêtement epoxy
- Niveau sonore < 78 dB(A) grâce à l'emploi de silencieux de qualité
- Filtration amont: 0,01 micron par filtre submicronique, filtration aval: 1 micron
- Simplicité et faible coût de maintenance. Remplacement rapide et propre des cartouches de dessiccant.

TENSION D'ALIMENTATION 230 V - 50 Hz

Référence	Débit entrée m ³ /h	Débit sortie m ³ /h	Débit de régénération m ³ /h	Point de rosée sous pression °C	Raccordement fem. Gaz BSP	Delta P en bar (à 7 bar)	Dimensions mm LxPxH	Consommation électrique W
ALC 6	5,9	5,00	0,90	-40°	G 1/4	0,01	137x237x653	47
ALC 10	9,7	8,20	1,50	-40°	G 1/4	0,02	137x237x653	47
ALC 17	17,5	14,90	2,60	-40°	G 1/4	0,08	137x237x653	47
ALC 22	22,4	19,00	3,40	-40°	G 1/4	0,11	137x237x941	47
ALC 33	33,4	28,40	5,00	-40°	G 1/4	0,26	137x237x941	47
ALC 56	56,1	47,70	8,40	-40°	G 3/4	0,07	198x362x824	47
ALC 77	77,4	65,80	11,60	-40°	G 3/4	0,11	198x362x824	47
ALC 121	120,9	102,80	18,10	-40°	G 3/4	0,32	198x362x1323	47
ALC 183	183,1	155,60	27,50	-40°	G 1 1/4	0,20	477x415x1326	64
ALC 241	241,4	205,20	36,20	-40°	G 1 1/4	0,32	477x415x1326	64

Débits exprimés pour une pression d'entrée de 7 bar - Température d'entrée : 35°C - Température ambiante : 25° selon norme ISO 7183

FACTEURS DE CORRECTION POUR DIFFÉRENTES PRESSIONS À L'ENTRÉE EN BAR

> Pression bar	4	5	6	7	8	9	10	11	12	13	14	15	16
> Coefficient débit	0,47	0,65	0,88	1,00	1,08	1,14	1,20	Contactez votre distributeur pour une sélection					

COEFFICIENT POUR DIFFÉRENTES TEMPÉRATURES D'AIR À L'ENTRÉE EN °C



> Température (°C)	+5	+30	+35	+40	+45	+50
> Coefficient débit	1,00	1,00	1,00	0,88	0,70	0,60

SECHEURS PAR ADSORPTION ALASKA

Niveau sonore faible : > 78 dB(A)	Application Laboratoire, industrie agro- alimentaire, robotique, télécommunications, laser	Filtration amont : 0,01 micron aval : 1 micron	Entretien réduit		Point de rosée - 40 °C	Tension 230 V - 50 Hz			
Sécheurs Alaska		Débit entrée m3/h	Poids kg	Consom- mation W	Dimensions LxPxH (mm)	Delta P en bar	Raccordement Femelle	REFERENCE	
		Point de rosée sous pression : -40 °C L'air utilisé par la colonne en phase de régénération représente environ 15% du débit d'entrée du sécheur. Débit de régénération (Débit entrée - Débit sortie) à considérer lors du choix du modèle de sécheur à installer. Garantie 1 an sur les composants à l'exception du dessiccant Débits exprimés pour pression d'entrée : 7 bar T° d'entrée : 35 °C T° ambiante : 25 °C selon la norme ISO 7183							
		Débit Taraudage en m3/h Gaz BSP							
		5.9	13	47	137 x 237 x 653	0.01	G 1/4	ALC M6	
		9.7	13	47	137 x 237 x 653	0.02	G 1/4	ALC M10	
		17.5	17	47	137 x 237 x 653	0.08	G 1/4	ALC M17	
		22.4	19	47	137 x 237 x 941	0.11	G 1/4	ALC M22	
		33.4	24	47	137 x 237 x 941	0.26	G 3/8	ALC M33	
		56.1	37	47	198 x 362 x 824	0.07	G 1/2	ALC M56	
		77.4	43	47	198 x 362 x 824	0.11	G 1/2	ALC M77	
		120.9	64	47	198 x 362 x 1323	0.32	G 3/4	ALC M121	
183.1	110	64	477 x 415 x 1326	0.32	G 1	ALC M183			
241.4	130	64	477 x 415 x 1326	0.32	G 1	ALC M241			

SECHEURS PAR ADSORPTION ALASKA

KITS D'ENTRETIEN

		DESIGNATION	REFERENCE
Kit de révision pour sécheurs Alaska			
		Kit de révision pour entretien annuel : - 1 indicateur d'humidité - 2 silencieux d'échappement - 2 navettes de pilotage - 2 joints	
		Pour ALC 6 - ALC 10 - ALC 17	ALC 6K12
		Pour ALC 22 - ALC 33	ALC 22K12
		Pour ALC 56 - ALC 77	ALC 56K12
		Pour ALC 121	ALC 121K12
		Pour ALC 183 - ALC 241	ALC 183K12
Kit de maintenance pour sécheurs Alaska			
		Kit de maintenance pour 18000 à 20000 heures ou 3 ans de fonctionnement : - 1 indicateur d'humidité - 2 silencieux d'échappement - 2 navettes de pilotage - 2 cartouches de dessicant - 6 joints	
		Pour ALC 6 - ALC 10	ALC 6K36
		Pour ALC 17	ALC 17K36
		Pour ALC 22	ALC 22K36
		Pour ALC 33	ALC 33K36
		Pour ALC 56	ALC 56K36
		Pour ALC 77	ALC 77K36
		Pour ALC 121	ALC 121K36
		Pour ALC 183	ALC 183K36
		Pour ALC 241	ALC 241K36

INDEX ALPHANUMÉRIQUE

INDEX ALPHANUMÉRIQUE

Référence	Page	Référence	Page	Référence	Page	Référence	Page	Référence	Page
0507	261	27102 OS6I	273	A10 0101	153	A2 1818	149	A3 38	150
0708EG	260	27102 OSH	272	A10 1212	153	A2 1838	149	A3 M5	150
0709	261	27102 PR6C	273	A10 1414	153	A2 3215	149	A30 12	154
0709E	260	27102 PR6I	273	A10 1818	153	A2 3401	149	A30 14	154
0809EG	260	27102 PRE	272	A10 3434	153	A2 3434	149	A30 18	154
0810E	260	27102 PREBP3	272	A10 3838	153	A2 3442	149	A30 34	154
0910EG	260	27102 SI6C	273	A11 01	153	A2 3812	149	A30 38	154
0911	261	27102 SI6I	273	A11 12	153	A2 3834	149	A31 1212	154
0911E	260	27102 SIL	272	A11 14	153	A2 3838	149	A31 1414	154
1011EG	260	27103	286	A11 18	153	A2 4201	149	A31 1818	154
1012E	260	27104	276	A11 34	153	A2 4242	149	A31 3434	154
1012EG	260	27104BUSE1	276	A11 38	153	A2 4942	149	A31 3838	154
101V	282	27105	276	A11 42	153	A2 4949	149	A32 1212	154
1113	261	27105BUSE1	276	A11 49	153	A2 6049	149	A32 1414	154
1113E	260	27106	276	A11 60	153	A2 6060	149	A32 1818	154
1113EG	260	27106BUSE1	276	A12 0101	154	A20 12	155	A32 3434	154
1213D	261	27113	277	A12 1212	154	A20 14	155	A32 3838	154
1214E	260	27201	282	A12 1414	154	A20 18	155	A33 01	153
1315	261	2731	261	A12 1818	154	A20 38	155	A33 12	153
1315EG	260	27F38	258	A12 3434	154	A21 12	155	A33 14	153
1415D	261	27FX	258	A12 3838	154	A21 14	155	A33 18	153
1416E	260	29FX	258	A13 0101	154	A21 18	155	A33 34	153
1517	261	30FX	258	A13 1212	154	A21 38	155	A33 38	153
1517EG	260	3134	261	A13 1414	154	A23 01T...	209	A34 1212	156
1518	261	3437	261	A13 1818	154	A23 12T...	209	A34 1414	156
1617D	261	3740	261	A13 3434	154	A23 14T...	209	A34 1818	156
1618E	260	4043	261	A13 3838	154	A23 34T...	209	A34 3838	156
1720	261	4346	261	A14 12	156	A23 38T...	209	A35 1212	151
1819D	261	7101T	282	A14 14	156	A24 12	110	A35 1212I	158
1821	261	7200T	282	A14 18	156	A24 14	110	A35 1234	151
20	258	A1 0101	149	A14 38	156	A24 18	110	A35 1234I	158
2023	261	A1 1212	149	A15 12	156	A24 34	110	A3T 01	181
20FX	258	A1 1212I	157	A15 14	156	A24 38	110	A3T 42	181
22	258	A1 1234I	158	A15 18	156	A25 12	110	A3T 49	181
2225	261	A1 1412	149	A15 38	156	A25 14	110	A3T 60	181
22FX	258	A1 1414	149	A16 3814S2	156	A25 18	110	A4 0112	150
2327	261	A1 1414I	157	A16 3814S3	156	A25 34	110	A4 0134	150
25	258	A1 14251	149	A16 3814S4	156	A25 38	110	A4 1214	150
2528	261	A1 1438	149	A16 3814S5	156	A26 14	111	A4 1218	150
25FX	258	A1 1438I	158	A16 3814S6	156	A26 18	111	A4 1238	150
25M38	258	A1 1814	149	A17 14	167	A26 38	111	A4 1418	150
27	258	A1 1814I	158	A17 38	167	A27 14	111	A4 18M5	150
27101	282	A1 1818	149	A18 12	152	A27 18	111	A4 3412	150
27102 BL10	272	A1 1818I	157	A18 14	152	A27 38	111	A4 3438	150
27102 EC6C	273	A1 1838	149	A18 18	152	A2T 0101	149	A4 3814	150
27102 EC6I	273	A1 3401	149	A18 34	152	A2T 1212	149	A4 3818	150
27102 ECR	272	A1 3412	149	A18 38	152	A2T 1414	149	A4 4201	150
27102 F18	272	A1 3434	149	A2 0101	149	A2T 1818	149	A4 4234	150
27102 MB13	272	A1 3434I	157	A2 1201	149	A2T 3434	149	A4 4901	150
27102 MB20	272	A1 3812	149	A2 1212	149	A2T 3838	149	A4 4942	150
27102 MT6C	273	A1 3812I	158	A2 1234	149	A3 01	150	A4 6001	150
27102 MT6I	273	A1 3838	149	A2 1412	149	A3 12	150	A4 6042	150
27102 MTL	272	A1 3838I	157	A2 1414	149	A3 14	150	A4 6049	150
27102 MTLBP3	272	A1 M518	149	A2 1438	149	A3 18	150	A4 7601	150
27102 OS6C	273	A1 M5M5	149	A2 1814	149	A3 34	150	A4Z 1214	150

INDEX ALPHANUMÉRIQUE

Référence	Page	Référence	Page	Référence	Page	Référence	Page	Référence	Page
A4Z 1218	150	A7 14	152	ALF 140	384	ALR CLE80	183	ALR RIM32	183
A4Z 1238	150	A7 14J	152	ALF 161	384	ALR CTCHE6380	187,204	ALR RIM40	183
A4Z 1418	150	A7 18	152	ALF 240	384	ALR CTU63	187,204	ALR RIM50	183
A4Z 3412	150	A7 18J	152	ALF 30	384	ALR EAG63	184	ALR TE20	179
A4Z 3414	150	A7 34	152	ALF 315	384	ALR EAG80	184	ALR TE25	179
A4Z 3438	150	A7 38	152	ALF 360	384	ALR ECG20	183	ALR TE32	179
A4Z 3814	150	A7 38J	152	ALF 470	384	ALR ECG25	183	ALR TE40	179
A4Z 3818	150	A7 M5	152	ALF 580	384	ALR ECG32	183	ALR TE50	179
A4Z 6042	150	A7 M5J	152	ALF 60	384	ALR ECG40	183	ALR TEA63	179
A4Z 6049	150	A8 12	152	ALF 680	384	ALR ECG50	183	ALR TEA80	179
A4Z 7660	150	A8 14	152	ALF 80	384	ALR JAB63	184	ALR TR2520	179
A5 0142	151	A8 18	152	ALF 820	384	ALR JAB80	184	ALR TR3220	179
A5 1201	151	A8 38	152	ALF L100	385	ALR JTB20	184	ALR TR3225	179
A5 1212	151	A9 0101	153	ALF L140	385	ALR JTB25	184	ALR TR4025	179
A5 1212RL	152	A9 1212	153	ALF L30	385	ALR JTB32	184	ALR TR4032	179
A5 1234	151	A9 1414	153	ALF L60	385	ALR JTB40	184	ALR TR5032	179
A5 1412	151	A9 1818	153	ALF L80	385	ALR JTB50	184	ALR TR5040	179
A5 1414	151	A9 3434	153	ALF LM100	385	ALR LM20	177	ALR TT2012	179
A5 1414RL	152	A9 3838	153	ALF LM140	385	ALR LM25	177	ALR TT2512	179
A5 1438	151	AF 15110CN	148	ALF LM30	385	ALR LMC20	177	ALR TTA6360	180
A5 1814	151	AF 15113BK	148	ALF LM60	385	ALR LMC25	177	ALR TTA8076	180
A5 1818	151	AF 15113CN	148	ALF LM80	385	ALR M2012	183	ALR TU20L3	177
A5 1818RL	152	AIRCA 10	242	ALR 4C20	178	ALR MF2012	180	ALR TU20L6	177
A5 1838	151	AIRCA 13	242	ALR 4C25	178	ALR MF2027	180	ALR TU25L3	177
A5 3401	151	AIRCA 16	242	ALR 4C32	178	ALR MF2534	180	ALR TU25L6	177
A5 3434	151	AIRCA 19	242	ALR 4C40	178	ALR MF3242	180	ALR TU32L3	177
A5 3442	151	AIRCA 25	242	ALR 4C50	178	ALR MF4049	180	ALR TU32L6	177
A5 3812	151	AIRCA 6	242	ALR 9C20	178	ALR MF5060	180	ALR TU40L3	177
A5 3834	151	AIRCA 8	242	ALR 9C25	178	ALR MFA6376	181	ALR TU40L6	177
A5 3838	151	AIRCA 8C20	242	ALR 9C32	178	ALR MM2012	180	ALR TU50L6	177
A5 3838RL	152	ALC 121K12	390	ALR 9C40	178	ALR MM2027	180	ALR TU63L6	177
A5 4249	151	ALC 121K36	390	ALR 9C50	178	ALR MM2534	180	ALR TU80L6	177
A5 M518	151	ALC 17K36	390	ALR 9CA63	178	ALR MM3242	180	ALR UN20	178
A5T 0101	151	ALC 183K12	390	ALR 9CA80	178	ALR MM4049	180	ALR UN25	178
A5T 1212	151	ALC 183K36	390	ALR B020	179	ALR MM5060	180	ALR UN32	178
A5T 3434	151	ALC 22K12	390	ALR B025	179	ALR MMA6376	180	ALR UN40	178
A5T 3838	151	ALC 22K36	390	ALR B032	179	ALR MMA8076	180	ALR UN50	178
A5T 4242	151	ALC 241K36	390	ALR B040	179	ALR MMA8090	180	ALR UNA63	178
A5Z 1212	151	ALC 33K36	390	ALR B050	179	ALR MR2520	178	ALR UNA80	178
A5Z 1412	151	ALC 56K12	390	ALR B0A63	179	ALR MR3225	178	ALR Y20	183
A5Z 1414	151	ALC 56K36	390	ALR B0A80	179	ALR MR4032	178	ALR Y25	183
A5Z 1438	151	ALC 6K12	390	ALR BP2520	177	ALR MR5040	178	ALR YP20	183
A5Z 1814	151	ALC 6K36	390	ALR BP3220	177	ALR PM2012	180	ALR YP25	183
A5Z 1818	151	ALC 77K36	390	ALR BP4020	177	ALR PM2027	180	ARP 066101	31
A5Z 3812	151	ALC M10	389	ALR BP4025	177	ALR PM2512	180	ARP 066102	31
A5Z 3834	151	ALC M121	389	ALR BP5020	177	ALR PM2527	180	ARP 066151	31
A5Z 3838	151	ALC M17	389	ALR BP5025	177	ALR PM2534	180	ARP 066152	31
A6 1412	152	ALC M183	389	ALR BP6320	177	ALR PM3234	180	ARP 066806	31
A6 1438	152	ALC M22	389	ALR BP6325	177	ALR PM3242	180	ARP 066808	31
A6 1814	152	ALC M241	389	ALR BP6332	177	ALR PM4042	180	ARP 066810	31
A6 1838	152	ALC M33	389	ALR BP8020	177	ALR PM4049	180	ASI 061101	30
A6 3812	152	ALC M56	389	ALR BP8025	177	ALR PM5049	180	ASI 061102	30
A6 M518	152	ALC M6	389	ALR BP8032	177	ALR PM5060	180	ASI 061102SW	30
A7 12	152	ALC M77	389	ALR CLE32	183	ALR RIM20	183	ASI 061103	30
A7 12J	152	ALF 100	384	ALR CLE63	183	ALR RIM25	183	ASI 061151	30

INDEX ALPHANUMÉRIQUE

Référence	Page	Référence	Page	Référence	Page	Référence	Page	Référence	Page
ASI 061152	30	AVR CI80	185,202	BR 600IS	60	CAR G04K1	293	CAR S03K3	291
ASI 061153	30	AVR EBA	187,204	BRP 066101	33	CAR G04K2	294	CAR S03K4	291
ASI 061806	30	AVR M1212	185,202	BRP 066102	33	CAR G04K3	293	CAR S03K5	291
ASI 061808	30	AVR SP14	187,203	BRP 066151	33	CAR G04K4	292	CAR S03KEN	294
ASI 061810	30	AVR SP17	187,203	BRP 066152	33	CAR G04K5	293	CO 0612	156
ASI 061813	30	AVR Y1212	185,201	BRP 066806	33	CAR G04KEN	294	CO 0814	156
ASI 062101	31	AVR Y1212P	185,201	BRP 066808	33	CAR G05	290	CO 0915	156
ASI 068101	30	AVR Y2712	185,201	BRP 066810	33	CAR G051	290	CO 1016	156
ASI 068102	30	AVR Y2712P	185,201	BSC 1000	316	CAR G052	290	COL 1238	377
ASI 068103	30	BAC 071101	64	BSC 750	316	CAR G05B05	293	CP 016	186,202
ASI 068103WF	31,182,199	BAC 071151	64	BSI 061101	32	CAR G05B08	293	CP 1420	186,202
ASI 068104WF	31,182,199	BAC 071152	64	BSI 061102	32	CAR G05B10	293	CP 38	186,202
ASI 068151	30	BAC 07CA	64	BSI 061102SW	32	CAR G05K1	293	CP 814	186,202
ASI 068152	30	BAH 1002CP	64	BSI 061103	32	CAR G05K2	294	CPF 20	185,202
ASI 068153	30	BAH 1010	64	BSI 061151	32	CAR G05K3	293	CPF 25	185,202
ASV 1	277	BAH 1010CP	64	BSI 061152	32	CAR G05K4	293	CPF 32	185,202
ASV 100	278	BAH 1015	64	BSI 061153	32	CAR G05K5	293	CPF 40	185,202
ASV 2	277	BAH 1015CP	64	BSI 061806	32	CAR G05KEN	294	CPF 50	185,202
ASV 200	278	BAH 1020	64	BSI 061808	32	CAR MDES	295	CPF 63	185,202
ASV 301	278	BAH 1020CP	64	BSI 061810	32	CAR MES	295	CPF 80	185,202
ASV 302	278	BAL 0408E	315	BSI 061813	32	CAR S02	290	CPI 081050F14	118
ASV 303	278	BAL 0410A	314	BSI 062101	33	CAR S021	290	CPI 081050F18	118
ASV 304	278	BAL 0715E	315	BSI 068101	32	CAR S022	290	CPI 081100	118
ASV 305	278	BAL 100120CP	314	BSI 068102	32	CAR S023	290	CPI 081100F14	118
ASV 306	278	BAL 100140DP	314	BSI 068103	32	CAR S02B10	292	CPI 081100F18	118
ASV 307	278	BAL 1020A	314	BSI 068103WF	33,182,199	CAR S02B16	292	CPI 081100L14	118
ASV 308	278	BAL 1225E	315	BSI 068104WF	33,182,199	CAR S02B18	292	CPI 081101	118
ASV 309	278	BAL 140180DP	314	BSI 068151	32	CAR S02B20	292	CPI 081150F14	118
AVB 101	277	BAL 180220DP	314	BSI 068152	32	CAR S02K1	292	CPI 081150F18	118
AVB 102	277	BAL 2030A	314	BSI 068153	32	CAR S02K2	294	CPI 081150L14	118
AVB 103	277	BAL 2040B	314	BSIS 1000	316	CAR S02K3	292	CPI 081160	118
AVB 104	277	BAL 220250DP	314	BSIS 750	316	CAR S02K4	292	CPI 081160ET	118
AVB 105	277	BAL 250300F	315	BTE ESW	60	CAR S02KEN	294	CPI 081160RE	118
AVB 106	277	BAL 300350F	315	BTE ISW	60	CAR S03	290	CPI 081160RO	118
AVR AFF12	184,201	BAL 350450F	315	CADENAS	166	CAR S031	290	CPI 081161	118
AVR AFM12	185,201	BAL 4060B	314	CAR DP	295	CAR S031HVLP	289	CPI 081161ET	118
AVR AFM27	185,201	BAL 4070DP	314	CAR G04	290	CAR S032	290	CPI 081161RE	118
AVR BT2512	177,194	BAL 450550F	315	CAR G041	290	CAR S032HVLP	289	CPI 081161RO	118
AVR BT3212	177,194	BAL 550650F	315	CAR G041HVLP	289	CAR S033HVLP	289	CPI 081162	118
AVR BT4012	177,194	BAL 6080B	314	CAR G042	290	CAR S034HVLP	289	CPI 081162ET	118
AVR BT4027	177,194	BAL 650750F	315	CAR G042HVLP	289	CAR S03B10HVLP	291	CPI 081162RE	118
AVR BT5012	177,194	BAL 70100DP	314	CAR G043HVLP	289	CAR S03B14HVLP	291	CPI 081162RO	118
AVR BT5027	177,194	BAL 750900F	315	CAR G044HVLP	289	CAR S03B15	291	CPI 081200F14	118
AVR BT6312	177,194	BAL 80100CP	314	CAR G04B10HVLP	292	CAR S03B17HVLP	291	CPI 081200L14	118
AVR BT6327	177,194	BAL 9001050F	315	CAR G04B14	293	CAR S03B20	291	CPI 086101	119
AVR BT6334	177,194	BAP 076151	64	CAR G04B14HVLP	292	CAR S03B20HVLP	291	CPI 086101RE	119
AVR CHE50	187,204	BAP 076152	64	CAR G04B15HVLP	292	CAR S03B23HVLP	291	CPI 086101RO	119
AVR CHE50P	187,204	BAP 07CA	64	CAR G04B17	293	CAR S03B25	291	CPI 086808	119
AVR CHERAP	187,204	BC 0927	261	CAR G04B17HVLP	292	CAR S03HVLP	289	CPI 086808RE	119
AVR CI20	185,202	BEIS 230F	316	CAR G04B20	293	CAR S03HVLPK1	291	CPI 086808RO	119
AVR CI25	185,202	BOB 110VA	377	CAR G04B20HVLP	292	CAR S03HVLPK2	294	CPI 086810	119
AVR CI32	185,202	BOB 220VA	377	CAR G04HVLP	289	CAR S03HVLPK3	291	CPI 086810CN	119
AVR CI40	185,202	BOB 24VA	377	CAR G04HVLPK1	292	CAR S03HVLPK4	291	CPI 086810CNRE	119
AVR CI50	185,202	BOB 48VA	377	CAR G04HVLPK3	292	CAR S03HVLPK5	291	CPI 086810CNRO	119
AVR CI63	185,202	BR 501IS	60	CAR G04HVLPK5	292	CAR S03K1	291	CPI 086810RE	119

INDEX ALPHANUMÉRIQUE

Référence	Page	Référence	Page	Référence	Page	Référence	Page	Référence	Page
CPI 086810RO	119	CRP 116104	50	CSM 061103	45	DEL 31514	226	DLO 1920	217
CPI 086812	119	CRP 116152	50	CSM 061151	45	DEL 32520	226	DLO 1920LS	219
CPI 086812RE	119	CRP 116153	50	CSM 061152	45	DEL BA230	226	DLO PIV	218
CPI 086812RO	119	CRP 116154	50	CSM 061153	45	DEL BA24	226	DLOI 1625LS	219,223
CPI 086813CN	119	CRP 116810	50	CSM 061806	45	DEPANNE 244	269	DLOI 1920LS	219,223
CPI 086813CNRE	119	CRP 116813	50	CSM 061808	45	DEPANNE 400	269	DLOI PIV	222
CPI 086813CNRO	119	CRP 116816	50	CSM 061810	45	DGF 0810	215	DLS 1320N	219
CPI 08BABL	118	CRP 116819	50	CSM 061813	45	DGF 0815	215	DMF 0810CSM	214
CPI 08BARG	118	CS 180L	186,202	CSM 068101	46	DGF 0815CSM	215	DMF 0810IS	214
CPI 08JNTN	119	CS 310L	186, 202	CSM 068102	46	DGF 0820	215	DMG KITHP3	220
CPI 121150L12	120	CS 420L	186,202	CSM 068103	46	DGF 0820CSM	215	DMG KITHP6	220
CPI 121150L38	120	CS 500	186,202	CSM 068151	46	DGF 1010	215	DMO 0610GR	222
CPI 121162	120	CS VIS	186,202	CSM 068152	46	DGF 1015	215	DMO 0615GR	222
CPI 121162ET	120	CS VIS2	186,202	CSM 068153	46	DGF 1310CSM	215	DMO 0810	216
CPI 121163	120	CSI 061101	26	CSM 081101	47	DGF 1310IS	215	DMO 0815	216
CPI 121163ET	120	CSI 061102	26	CSM 081102	47	DGF PIV	215	DMO 0815CSM	216
CPI 126102RE	121	CSI 061102SW	26	CSM 081102SW	47	DGO 0620GR	222	DMO 0815HP	220
CPI 126102RO	121	CSI 061103	26	CSM 081103	47	DGO 0820HP	220	DMO 0815HPI	220,223
CPI 126103	120	CSI 061151	26	CSM 081151	47	DGO 0820HPI	220,223	DMO 0820	216
CPI 126813	120	CSI 061152	26	CSM 081152	47	DGO 10150A	135,225	DMO 0820CSM	216
CPI 126813CN	121	CSI 061153	26	CSM 081153	47	DGO 1015SIC	135,225	DMO 1010	216
CPI 126813CNRE	121	CSI 061806	26	CSM 081808	47	DGO 1025	216	DMO 1015	216
CPI 126813CNRO	121	CSI 061808	26	CSM 081810	47	DGO 1315OIL	222	DMO 1015CSM	216
CPI 126813RE	121	CSI 061810	26	CSM 081813	47	DGO 1320CSM	216	DMO 1020	216
CPI 126813RO	121	CSI 061813	26	CSM 081816	47	DGO 1320IS	216	DMO 1020CSM	216
CPI 126816	120	CSI 062101	27	CSM 088102	48	DGO 1320OIL	222	DMO 1310OIL	222
CPI 126816CN	121	CSI 068101	26	CSM 088103	48	DGO 1610	216	DMO 1315IS	216
CPI 126816CNRE	121	CSI 068102	26	CSM 088104	48	DGO 1615LS	219	DMO 1610LS	219
CPI 126816CNRO	121	CSI 068103	26	CSM 088152	48	DGO NHP	221	DMO N	217
CPI 126816RE	121	CSI 068103WF	27,182,199	CSM 088153	48	DGO NHPI	221,224	DMO NHP	221
CPI 126816RO	121	CSI 068104WF	27,182,199	CSM 088154	48	DGO NI	221,224	DMO NHPI	221,224
CPI 12BABL	120	CSI 068151	26	CSM 111102	49	DGO PIV	218	DMO NI	221,224
CPI 12BARG	120	CSI 068152	26	CSM 111103	49	DGOI 1615LS	219,223	DMO PIV	218
CPI 12JNTN	121	CSI 068153	26	CSM 111104	49	DGOI PIV	222	DMOI 1610LS	219,223
CRP 066101	27,46	CSI 081101	28	CSM 111152	49	DIFLEX 10	242	DMOI PIV	222
CRP 066102	27,46	CSI 081102	28	CSM 111153	49	DIFLEX 10C25	242	DMP 0830IS	218
CRP 066151	27,46	CSI 081102SW	28	CSM 111154	49	DIFLEX 10RG	242	DMP 1025IS	218
CRP 066152	27,46	CSI 081103	28	CSM 111810	49	DIFLEX 12	242	DOLEX 15	243
CRP 066806	27,46	CSI 081151	28	CSM 111813	49	DIFLEX 12RG	242	DOLEX 19	243
CRP 066808	27,46	CSI 081152	28	CSM 111816	49	DIFLEX 13	242	DPF 0812	215
CRP 066810	27,46	CSI 081153	28	CSM 111819	49	DIFLEX 13RG	242	DPF 0812CSM	215
CRP 066813	27,46	CSI 081808	28	CSM 118103	49	DIFLEX 16	242	DPF 0812IS	215
CRP 086101	29,48	CSI 081810	28	CSM 118104	49	DIFLEX 19	242	DPF 1010	215
CRP 086102	29,48	CSI 081813	28	CSM 118153	49	DIFLEX 25	242	DPF 1010CSM	215
CRP 086103	29,48	CSI 081816	28	CSM 118154	49	DIFLEX 32	242	DPF 1010IS	215
CRP 086151	29,48	CSI 082103	29	CSS 15	168	DIFLEX 38	242	DPF SMO	215
CRP 086152	29,48	CSI 088102	28	CSS 17	168	DIFLEX 50	242	DPF SMON	215
CRP 086153	29,48	CSI 088103	28	CSS 20	168	DIFLEX 6	242	DRF 0812CSM	214
CRP 086806	29,48	CSI 088103WF	29,182,199	CSS 23	168	DIFLEX 8	242	DRF 0812IS	214
CRP 086808	29,48	CSI 088104WF	29,182,199	CSS 26	168	DIFLEX 8C25	242	DRF 0815CSM	214
CRP 086810	29,48	CSI 088152	28	CSS 29	168	DIFLEX 8RG	242	DRF 0815IS	214
CRP 086813	29,48	CSI 088153	28	CSS 32	168	DIFLEX 9	242	DRF 1010CSM	214
CRP 086816	29,48	CSM 061101	45	CSS 36	168	DLO 1330	217	DRF 1010IS	214
CRP 116102	50	CSM 061102	45	CSS 38	168	DLO 1625	217	DRF 1012IS	214
CRP 116103	50	CSM 061102SW	45	CSS 42	168	DLO 1625LS	219	DRFI 1012ESHE	215,225

INDEX ALPHANUMÉRIQUE

Référence	Page	Référence	Page	Référence	Page	Référence	Page	Référence	Page
DSF 0805CSM	214	EPG CV30	320	ERK 1IS	279	ESI 071809	20	FCAF 106	368
DSF 0805IS	214	EPG CV60	320	ERK 2	279	ESI 071809HE	22	FCAF 107	368
DSF 1003IS	214	EPG CV65	320	ERK 21	279	ESI 071810	20	FCAF 108	368
DSFI 0805ESHE	214,224	EPG KR20	319	ERK 3	279	ESI 071810HE	22	FCAF 109	368
DVO 1025	216	EPG KR30	319	ERK 3IS	280	ESI 071813	20	FCAF 110	368
EFO 3412	129	EPG KR60	320	ERK 4	248	ESI 072103	21	FCAF 111	368
EFT 3413	129	EPG KRF20	319	ERK 4IS	248	ESI 078102	20	FCAF 112	368
EFT 3415	129	EPG KRF30	319	ERK 5	248	ESI 078103	20	FCAF 113	368
EFT 3419	129	EPG KRF60	320	ERK 5IS	248	ESI 078103WF	21,181,198	FCAF 114	368
EHS 25	244	EPG KRFC20	319	ERK 6	248	ESI 078152	20	FCAF 201	368
ELP 096002	129	EPG KRFC30	319	ERP 076101	21	ESI 078153	20	FCAF 202	368
ELP 096003	129	EPG KRFC60	320	ERP 076101HE	23	ESI 111102	24	FCAF 203	368
ELP 096103	128	EPG MB20	320	ERP 076102	21	ESI 111103	24	FCAF 204	368
ELP 096104	128	EPG MB30	320	ERP 076102HE	23	ESI 111103SW	24	FCAF 205	368
ELP 096105	128	EPG MB31	320	ERP 076103	21	ESI 111104	24	FCAF 206	368
ELP 096153	128	EPG MB34	320	ERP 076151	21	ESI 111152	24	FCAF 207	368
ELP 096154	128	EPG MB60	320	ERP 076151HE	23	ESI 111153	24	FCAF 208	368
ELP 096813	128	EPG MB65	320	ERP 076152	21	ESI 111154	24	FCAF 209	368
ELP 096815	128	EPG PG	320	ERP 076152HE	23	ESI 111809	24	FCAF 210	368
ELP 096819	128	EPG PR20	319	ERP 076153	21	ESI 111810	24	FCAF 211	368
ELP 098103	129	EPG PR30	319	ERP 076806	21	ESI 111813	24	FCAF 212	368
ELP 098104	129	EPG PR60	320	ERP 076808	21	ESI 111816	24	FCAF 213	368
ELS 090103	127	EPG PT150R	320	ERP 076808HE	23	ESI 111819	24	FCAF 214	368
ELS 090104	127	EPG PT400	320	ERP 076809	21	ETANCHE 177	160	FCAF 301	368
ELS 090105	127	EPG RT14	320	ERP 076809HE	23	EXP 10	168	FCAF 302	368
ELS 090153	127	EPG SW14	320	ERP 076810	21	EXP 11	168	FCAF 303	368
ELS 090154	127	EPG TC214	320	ERP 076810HE	23	EXP 13	168	FCAF 304	368
ELS 090813	127	EPG TC414	320	ERP 076813	21	EXP 16	168	FCAF 305	368
ELS 090815	127	EPG TC614	320	ERP 116102	25	EXP 19	168	FCAF 306	368
ELS 090819	127	EPG VS30	320	ERP 116103	25	EXP 22	168	FCAF 307	368
ELS 091103	127	EPH CA220	322	ERP 116104	25	EXP 25	168	FCAF 308	368
ELS 091104	127	EPH CA60	322	ERP 116152	25	EXP 7	168	FCAF 309	368
ELS 091105	127	EPH EGR10	322	ERP 116153	25	EXP 8	168	FCAF 310	368
ELS 091153	127	EPH KR220	321	ERP 116154	25	EXP 9	168	FCAF 311	368
ELS 091154	127	EPH KR60	321	ERP 116809	25	EXP BRE	168	FCAF 312	368
ELS 091813	127	EPH KRF220	321	ERP 116810	25	EXP F1217	168	FLT 150	160
ELS 091815	127	EPH KRF60	321	ERP 116813	25	EXP F1521	168	FORCE 3	275
ELS 091819	127	EPH KRFC220	321	ERP 116816	25	EXP F2027	168	FORCE 3F14	275
ELS 092154	128	EPH KRFC60	321	ERP 116819	25	EXP F2634	168	FOU 1014	155
ELS KITBP13	129	EPH MR220	322	ESI 071101	20	EXP F3342	168	FOU 1417	155
ELS KITBP15	129	EPH MRK220	322	ESI 071101HE	22	EXP F813	168	FOU 1421	155
ELS KITBP19	129	EPH MRKF220	322	ESI 071102	20	EXP JCN	168	FOU 1721	155
ELV 12	377	EPH PR220	321	ESI 071102HE	22	EXP JNR	168	FOU 2127	155
ELV 14	377	EPH PR60	321	ESI 071102SW	20	EXP M1217	168	FOU 2734	155
ELV 14HP	377	EPH PT12	322	ESI 071103	20	EXP M1521	168	FSI 10	167
ELV 14INOX	377	EPH SP	322	ESI 071103HE	22	EXP M2027	168	FSI 13	167
ELV 14SE	378	EPH TB940	322	ESI 071151	20	EXP M2634	168	FSI 17	167
ELV 18	377	EPH TC201	322	ESI 071151HE	22	EXP M3342	168	FSI 21	167
ELV 38	377	EPH TC212	322	ESI 071152	20	EXP M813	168	HBB 0101	143
ELV 38SE	378	EPH TC512	322	ESI 071152HE	22	FAP 18	377	HBB 1212	143
ENROULEX 10	243	EPH VOL12	322	ESI 071153	20	FCAF 101	368	HBB 1234	143
ENROULEX 8	243	ERH AB65	323	ESI 071153HE	22	FCAF 102	368	HBB 1414	143
EPG CA20	320	ERH ABG65	323	ESI 071806	20	FCAF 103	368	HBB 1438	143
EPG CA60	320	ERH G90	323	ESI 071808	20	FCAF 104	368	HBB 1814	143
EPG CV20	320	ERK 1	279	ESI 071808HE	22	FCAF 105	368	HBB 1818	143

INDEX ALPHANUMÉRIQUE

Référence	Page	Référence	Page	Référence	Page	Référence	Page	Référence	Page
HBB 3401	143	HDD 181	142	HNB 25212	143	INOX 1315E	260	IRM 061101	57
HBB 3434	143	HDD 221	142	HNB 25214	143	INOX 1315EG	260	IRM 061102	57
HBB 3812	143	HDD 261	142	HNB 25238	143	INOX 1416E	260	IRM 061103	57
HBB 3838	143	HDD 301	142	HNB 25312	143	INOX 1416EG	260	IRM 061151	57
HBB 5858	143	HELICOL 1	256,280	HNB 25334	143	INOX 1517E	260	IRM 061152	57
HBC 061251	139	HELICOL 2	256,281	HNB 25338	143	INOX 1517EG	260	IRM 061153	57
HBC 066201	139	HELICOL 3	256,279	HNB 25401	143	INOX 1518	261	IRM 061314	57
HBC 101252	139	HELICOL 4	256,280	HNB 25412	143	INOX 1618E	260	IRM 061806	57
HBC 106202	139	HELICOL 6	257,281	HNB 25434	143	INOX 1618EG	260	IRM 061808	57
HBG 061101	138	HELICOL 7	257,281	HNB 25501	143	INOX 1719E	260	IRM 061810	57
HBG 066101	138	HELICOL 8	256,280	HNB 25534	143	INOX 1719EG	260	IRM 061813	57
HBG 101102	138	HELICOL 9	280	HNB 25642	143	INOX 1720	261	IRM 062101	57
HBG 106102	138	HFP 061101	139	HNB 25749	143	INOX 1820E	260	IRM 068101	58
HBG 131103	138	HFP 066101	139	HNB 25860	143	INOX 2023	261	IRM 068102	58
HBG 136103	138	HFP 131102	139	HNJ 25012	142	IRC 061101	53	IRM 068103	58
HBG 201104	138	HFP 131103	139	HNJ 250716	142	IRC 061101FA	53	IRM 068151	58
HBG 206104	138	HFP 136102	139	HNJ 25112	142	IRC 061102	53	IRM 068152	58
HBP 061A	141	HFP 136103	139	HNJ 25134	142	IRC 061102FA	53	IRM 068153	58
HBP 061G	141	HFP 201103	139	HNJ 251716	142	IRC 061103	53	IRP 066101	15,54,58
HBP 066A	141	HFP 201104	139	HNJ 251916	142	IRC 061151	53	IRP 066101AE	15,54,58
HBP 066G	141	HFP 206103	139	HNJ 25212	142	IRC 061152	53	IRP 066102	15,54,58
HBP 101A	141	HFP 206104	139	HNJ 25234	142	IRC 061153	53	IRP 066151	15,54,58
HBP 101G	141	HFP 251104	139	HNJ 252716	142	IRC 061806	53	IRP 066152	15,54,58
HBP 106A	141	HFP 251105	139	HNJ 25278	142	IRC 061806CO	53	IRP 066301	15,54,58
HBP 106G	141	HFP 256104	139	HNJ 252916	142	IRC 061806FA	53	IRP 066310	15,54,58
HBP 131A	141	HFP 256105	139	HNJ 25334	142	IRC 061808	53	IRP 066314	15,54,58
HBP 131FP	141	HGB 0101	143	HNJ 25378	142	IRC 061808CO	53	IRP 066315	15,54,58
HBP 131PP	141	HGB 1212	143	HNJ 253916	142	IRC 061808FA	53	IRP 066354	15,54,58
HBP 131VF	141	HGB 1234	143	HNJ 25434	142	IRC 061809CO	53	IRP 066806	15,54,58
HBP 131VW	141	HGB 1238	143	HOFLEX 15	243	IRC 061810	53	IRP 066806CO	15,54,58
HBP 136A	141	HGB 1414	143	HOFLEX 19	243	IRC 061810CO	53	IRP 066808	15,54,58
HBP 136FP	141	HGB 1418	143	HPA 131103	137	IRC 061810FA	53	IRP 066808CO	15,54,58
HBP 136PP	141	HGB 1438	143	HPA 131221	137	IRC 061813	53	IRP 066809CO	15,54,58
HBP 201FP	141	HGB 1814	143	HVF 131181	140	IRC 061813FA	53	IRP 066810	15,54,58
HBP 206FP	141	HGB 1818	143	HVF 136181	140	IRC 068101	54	IRP 066810CO	15,54,58
HCA 061101	137	HGB 3401	143	HVV 131181	140	IRC 068102	54	IRP 066813	15,54,58
HCA 066101	137,137	HGB 3434	143	HVV 136181	140	IRC 068103	54	IRP 086101	17,56
HCA 101102	137	HGB 3812	143	INOX 0507	261	IRC 068151	54	IRP 086102	17,56
HCA 106102	137,137	HGB 3814	143	INOX 0708EG	260	IRC 068152	54	IRP 086103	17,56
HCA 131103	137	HGB 3838	143	INOX 0709	261	IRC 068153	54	IRP 086151	17,56
HCA 131221	137	HGD 01301	142	INOX 0709E	260	IRC 081101	55	IRP 086152	17,56
HCA 136103	137,137	HGD 12181	142	INOX 0809EG	260	IRC 081101FA	56	IRP 086153	17,56
HCA 136221	137,137	HGD 12221	142	INOX 0810E	260	IRC 081102	55	IRP 086808	17,56
HCA 201104	137	HGD 12261	142	INOX 0910EG	260	IRC 081102FA	56	IRP 086810	17,56
HCA 206104	137,137	HGD 14141	142	INOX 0911	261	IRC 081103	55	IRP 086813	17,56
HCA 251105	137	HGD 14161	142	INOX 0911E	260	IRC 081151	55	IRP 086816	17,56
HCA 256105	137,137	HGD 34261	142	INOX 1011EG	260	IRC 081152	55	IRP 116102	19,42
HCG 061101	138	HGD 34301	142	INOX 1012E	260	IRC 081153	55	IRP 116103	19,42
HCG 066101	138	HGD 38161	142	INOX 1012EG	260	IRC 081808	55	IRP 116152	19,42
HCG 101102	138	HGD 38181	142	INOX 1113	261	IRC 081808FA	56	IRP 116153	19,42
HCG 106102	138	HNB 25014	143	INOX 1113E	260	IRC 081810	55	IRP 116810	19,42
HCG 201104	138	HNB 25018	143	INOX 1113EG	260	IRC 081810FA	56	IRP 116813	19,42
HCG 206104	138	HNB 25114	143	INOX 1214E	260	IRC 081813	55	IRP 116816	19,42
HDD 141	142	HNB 25118	143	INOX 1314EG	260	IRC 081813FA	56	IRP 116819	19,42
HDD 161	142	HNB 25138	143	INOX 1315	261	IRC 081816	55	ISG 111102	41

INDEX ALPHANUMÉRIQUE

Référence	Page	Référence	Page	Référence	Page	Référence	Page	Référence	Page
ISG 111103	41	ISI 111103SW	18	JFT 1807	146	JPL 1406	158	LEF 34	188,205,386
ISG 111104	41	ISI 111104	18	JFT 1808	146	JPL 1408	158	LEF 34S	188,205,386
ISG 111152	41	ISI 111152	18	JFT 3416ZS	146	JPL 1410	158	LEF 42	188,205,386
ISG 111153	41	ISI 111153	18	JFT 3419ZS	146	JPL 1804	158	LEF 49	188,205,386
ISG 111154	41	ISI 111154	18	JFT 3425ZS	146	JPL 1806	158	LEF 60	188,205,386
ISG 111810	41	ISI 111810	18	JFT 3808	146	JPL 310	159	LEM 17	188,205,386
ISG 111813	41	ISI 111813	18	JFT 3808ZS	146	JPL 34	159	LEM 17S	188,205,386
ISG 111816	41	ISI 111816	18	JFT 3809	146	JPL 36	159	LEM 21	188,205,386
ISG 111819	41	ISI 111819	18	JFT 3810	146	JPL 38	159	LEM 21S	188,205,386
ISG 118103	41	JDT 0404	148	JFT 3810ZS	146	JPL 3806	158	LEM 27	188,205,386
ISG 118104	41	JDT 0606	148	JFT 3812	146	JPL 3808	158	LEM 27S	188,205,386
ISG 118153	41	JDT 0808	148	JFT 3813ZS	146	JPL 3810	158	LEM 34	188,205,386
ISG 118154	41	JDT 0909	148	JFT 3814	146	JPL 3812	158	LEM 34S	188,205,386
ISI 061101	14	JDT 1010	148	JFT 3816	146	JPL 51404	159	LEM 42	188,205,386
ISI 061102	14	JDT 1212	148	JFT 3816ZS	146	JPL 51406	159	LEM 49	188,205,386
ISI 061102SW	14	JDT 1313	148	JFTF 1406	147	JPL 51408	159	LEM 60	188,205,386
ISI 061103	14	JDT 1616	148	JFTF 1407	147	JPL 51410	159	LHD A1620	248
ISI 061151	14	JDT 1919	148	JFTF 1408	147	JPL 51804	159	LOCKFLEX 10BL	243
ISI 061152	14	JDT 2323	148	JFTF 1409	147	JPL 51806	159	LOCKFLEX 10RG	243
ISI 061153	14	JFO 1406	148	JFTF 1806	147	JPL 51808	159	LOCKFLEX 13BL	243
ISI 061806	14	JFO 1407	148	JFTF 3810	147	JPL 53806	159	LOCKFLEX 13RG	243
ISI 061808	14	JFO 1408	148	JFTT 1406	148	JPL 53808	159	LUB 63808C	61
ISI 061810	14	JFO 1409	148	JFTT 1408	148	JPL 53810	159	LUB 83808C	61
ISI 061813	14	JFO 1410	148	JMJ 1210	147	JPL 610	159	LUBAIR 14F	61
ISI 062101	15	JFT 0119ZS	146	JMJ 1216	147	JPL 64	159	LUBAIR 6000	61
ISI 068101	14	JFT 0125ZS	146	JMJ 1406	147	JPL 66	159	LUBAIR 63806	61
ISI 068102	14	JFT 1208ZS	146	JMJ 1407	147	JPL 68	159	LUBAIR 63808	61
ISI 068103	14	JFT 1209ZS	146	JMJ 1408	147	JPL 71404	159	LUBAIR 63810	61
ISI 068103WF	15,181,198	JFT 1210ZS	146	JMJ 1806	147	JPL 71406	159	LUBAIR 73809	61
ISI 068104WF	15,181,198	JFT 1212	146	JMJ 3808	147	JPL 71408	159	LUBAIR 8000	61
ISI 068151	14	JFT 1213ZS	146	JPC 0124	147	JPL 71804	159	MA 14	110,379
ISI 068152	14	JFT 1214	146	JPC 1210	147	JPL 71806	159	MA 18	110,379
ISI 068153	14	JFT 1216	146	JPC 1213	147	JPL 73810	159	MA 38	110,379
ISI 081101	16	JFT 1216ZS	146	JPC 1217	147	JPL 910	159	MAC 061410	249
ISI 081102	16	JFT 1219	146	JPC 1219	147	JPL 94	159	MAC 083813	249
ISI 081102SW	16	JFT 1219ZS	146	JPC 1406	147	JPL 96	159	MAE 071410	249
ISI 081103	16	JFT 1404	146	JPC 1407	147	JPL 98	159	MAE 073813	249
ISI 081151	16	JFT 1406	146	JPC 1408	147	JPL X4	159	MAI 061210	249
ISI 081152	16	JFT 1406I	157	JPC 1409	147	JPL X6	159	MAI 061410	249
ISI 081153	16	JFT 1406ZS	146	JPC 1410	147	JPL Y4	159	MAI 081213	249
ISI 081808	16	JFT 1407	146	JPC 1413	147	JPLY 10	159	MAI 083813	249
ISI 081810	16	JFT 1408	146	JPC 1806	147	JPLY 6	159	MAI 111216	249
ISI 081813	16	JFT 1408I	157	JPC 1807	147	JPLY 8	159	MAI 113416	249
ISI 081816	16	JFT 1408ZS	146	JPC 1808	147	KES 0191101	64	MAL PA105	157
ISI 082103	17	JFT 1409	146	JPC 3415	147	LAM 27	188,205,386	MAL RP150	90
ISI 088102	16	JFT 1409ZS	146	JPC 3419	147	LAM 34	188,205,386	MBC 12CS	366
ISI 088103	16	JFT 1410	146	JPC 3424	147	LAM 42	188,205,386	MBC 12ES	366
ISI 088103WF	17,181,198	JFT 1410I	157	JPC 3809	147	LAM 49	188,205,386	MBC 12IS	366
ISI 088104	16	JFT 1410ZS	146	JPC 3810	147	LAM 60	188,205,386	MBCR 12CS	366
ISI 088104WF	17,181,198	JFT 1412	146	JPC 3813	147	LEF 17	188,205,386	MBCR 12ES	366
ISI 088152	16	JFT 1412I	157	JPC 3816	147	LEF 17S	188,205,386	MBCR 12IS	366
ISI 088153	16	JFT 1804	146	JPC 3819	147	LEF 21	188,205,386	MBCR 38CS	366
ISI 088154	16	JFT 1804ZS	146	JPL 1208	158	LEF 21S	188,205,386	MBCR 38ES	366
ISI 111102	18	JFT 1806	146	JPL 1212	158	LEF 27	188,205,386	MBCR 38IS	366
ISI 111103	18	JFT 1806ZS	146	JPL 1404	158	LEF 27S	188,205,386	MBP 21	385

INDEX ALPHANUMÉRIQUE

Référence	Page	Référence	Page	Référence	Page	Référence	Page	Référence	Page
MBP 27	385	MCAF 492V	369	MDA 009	372	MFM 102	363	MPD X3KIT	365
MBP 34	385	MCAF 492X	369	MDA 030	372	MFM 103	363	MPI 1	365
MBR 12CS	366	MCAF 492Z	369	MDA 058	372	MFM 104	363	MPI 2	365
MBR 12ES	366	MCAF 601V	369	MDA 145	372	MFM 105	363	MPK 1	365
MBR 12IS	366	MCAF 601X	369	MDA 220	372	MFM 106	363	MPK 2	365
MBR 38CS	366	MCAF 601Z	369	MDA 330	372	MFM 107	363	MPK 3	365
MBR 38ES	366	MCAF 602V	369	MDA 430	372	MFM 108	363	MPK 4	365
MBR 38IS	366	MCAF 602X	369	MDA 620	372	MFM 109	363	MSI 10	167
MCAF 101	370	MCAF 602Z	369	MDO 009	372	MFM 110	363	MSI 13	167
MCAF 102	370	MCAF 90V	369	MDO 017	372	MFM 111	363	MSI 17	167
MCAF 103	370	MCAF 90X	369	MDO 030	372	MFM 112	363	MSI 21	167
MCAF 104	370	MCAF 90Z	369	MDO 058	372	MFM 113	363	MT CA0440	347
MCAF 105	370	MCAF SA1	369	MDO 145	372	MFM 114	363	MT CA0640	347
MCAF 106	370	MCAF SA10	369	MDO 220	372	MHC 004	373	MT CA1040	347
MCAF 107	370	MCAF SA15	369	MDO 330	372	MHC 007	373	MT CA1640	347
MCAF 108	370	MCAF SA16	369	MDO 430	372	MHC 015	373	MT GA1365	349
MCAF 109	370	MCAF SA18	369	MDO 620	372	MHC 024	373	MT IA0650V	349
MCAF 110	370	MCAF SA2	369	MDS 009	372	MHC 035	373	MT IA1040V	349
MCAF 13V	369	MCAF SA4	369	MDS 017	372	MHC 060	373	MT IA1050V	349
MCAF 13X	369	MCAF SA6	369	MDS 030	372	MHC 090	373	MT IA1063V	349
MCAF 13Z	369	MCAF SA8	369	MDS 058	372	MHC 120	373	MT IA1663V	349
MCAF 17V	369	MCAM 101	367	MDS 145	372	MHC 150	373	MT RA0240	348
MCAF 17X	369	MCAM 102	367	MDS 220	372	MHC 240	373	MT RA0263	348
MCAF 17Z	369	MCAM 103	367	MDS 330	372	MHC 260	373	MT RA0440	348
MCAF 201	370	MCAM 104	367	MDS 430	372	MHP 004	373	MT RA0450	348
MCAF 202	370	MCAM 105	367	MDS 620	372	MHP 007	373	MT RA1023	347
MCAF 203	370	MCAM 106	367	MFB 201	363	MHP 015	373	MT RA1040	348
MCAF 204	370	MCAM 107	367	MFB 202	363	MHP 024	373	MT RA1050	348
MCAF 205	370	MCAM 108	367	MFB 203	363	MHP 035	373	MT RA1063	348
MCAF 206	370	MCAM 109	367	MFB 204	363	MHP 060	373	MT RA1640	348
MCAF 207	370	MCAM 110	367	MFB 205	363	MHP 090	373	MT RA1663	348
MCAF 208	370	MCAM 111	367	MFB 206	363	MHP 120	373	MT RA2550	348
MCAF 209	370	MCAM 201	367	MFB 207	363	MHP 150	373	MT RS0450	348
MCAF 210	370	MCAM 202	367	MFB 208	363	MHP 240	373	MT RS1050	348
MCAF 21V	369	MCAM 203	367	MFB 209	363	MHP 260	373	MT RS1250	349
MCAF 21X	369	MCAM 204	367	MFB 210	363	MHS 007	373	MT RS1650	349
MCAF 21Z	369	MCAM 205	367	MFB 211	363	MHS 015	373	MUC 0205	371
MCAF 27V	369	MCAM 206	367	MFB 212	363	MHS 024	373	MUC 0305	371
MCAF 27X	369	MCAM 207	367	MFB 213	363	MHS 035	373	MUC 0310	371
MCAF 27Z	369	MCAM 208	367	MFB 214	363	MHS 060	373	MUC 0410	371
MCAF 301	370	MCAM 209	367	MFC 301	364	MHS 090	373	MUC 0420	371
MCAF 302	370	MCAM 210	367	MFC 302	364	MHS 120	373	MUC 0520	371
MCAF 303	370	MCAM 211	367	MFC 303	364	MHS 150	373	MUC 0525	371
MCAF 304	370	MCAM 301	367	MFC 304	364	MHS 240	373	MUC 0725	371
MCAF 305	370	MCAM 302	367	MFC 305	364	MHS 260	373	MUC 0730	371
MCAF 306	370	MCAM 303	367	MFC 306	364	MPA 1	364	MUC 1030	371
MCAF 307	370	MCAM 304	367	MFC 307	364	MPA 2	364	MUC 1530	371
MCAF 308	370	MCAM 305	367	MFC 308	364	MPA 3	364	MUC 2030	371
MCAF 309	370	MCAM 306	367	MFC 309	364	MPA 4	364	MUC 3030	371
MCAF 34V	369	MCAM 307	367	MFC 310	364	MPA J1	364	MUC 3050	371
MCAF 34X	369	MCAM 308	367	MFC 311	364	MPA J2	364	MUF 0205	371
MCAF 34Z	369	MCAM 309	367	MFC 312	364	MPA J3	364	MUF 0305	371
MCAF 491V	369	MCAM 310	367	MFC 313	364	MPA J4	364	MUF 0310	371
MCAF 491X	369	MCAM 311	367	MFC 314	364	MPD	365	MUF 0410	371
MCAF 491Z	369	MCP 500	345	MFM 101	363	MPD X3	365	MUF 0420	371

INDEX ALPHANUMÉRIQUE

Référence	Page	Référence	Page	Référence	Page	Référence	Page	Référence	Page
MUF 0520	371	ODR 25011	304	PABE M1012100	241	PAGY M270425	240	PBI12 3244	265
MUF 0525	371	ODR 35023	304	PABE M101225	240	PAM 21	189,379	PBI12 3850	265
MUF 0725	371	ODR AD14	310	PABE M121425	240	PAM FLO	379	PBI12 4456	265
MUF 0730	371	ODR PF3	310	PABE M180325	240	PARD M0406100	241	PBI12 5065	265
MUF 1030	371	ODR PN127	310	PABE M2704100	241	PARD M040625	240	PBI12 5875	265
MUF 1530	371	ODR PN180	310	PABE M270425	240	PARD M0608100	241	PBI12 6885	265
MUF 2030	371	ODR PSM180	310	PABK M030525	240	PARD M060825	240	PBI12 7795	265
MUF 3030	371	OGG 35011	307	PABK M0406100	241	PARD M0810100	241	PBI12 87112	265
MUF 3050	371	OGL 26013	307	PABK M040625	240	PARD M081025	240	PBI9 1117	265
MUS 0205	371	OGL MA13	311	PABK M0608100	241	PARD M1214100	241	PBI9 1320	265
MUS 0305	371	OGT 25011	307	PABK M060825	240	PARD M2704100	241	PBI9 814	265
MUS 0310	371	OGT 36010	307	PABK M0810100	241	PARD M270425	240	PBJ 195	269
MUS 0410	371	OGT MA10	311	PABK M081025	240	PAYW M0406100	241	PBJ12 110130	266
MUS 0420	371	OLV 35024	306	PABK M0912100	241	PAYW M040625	240	PBJ12 1627	266
MUS 0520	371	OLV P150	311	PABK M091225	240	PAYW M0608100	241	PBJ12 2335	266
MUS 0525	371	OLV P180	311	PABK M1012100	241	PAYW M060825	240	PBJ12 3045	266
MUS 0725	371	OMC 15003	302	PABK M101225	240	PAYW M0810100	241	PBJ12 5070	266
MUS 0730	371	OMD 26007	303	PABK M121425	240	PAYW M081025	240	PBJ12 7090	266
MUS 1030	371	OMD 36005	302	PABK M180325	240	PAYW M2704100	241	PBJ12 90110	266
MUS 1530	371	OMD 36005C	302	PABK M2704100	241	PAYW M270425	240	PBJ9 1016	266
MUS 2030	371	OMD 45013	303	PABK M270425	240	PB 3000	269	PBJ9 1222	266
MUS 3030	371	OMD GE	310	PABK M7510100	241	PBC 1210	268	PBJ9 1627	266
MUS 3050	371	OMD GE2	310	PABK M751025	240	PBC 1212	268	PBJ9 2335	266
NSB 0617B	61	OMD SDT	310	PACR M030525	240	PBC 1215	268	PBJ9 3045	266
NSB 0617J	61	OMG 35004	302	PACR M0406100	241	PBC 1220	268	PBJ9 3250	266
NSB 0617R	61	OMG 35018	303	PACR M040625	240	PBC 1222	268	PBJ9 5070	266
NSB 0617V	61	OMN 35009	303	PACR M0608100	241	PBC 1225	268	PBJ9 7090	266
NSB 06B	61	OMV 35058	303	PACR M060825	240	PBC 126	268	PBK 09	269
NSB 06J	61	OP BD	161	PACR M0810100	241	PBC 128	268	PBK 12	269
NSB 06R	61	OP BDM	161	PACR M081025	240	PBC 1510	268	PBK 1225	269
NSB 06V	61	OP BDMR	161	PACR M0912100	241	PBC 1512	268	PBK 123	269
NSB 08N	61	OP BDR	161	PACR M091225	240	PBC 1515	268	PBK 125	269
NSB FA	61	OPA 46009	306	PACR M1012100	241	PBC 1520	268	PBK 925	269
OBD 25025	305	OPA P1506	311	PACR M101225	240	PBC 1522	268	PBK 93	269
OBD AIG	310	OPB 25008	305	PACR M121425	240	PBC 1525	268	PBK 95	269
OBM 26016C	304	OPS 35016	305	PACR M131625	240	PBC 1528	268	PBM 10	266
OBM BCR	310	OPS P150	311	PACR M2704100	241	PBC 1530	268	PBM 11	266
OBM BDE	310	ORH 25015	309	PACR M270425	240	PBC 1532	268	PBM 12	266
OBM BDP	310	ORH 45023	309	PACR M7510100	241	PBC 1535	268	PBM 13	266
OBM BL180	310	OSD 25007	309	PACR M751025	240	PBC 1538	268	PBM 14	266
OBM POI	310	OSD LAMD10	311	PAGN M0406100	241	PBC 1540	268	PBM 15	266
OBM ROB	310	OSD LAMD13	311	PAGN M040625	240	PBC 156	268	PBM 16	266
OBM RRO	310	OSD LAMD6	311	PAGN M0608100	241	PBC 158	268	PBM 17	266
OCC 15028	300	OVD 25011	308	PAGN M060825	240	PBI12 104138	265	PBM 8	266
OCC 15028C	300	OVT 26012	308	PAGN M0810100	241	PBI12 130165	265	PBM 9	266
OCC 15050	301	OVT 36013	308	PAGN M081025	240	PBI12 150180	265	PBP 1119	266
OCC 15050C	301	OVT EMV	311	PAGN M2704100	241	PBI12 1524	265	PBP 711	266
OCC 25010	299	OXP 35013	309	PAGN M270425	240	PBI12 175205	265	PBR 104111	267
OCC 25010C	299	PABE M030525	240	PAGY M0406100	241	PBI12 1928	265	PBR 111118	267
OCC 45089	301	PABE M0406100	241	PAGY M040625	240	PBI12 200231	265	PBR 118125	267
OCC 46019	300	PABE M040625	240	PAGY M0608100	241	PBI12 2232	265	PBR 125132	267
OCC 46019C	300	PABE M0608100	241	PAGY M060825	240	PBI12 226256	265	PBR 132139	267
OCG 35001	309	PABE M060825	240	PAGY M0810100	241	PBI12 251282	265	PBR 139146	267
OCQ 15011	299	PABE M0810100	241	PAGY M081025	240	PBI12 2638	265	PBR 146153	267
OCQ 35117	299	PABE M081025	240	PAGY M2704100	241	PBI12 277307	265	PBR 153160	267

INDEX ALPHANUMÉRIQUE

Référence	Page	Référence	Page	Référence	Page	Référence	Page	Référence	Page
PBR 160167	267	PBS9 1928	264	PL JET	285	PREOL 067150	124	PTC CM8	346
PBR 167174	267	PBS9 2232	264	PL JET15	286	PREOL 067151	124	PTC ES	346
PBR 1719	267	PBS9 2638	264	PL JETI	285	PREOL 091102	123	PTC IS	346
PBR 174187	267	PBS9 3244	264	PMA 200	189,380	PREOL 091102RE	123	PTE CM6	346
PBR 187200	267	PBS9 3850	264	PNE 27101	207	PREOL 091152	123	PTE CM8	346
PBR 1921	267	PBS9 4456	264	PNE 3UN32	207	PREOL 091152RE	123	PTE ES	346
PBR 200213	267	PBS9 5065	264	PNE 4CE32	206	PREOL 091810RE	123	PTE IS	346
PBR 2123	267	PBS9 814	264	PNE 9CE32	206	PREOL 091812	123	PTE LCM11	346
PBR 213226	267	PBX12 104138	265	PNE 9CT3234	207	PREOL 091812RE	123	PTE LIS	346
PBR 226239	267	PBX12 130165	265	PNE BOU32	206	PREOL 096101	124	PUBE M030525	238
PBR 2325	267	PBX12 150180	265	PNE RFM324034	207	PREOL 096102	124	PUBE M0406100	239
PBR 239252	267	PBX12 1524	265	PNE RFM324042	207	PREOL 096153	124	PUBE M040625	238
PBR 2527	267	PBX12 175205	265	PNE RFT3234	207	PREOL 096161	124	PUBE M0710100	239
PBR 2729	267	PBX12 1928	265	PNE TEE32	206	PREOL 096162	124	PUBE M071025	238
PBR 2931	267	PBX12 200231	265	PNE TET3234	207	PREOL 097101	124	PUBE M0812100	239
PBR 3134	267	PBX12 2232	265	PNE TU32	206	PREOL 097151	124	PUBE M081225	238
PBR 3437	267	PBX12 226256	265	PNE UNI32	206	PREOL 097152	124	PUBE M2504100	239
PBR 3740	267	PBX12 251282	265	PPB 01	111	PREOL 097153	124	PUBE M250425	238
PBR 4043	267	PBX12 2638	265	PPB 12	111	PREOL 121103	123	PUBE M5508100	239
PBR 4347	267	PBX12 277307	265	PPB 14	111	PREOL 121103RE	123	PUBE M550825	238
PBR 4751	267	PBX12 3244	265	PPB 18	111	PREOL 121153	123	PUBE M951425	238
PBR 5155	267	PBX12 3850	265	PPB 34	111	PREOL 121153RE	123	PUBK M030525	238
PBR 5559	267	PBX12 4456	265	PPB 38	111	PREOL 121816	123	PUBK M0406100	239
PBR 5963	267	PBX12 5065	265	PPC 12	111	PREOL 126103	124	PUBK M040625	238
PBR 6368	267	PBX12 5875	265	PPC 14	111	PREOL 126154	124	PUBK M0710100	239
PBR 6873	267	PBX12 6885	265	PPC 18	111	PREOL 126162	124	PUBK M071025	238
PBR 7379	267	PBX12 7795	265	PPC 34	111	PREOL 126163	124	PUBK M0812100	239
PBR 7985	267	PBX12 87112	265	PPC 38	111	PREOL 127152	124	PUBK M081225	238
PBR 8591	267	PBX9 1117	265	PPC M5	111	PREOL 127153	124	PUBK M111625	238
PBR 9197	267	PBX9 1320	265	PPP 01	111	PREOL 127154	124	PUBK M180325	238
PBR 97104	267	PBX9 814	265	PPP 12	111	PREOL 161104	123	PUBK M2504100	239
PBS 150	269	PEA 21	189,379	PPP 14	111	PREOL 161154	123	PUBK M250425	238
PBS12 104138	264	PF 1316	268	PPP 18	111	PREOL 161819	123	PUBK M5508100	239
PBS12 130165	264	PF 1521	268	PPP 34	111	PREOL 166104	124	PUBK M550825	238
PBS12 150180	264	PF 2023	268	PPP 38	111	PREOL 166164	124	PUBK M9514100	239
PBS12 1524	264	PF 2225	268	PPP M5	111	PREOL 166819	124	PUBK M951425	238
PBS12 175205	264	PF 2427	268	PPS 12	111	PREOL 167154	124	PUCR M0406100	239
PBS12 1928	264	PF 2731	268	PPS 14	111	PROXI 061101	59	PUCR M040625	238
PBS12 200231	264	PF 3135	268	PPS 18	111	PROXI 061102	59	PUCR M0710100	239
PBS12 2232	264	PF 3540	268	PPS 34	111	PROXI 061103	59	PUCR M071025	238
PBS12 226256	264	PF 3843	268	PPS 38	111	PROXI 061151	59	PUCR M0812100	239
PBS12 251282	264	PF 4348	268	PPS M5	111	PROXI 061152	59	PUCR M081225	238
PBS12 2638	264	PF 4550	268	PRATIC 135	269	PROXI 061153	59	PUCR M2504100	239
PBS12 277307	264	PF 4955	268	PRATIC 300	269	PROXI 061806	59	PUCR M250425	238
PBS12 3244	264	PF 5460	268	PREOL 061101	123	PROXI 061808	59	PUCR M5508100	239
PBS12 3850	264	PF 5965	268	PREOL 061101RE	123	PROXI 061810	59	PUCR M550825	238
PBS12 4456	264	PF 6470	268	PREOL 061101RO	123	PROXI 066101	59	PUCR M951425	238
PBS12 5065	264	PF 6975	268	PREOL 061151	123	PROXI 066151	59	PUGN M0406100	239
PBS12 5875	264	PF 7380	268	PREOL 061151RE	123	PROXI 066152	59	PUGN M040625	238
PBS12 6885	264	PF 7885	268	PREOL 061808	123	PROXI 066806	59	PUGN M071025	238
PBS12 7795	264	PFA 085101	161	PREOL 061808RE	123	PROXI 066808	59	PUGN M2504100	239
PBS12 87112	264	PFA 085102	161	PREOL 061808RO	123	PROXI 066810	59	PUGN M250425	238
PBS9 1117	264	PFA 085106	161	PREOL 066101	124	PT K	346	PUGN M5508100	239
PBS9 1320	264	PFA 085108	161	PREOL 066160	124	PT RL	346	PUGN M550825	238
PBS9 1524	264	PFA 085110	161	PREOL 066161	124	PTC CM6	346	PUGY M0406100	239

INDEX ALPHANUMÉRIQUE

Référence	Page	Référence	Page	Référence	Page	Référence	Page	Référence	Page
PUGY M040625	238	PUS 86	253	PVR BP6325	194	PVR TET2527	197	RB1 818	113
PUGY M071025	238	PUS 86CX	254	PVR BP6332	194	PVR TET3234	197	RB1 838	113
PUGY M2504100	239	PUS 86IS	254	PVR BRI90	200	PVR TU20	194	RB12 10	114
PUGY M250425	238	PUS 88	253	PVR CHE110	187,204	PVR TU25	194	RB12 6	114
PUGY M5508100	239	PUYW M0406100	239	PVR COB90	200	PVR TU32	194	RB12 8	114
PUGY M550825	238	PUYW M040625	238	PVR COL1000	201	PVR TU40	194	RB3 10	113
PUR 1013F	257	PUYW M071025	238	PVR COL250	201	PVR TU50	194	RB3 12	113
PUR 1013R	257	PUYW M2504100	239	PVR COL500	201	PVR TU63	194	RB3 6	113
PUR 1121F	257	PUYW M250425	238	PVR CTU110	187,204	PVR TU90	194	RB3 8	113
PUR 1238F	257	PUYW M5508100	239	PVR CTU40	187,204	PVR UNI20	195	RB5 1014	113
PUR 1238R	257	PUYW M550825	238	PVR DEC500	200	PVR UNI25	195	RB5 1038	113
PUR 813F	257	PV 80	186,203	PVR JNT90	200	PVR UNI32	195	RB5 1238	113
PUR 813R	257	PV 880	186,203	PVR KITM	201	PVR UNI40	195	RB5 614	113
PURD M0406100	239	PVR 3UL2012	197	PVR M2012	200	PVR UNI50	195	RB5 618	113
PURD M040625	238	PVR 3UL2527	197	PVR M2512	200	PVR UNI63	195	RB5 814	113
PURD M071025	238	PVR 3UL3234	197	PVR RDD3220	198	PVR UNI90	195	RB5 818	113
PURD M2504100	239	PVR 3UL4042	197	PVR RDD4025	198	PVR VFF20	200	RB5 838	113
PURD M250425	238	PVR 3UL5049	197	PVR RDD5032	198	PVR VFF25	200	RB6 10	113
PURD M5508100	239	PVR 3UL6360	197	PVR RDD6340	198	PVR VFF32	200	RB6 6	113
PURD M550825	238	PVR 3UN20	197	PVR RDD9063	198	PVR VFF40	200	RB6 8	113
PUS 114	253	PVR 3UN25	197	PVR RDS2520	198	PVR VFF50	200	RB7 1014	114
PUS 118	253	PVR 3UN32	197	PVR RDS3225	198	PVR VFF63	200	RB7 1038	114
PUS 22	253	PVR 3UN40	197	PVR RDS4032	198	PVR Y20	200	RB7 614	114
PUS 24	253	PVR 3UN50	197	PVR RDS5040	198	PVR Y25	200	RB7 618	114
PUS 42	253	PVR 3UN63	197	PVR RDS6350	198	PVR YP20	200	RB7 814	114
PUS 44	253	PVR 4CE20	195	PVR RFM162012	196	PVR YP25	200	RB9 10	114
PUS 52	253	PVR 4CE25	195	PVR RFM202512	196	R22 CT	108,239,241	RB9 12	114
PUS 52BIS	281	PVR 4CE32	195	PVR RFM253227	196	R22 TD	108	RB9 6	114
PUS 54	253	PVR 4CE40	195	PVR RFM324034	196	RAL 1010DIS	247	RB9 8	114
PUS 54BCS	281	PVR 4CE50	195	PVR RFM405042	196	RAL 1010SIRC	248	RCC ET0303	102
PUS 54BIS	281	PVR 4CE63	195	PVR RFM506349	196	RAL 10125SIB	248	RCC ET0404	102
PUS 56	253	PVR 4CE90	195	PVR RFM637560	196	RAL 1525TLS	250	RCC ET0606	102
PUS 58	253	PVR 9CE20	195	PVR RFT2012	196	RAL 810D	247	RCC LG03M3	101
PUS 610	253	PVR 9CE25	195	PVR RFT2527	196	RAL 810DIRC	247	RCC LG03M5	101
PUS 64	253	PVR 9CE32	195	PVR RFT3234	196	RAL 810DIS	247	RCC LG0400	101
PUS 64BIS	281	PVR 9CE40	195	PVR RMT2012	197	RAL 810IRC	248	RCC LG04M3	101
PUS 64IS	254	PVR 9CE50	195	PVR RMT2527	197	RAL 810VIRC	248	RCC LG04M5	101
PUS 64J	253	PVR 9CE63	195	PVR TEE20	196	RAL 8125SIB	248	RCC LG0600	101
PUS 64NR	254	PVR 9CE90	195	PVR TEE25	196	RAL 8125X	248	RCC LG06M5	101
PUS 64R	253	PVR 9CT2012	197	PVR TEE32	196	RAL 8125XIS	248	RCC MG03M3	100
PUS 64V	253	PVR 9CT2527	197	PVR TEE40	196	RAL ACM6810	248	RCC MG03M5	100
PUS 66	253	PVR BOU20	195	PVR TEE50	196	RAL ACS810	248	RCC MG0400	100
PUS 66BCS	281	PVR BOU25	195	PVR TEE63	196	RAL AIS810	248	RCC MG04M3	100
PUS 66BIS	281	PVR BOU32	195	PVR TEE90	196	RAL DCS810	247	RCC MG04M5	100
PUS 66CX	254	PVR BOU40	195	PVR TER2520	196	RAL SCSB812	248	RCC MG0600	100
PUS 66IS	254	PVR BOU50	195	PVR TER3220	196	RAL SISB10125	248	RCC MG06M5	100
PUS 66J	253	PVR BOU63	195	PVR TER3225	196	RAL SISB8125	248	RCD FG03M3	100
PUS 66NR	254	PVR BOU90	195	PVR TER4020	196	RAL VCS810	248	RCD FG03M5	100
PUS 66R	253	PVR BP2520	194	PVR TER4025	196	RAL XCS812	248	RCD FG0400	100
PUS 66V	253	PVR BP3220	194	PVR TER5020	196	RB1 1014	113	RCD FG04M3	100
PUS 68	253	PVR BP4020	194	PVR TER5025	196	RB1 1038	113	RCD FG04M5	100
PUS 68BCS	281	PVR BP4025	194	PVR TER6320	196	RB1 1238	113	RCD FG0600	100
PUS 68BIS	281	PVR BP5020	194	PVR TER6325	196	RB1 614	113	RCD FG06M5	100
PUS 815	253	PVR BP5025	194	PVR TER9040	196	RB1 618	113	RCD MG03M3	100
PUS 84	253	PVR BP6320	194	PVR TET2012	197	RB1 814	113	RCD MG03M5	100

INDEX ALPHANUMÉRIQUE

Référence	Page	Référence	Page	Référence	Page	Référence	Page	Référence	Page
RCD MG0400	99	RMC MG1002	105	RMF ET0404	108	RMU TT0606	107	RPA ET0505	89
RCD MG04M3	100	RMC MG1003	105	RMF ET0606	108	RMU TT0808	107	RPA ET0606	89
RCD MG04M5	100	RMC MG1201	105	RMF ET0808	108	RMU TT1010	107	RPA ET0808	89
RCD MG0600	99	RMC MG1202	105	RMT AG0400	106	RMU TT1212	107	RPA ET1010	89
RCD MG06M5	100	RMC MG1203	105	RMT AG0600	106	RO E10	116	RPA ET1212	89
RCM BG03M5	103	RMC MG1403	105	RMT AG0601	106	RO E12	116	RPB FG0400	77
RCM BG04M5	103	RMC MR0400	105	RMT AG0800	106	RO E4	116	RPB FG0401	77
RCM IG03M5	103	RMC MR0401	105	RMT AG0801	106	RO E6	116	RPB FG04M5	77
RCM IG04M5	103	RMC MR0600	105	RMT AG1001	106	RO E8	116	RPB FG0500	77
RCM OG03M5	103	RMC MR0601	105	RMT AG1002	106	RO 010	116	RPB FG0501	77
RCM OG04M5	103	RMC MR0800	105	RMT AG1202	106	RO 012	116	RPB FG0502	77
RCT AG03M3	102	RMC MR0801	105	RMT AG1203	106	RO 04	116	RPB FG0503	77
RCT AG03M5	102	RMC MR0802	105	RMT AR0400	106	RO 06	116	RPB FG05M5	77
RCT AG0400	102	RMC MR1001	105	RMT AR0600	106	RO 08	116	RPB FG0600	77
RCT AG04M3	102	RMC MR1002	105	RMT AR0601	106	RO1 1014	115	RPB FG0601	77
RCT AG04M5	102	RMC MR1202	105	RMT AR0800	106	RO1 1038	115	RPB FG0602	77
RCT AG0600	102	RMC MR1203	105	RMT AR0801	106	RO1 1212	115	RPB FG0603	77
RCT AG06M5	102	RMC MR1403	105	RMT AR1001	106	RO1 1238	115	RPB FG06M5	77
RCT CG03M3	101	RMC XR0400	105	RMT AR1002	106	RO1 418	115	RPB FG0800	77
RCT CG03M5	101	RMC XR0600	105	RMT AR1202	106	RO1 614	115	RPB FG0801	77
RCT CG0400	101	RMC XR0601	105	RMT AR1203	106	RO1 618	115	RPB FG0802	77
RCT CG04M3	101	RMC XR0800	105	RMT CG0400	106	RO1 814	115	RPB FG0803	77
RCT CG04M5	101	RMC XR0801	105	RMT CG0401	106	RO1 818	115	RPB FG1000	77
RCT CG0600	101	RMC XR1001	105	RMT CG0600	106	RO1 838	115	RPB FG1001	77
RCT CG06M5	101	RMD FG0400	104	RMT CG0601	106	RO3 10	115	RPB FG1002	77
RCT ET0303	103	RMD FG0600	104	RMT CG0800	106	RO3 12	115	RPB FG1003	77
RCT ET0404	103	RMD FG0601	104	RMT CG0801	106	RO3 4	115	RPB FG1201	77
RCT ET0606	103	RMD FG0800	104	RMT CG0802	106	RO3 6	115	RPB FG1202	77
RCU ET0303	102	RMD FG0801	104	RMT CG1001	106	RO3 8	115	RPB FG1203	77
RCU ET0404	102	RMD FG1001	104	RMT CG1002	106	RO5 1014	115	RPB FG1602	77
RCU ET0606	102	RMD MG0400	104	RMT CG1202	106	RO5 1038	115	RPB FG1603	77
RCU TT0303	102	RMD MG0401	104	RMT CG1203	106	RO5 1212	115	RPB MG0400	76
RCU TT0404	102	RMD MG0600	104	RMT CG1403	106	RO5 1238	115	RPB MG0401	76
RCU TT0606	102	RMD MG0601	104	RMT CR0400	106	RO5 418	115	RPB MG04M5	76
RCY ET0404	103	RMD MG0800	104	RMT CR0401	106	RO5 614	115	RPB MG0500	76
RCY ET0606	103	RMD MG0801	104	RMT CR0600	106	RO5 618	115	RPB MG0501	76
RD 17	166	RMD MG0802	104	RMT CR0601	106	RO5 814	115	RPB MG0502	76
RD 21	166	RMD MG1001	104	RMT CR0800	106	RO5 818	115	RPB MG0503	76
RD 27	166	RMD MG1002	104	RMT CR0801	106	RO5 838	115	RPB MG05M5	76
RD 34	166	RMD MG1003	104	RMT CR0802	106	RO6 10	115	RPB MG0600	76
RG DT14	110	RMD MG1201	104	RMT CR1001	106	RO6 12	115	RPB MG0601	76
RMC ET0404	107	RMD MG1202	104	RMT CR1002	106	RO6 4	115	RPB MG0602	76
RMC ET0606	107	RMD MG1203	104	RMT ET0404	107	RO6 6	115	RPB MG0603	76
RMC ET0808	107	RMD MG1402	104	RMT ET0606	107	RO6 8	115	RPB MG06M5	76
RMC ET1010	107	RMD MG1403	104	RMT ET0808	107	RO7 418	116	RPB MG0800	76
RMC ET1212	107	RMD MR0400	104	RMT ET1010	107	RO7 614	116	RPB MG0801	76
RMC ET1414	107	RMD MR0600	104	RMT ET1212	107	RO7 618	116	RPB MG0802	76
RMC MG0400	105	RMD MR0601	104	RMT ET1414	107	RO7 814	116	RPB MG0803	76
RMC MG0401	105	RMD MR0800	104	RMU ET0404	107	RO7 818	116	RPB MG1000	76
RMC MG0600	105	RMD MR0801	104	RMU ET0606	107	RO9 10	116	RPB MG1001	76
RMC MG0601	105	RMD MR0802	104	RMU ET0808	107	RO9 12	116	RPB MG1002	76
RMC MG0800	105	RMD MR1001	104	RMU ET1010	107	RO9 4	116	RPB MG1003	76
RMC MG0801	105	RMD MR1002	104	RMU ET1212	107	RO9 6	116	RPB MG1201	76
RMC MG0802	105	RMD MR1202	104	RMU ET1414	107	RO9 8	116	RPB MG1202	76
RMC MG1001	105	RMD MR1203	104	RMU TT0404	107	RPA ET0404	89	RPB MG1203	76

INDEX ALPHANUMÉRIQUE

Référence	Page	Référence	Page	Référence	Page	Référence	Page	Référence	Page
RPB MG1602	76	RPC FG1202	73	RPC LR1402	71	RPC MR1602	70	RPD MG0601	67
RPB MG1603	76	RPC FG1203	73	RPC LR1403	71	RPC MR1603	70	RPD MG0602	67
RPB MR0400	75	RPC FG1402	73	RPC LR1602	71	RPC PT0404	85	RPD MG0603	67
RPB MR0401	75	RPC FG1403	73	RPC LR1603	71	RPC PT0505	85	RPD MG06M5	68
RPB MR0500	75	RPC FG1602	73	RPC MG0400	70	RPC PT0606	85	RPD MG0800	67
RPB MR0501	75	RPC FG1603	73	RPC MG0401	70	RPC PT0808	85	RPD MG0801	67
RPB MR0502	75	RPC LG0400	72	RPC MG04M5	71	RPC PT1010	85	RPD MG0802	67
RPB MR0503	75	RPC LG0401	72	RPC MG0500	70	RPC PT1212	85	RPD MG0803	67
RPB MR0600	75	RPC LG04M5	72	RPC MG0501	70	RPC PT1414	85	RPD MG1000	67
RPB MR0601	75	RPC LG0500	72	RPC MG0502	70	RPC PT1616	85	RPD MG1001	67
RPB MR0602	75	RPC LG0501	72	RPC MG0503	70	RPC TT0404	85	RPD MG1002	67
RPB MR0603	75	RPC LG0502	72	RPC MG05M5	71	RPC TT0505	85	RPD MG1003	67
RPB MR0800	75	RPC LG0503	72	RPC MG0600	70	RPC TT0606	85	RPD MG1201	67
RPB MR0801	75	RPC LG05M5	72	RPC MG0601	70	RPC TT0808	85	RPD MG1202	67
RPB MR0802	75	RPC LG0600	72	RPC MG0602	70	RPC TT1010	85	RPD MG1203	67
RPB MR0803	75	RPC LG0601	72	RPC MG0603	70	RPC TT1212	85	RPD MG1402	67
RPB MR1000	75	RPC LG0602	72	RPC MG06M5	71	RPC TT1414	85	RPD MG1403	67
RPB MR1001	75	RPC LG0603	72	RPC MG0800	70	RPC TT1616	85	RPD MG1602	67
RPB MR1002	75	RPC LG06M5	72	RPC MG0801	70	RPD FG0400	68	RPD MG1603	67
RPB MR1003	75	RPC LG0800	72	RPC MG0802	70	RPD FG0401	68	RPD MR0400	67
RPB MR1201	75	RPC LG0801	72	RPC MG0803	70	RPD FG04M5	68	RPD MR0401	67
RPB MR1202	75	RPC LG0802	72	RPC MG1000	70	RPD FG0500	68	RPD MR0500	67
RPB MR1203	75	RPC LG0803	72	RPC MG1001	70	RPD FG0501	68	RPD MR0501	67
RPB MR1602	75	RPC LG1000	72	RPC MG1002	70	RPD FG0502	68	RPD MR0502	67
RPB MR1603	75	RPC LG1001	72	RPC MG1003	70	RPD FG0503	68	RPD MR0503	67
RPC ET0404	85	RPC LG1002	72	RPC MG1201	70	RPD FG05M5	68	RPD MR0600	67
RPC ET0505	85	RPC LG1003	72	RPC MG1202	70	RPD FG0600	68	RPD MR0601	67
RPC ET0606	85	RPC LG1201	72	RPC MG1203	70	RPD FG0601	68	RPD MR0602	67
RPC ET0808	85	RPC LG1202	72	RPC MG1402	70	RPD FG0602	68	RPD MR0603	67
RPC ET1010	85	RPC LG1203	72	RPC MG1403	70	RPD FG0603	68	RPD MR0800	67
RPC ET1212	85	RPC LG1402	72	RPC MG1602	70	RPD FG06M5	68	RPD MR0801	67
RPC ET1414	85	RPC LG1403	72	RPC MG1603	70	RPD FG0800	68	RPD MR0802	67
RPC ET1616	85	RPC LG1602	72	RPC MR0400	70	RPD FG0801	68	RPD MR0803	67
RPC FG0400	73	RPC LG1603	72	RPC MR0401	70	RPD FG0802	68	RPD MR1000	67
RPC FG0401	73	RPC LR0400	71	RPC MR0500	70	RPD FG0803	68	RPD MR1001	67
RPC FG04M5	73	RPC LR0401	71	RPC MR0501	70	RPD FG1000	68	RPD MR1002	67
RPC FG0500	73	RPC LR0500	71	RPC MR0502	70	RPD FG1001	68	RPD MR1003	67
RPC FG0501	73	RPC LR0501	71	RPC MR0503	70	RPD FG1002	68	RPD MR1201	67
RPC FG0502	73	RPC LR0502	71	RPC MR0600	70	RPD FG1003	68	RPD MR1202	67
RPC FG0503	73	RPC LR0503	71	RPC MR0601	70	RPD FG1201	68	RPD MR1203	67
RPC FG05M5	73	RPC LR0600	71	RPC MR0602	70	RPD FG1202	68	RPD MR1402	67
RPC FG0600	73	RPC LR0601	71	RPC MR0603	70	RPD FG1203	68	RPD MR1403	67
RPC FG0601	73	RPC LR0602	71	RPC MR0800	70	RPD FG1402	68	RPD MR1602	67
RPC FG0602	73	RPC LR0603	71	RPC MR0801	70	RPD FG1403	68	RPD MR1603	67
RPC FG0603	73	RPC LR0800	71	RPC MR0802	70	RPD FG1602	68	RPD TG0400	69
RPC FG06M5	73	RPC LR0801	71	RPC MR0803	70	RPD FG1603	68	RPD TG0401	69
RPC FG0800	73	RPC LR0802	71	RPC MR1000	70	RPD MG0400	67	RPD TG04M5	69
RPC FG0801	73	RPC LR0803	71	RPC MR1001	70	RPD MG0401	67	RPD TG0500	69
RPC FG0802	73	RPC LR1000	71	RPC MR1002	70	RPD MG04M5	68	RPD TG0501	69
RPC FG0803	73	RPC LR1001	71	RPC MR1003	70	RPD MG0500	67	RPD TG0502	69
RPC FG1000	73	RPC LR1002	71	RPC MR1201	70	RPD MG0501	67	RPD TG0503	69
RPC FG1001	73	RPC LR1003	71	RPC MR1202	70	RPD MG0502	67	RPD TG05M5	69
RPC FG1002	73	RPC LR1201	71	RPC MR1203	70	RPD MG0503	67	RPD TG0600	69
RPC FG1003	73	RPC LR1202	71	RPC MR1402	70	RPD MG05M5	68	RPD TG0601	69
RPC FG1201	73	RPC LR1203	71	RPC MR1403	70	RPD MG0600	67	RPD TG0602	69

INDEX ALPHANUMÉRIQUE

Référence	Page	Référence	Page	Référence	Page	Référence	Page	Référence	Page
RPD TG0603	69	RPL PG1201	98	RPM IG0601	92	RPM OR0602	93	RPQ MG0503	74
RPD TG06M5	69	RPL PG1202	98	RPM IG0602	92	RPM OR0603	93	RPQ MG05M5	75
RPD TG0800	69	RPL PG1203	98	RPM IG0603	92	RPM OR0800	93	RPQ MG0600	74
RPD TG0801	69	RPL TG0400	98	RPM IG06M5	92	RPM OR0801	93	RPQ MG0601	74
RPD TG0802	69	RPL TG0600	98	RPM IG0800	92	RPM OR0802	93	RPQ MG0602	74
RPD TG0803	69	RPL TG0601	98	RPM IG0801	92	RPM OR0803	93	RPQ MG0603	74
RPD TG1000	69	RPL TG0800	98	RPM IG0802	92	RPM OR1000	93	RPQ MG06M5	75
RPD TG1001	69	RPL TG0801	98	RPM IG0803	92	RPM OR1001	93	RPQ MG0800	74
RPD TG1002	69	RPL TG0802	98	RPM IG1000	92	RPM OR1002	93	RPQ MG0801	74
RPD TG1003	69	RPL TG1001	98	RPM IG1001	92	RPM OR1003	93	RPQ MG0802	74
RPD TG1201	69	RPL TG1002	98	RPM IG1002	92	RPM OR1201	93	RPQ MG0803	74
RPD TG1202	69	RPL TG1003	98	RPM IG1003	92	RPM OR1202	93	RPQ MG1000	74
RPD TG1203	69	RPL TG1201	98	RPM IG1201	92	RPM OR1203	93	RPQ MG1001	74
RPD TG1402	69	RPL TG1202	98	RPM IG1202	92	RPN ET0404	88	RPQ MG1002	74
RPD TG1403	69	RPL TG1203	98	RPM IG1203	92	RPN ET0505	88	RPQ MG1003	74
RPD TG1602	69	RPM BG0400	94	RPM IR0400	92	RPN ET0606	88	RPQ MG1201	74
RPD TG1603	69	RPM BG0401	94	RPM IR0401	92	RPN ET0808	88	RPQ MG1202	74
RPH PT0404	89	RPM BG04M5	94	RPM IR0600	92	RPN IT0604	88	RPQ MG1203	74
RPH PT0606	89	RPM BG0600	94	RPM IR0601	92	RPN IT0804	88	RPQ MR0400	74
RPH PT0808	89	RPM BG0601	94	RPM IR0602	92	RPN IT0806	88	RPQ MR0401	74
RPH PT1010	89	RPM BG0602	94	RPM IR0603	92	RPN IT1006	88	RPQ MR0500	74
RPH PT1212	89	RPM BG0603	94	RPM IR0800	92	RPN IT1008	88	RPQ MR0501	74
RPJ PG0400	89	RPM BG06M5	94	RPM IR0801	92	RPN KG1082	81	RPQ MR0502	74
RPJ PG04M5	89	RPM BG0800	94	RPM IR0802	92	RPN KG1083	81	RPQ MR0503	74
RPJ PG0500	89	RPM BG0801	94	RPM IR0803	92	RPN KG6400	81	RPQ MR0600	74
RPJ PG0501	89	RPM BG0802	94	RPM IR1000	92	RPN KG8401	81	RPQ MR0601	74
RPJ PG05M5	89	RPM BG0803	94	RPM IR1001	92	RPN KG8601	81	RPQ MR0602	74
RPJ PG0600	89	RPM BG1000	94	RPM IR1002	92	RPN MG0400	81	RPQ MR0603	74
RPJ PG0601	89	RPM BG1001	94	RPM IR1003	92	RPN MG0401	81	RPQ MR0800	74
RPJ PG06M5	89	RPM BG1002	94	RPM IR1201	92	RPN MG04M5	81	RPQ MR0801	74
RPJ PG0800	89	RPM BG1003	94	RPM IR1202	92	RPN MG0500	81	RPQ MR0802	74
RPJ PG0801	89	RPM BG1201	94	RPM IR1203	92	RPN MG0501	81	RPQ MR0803	74
RPJ PG0802	89	RPM BG1202	94	RPM OG0400	93	RPN MG0502	81	RPQ MR1000	74
RPJ PG1001	89	RPM BG1203	94	RPM OG0401	93	RPN MG0503	81	RPQ MR1001	74
RPJ PG1002	89	RPM BR0400	94	RPM OG04M5	93	RPN MG05M5	81	RPQ MR1002	74
RPJ PG1201	89	RPM BR0401	94	RPM OG0600	93	RPN MG0600	81	RPQ MR1003	74
RPJ PG1202	89	RPM BR0600	94	RPM OG0601	93	RPN MG0601	81	RPQ MR1201	74
RPL DG0000	98	RPM BR0601	94	RPM OG0602	93	RPN MG0602	81	RPQ MR1202	74
RPL DG0101	98	RPM BR0602	94	RPM OG0603	93	RPN MG0603	81	RPQ MR1203	74
RPL DG0202	98	RPM BR0603	94	RPM OG06M5	93	RPN MG06M5	81	RPQ PT0404	85
RPL DG0303	98	RPM BR0800	94	RPM OG0800	93	RPN MG0800	81	RPQ PT0505	85
RPL ET0404	99	RPM BR0801	94	RPM OG0801	93	RPN MG0801	81	RPQ PT0606	85
RPL ET0606	99	RPM BR0802	94	RPM OG0802	93	RPN MG0802	81	RPQ PT0808	85
RPL ET0808	99	RPM BR0803	94	RPM OG0803	93	RPN MG0803	81	RPQ PT1010	85
RPL ET1010	99	RPM BR1000	94	RPM OG1000	93	RPO ET0404	99	RPQ PT1212	85
RPL ET1212	99	RPM BR1001	94	RPM OG1001	93	RPO ET0606	99	RPR PT0504	84
RPL PG0400	98	RPM BR1002	94	RPM OG1002	93	RPO ET0808	99	RPR PT0604	84
RPL PG0600	98	RPM BR1003	94	RPM OG1003	93	RPO ET1010	99	RPR PT0804	84
RPL PG0601	98	RPM BR1201	94	RPM OG1201	93	RPO ET1212	99	RPR PT0806	84
RPL PG0800	98	RPM BR1202	94	RPM OG1202	93	RPQ MG0400	74	RPR PT1006	84
RPL PG0801	98	RPM BR1203	94	RPM OG1203	93	RPQ MG0401	74	RPR PT1008	84
RPL PG0802	98	RPM IG0400	92	RPM OR0400	93	RPQ MG04M5	75	RPR PT1208	84
RPL PG1001	98	RPM IG0401	92	RPM OR0401	93	RPQ MG0500	74	RPR PT1210	84
RPL PG1002	98	RPM IG04M5	92	RPM OR0600	93	RPQ MG0501	74	RPS DG0000	91
RPL PG1003	98	RPM IG0600	92	RPM OR0601	93	RPQ MG0502	74	RPS DG0100	91

INDEX ALPHANUMÉRIQUE

Référence	Page	Référence	Page	Référence	Page	Référence	Page	Référence	Page
RPS DG0101	91	RPT AG1003	80	RPT CG1202	78	RPU ET1414	83	RPV IG0602	95
RPS DG0201	91	RPT AG1201	80	RPT CG1203	78	RPU ET1616	83	RPV IG0603	95
RPS DG0202	91	RPT AG1202	80	RPT CG1402	78	RPU IT0604	84	RPV IG06M5	95
RPS DG0302	91	RPT AG1203	80	RPT CG1403	78	RPU IT0806	84	RPV IG0800	95
RPS DG0303	91	RPT AG1402	80	RPT CG1602	78	RPU IT1008	84	RPV IG0801	95
RPS ET0606	91	RPT AG1403	80	RPT CG1603	78	RPU IT1210	84	RPV IG0802	95
RPS ET0808	91	RPT AG1602	80	RPT CR0400	78	RPU IT1612	84	RPV IG0803	95
RPS ET1010	91	RPT AG1603	80	RPT CR0401	78	RPU TT0404	84	RPV IG1000	95
RPS ET1212	91	RPT AR0400	79	RPT CR0500	78	RPU TT0505	84	RPV IG1001	95
RPS IT0806	91	RPT AR0401	79	RPT CR0501	78	RPU TT0606	84	RPV IG1002	95
RPS IT1210	91	RPT AR0500	79	RPT CR0502	78	RPU TT0808	84	RPV IG1003	95
RPS PG0600	90	RPT AR0501	79	RPT CR0503	78	RPU TT1010	84	RPV IG1201	95
RPS PG0601	90	RPT AR0502	79	RPT CR0600	78	RPU TT1212	84	RPV IG1202	95
RPS PG0602	90	RPT AR0503	79	RPT CR0601	78	RPU TT1616	84	RPV IG1203	95
RPS PG0800	90	RPT AR0600	79	RPT CR0602	78	RPV BG0400	97	RPV IR0400	95
RPS PG0801	90	RPT AR0601	79	RPT CR0603	78	RPV BG0401	97	RPV IR0401	95
RPS PG0802	90	RPT AR0602	79	RPT CR0800	78	RPV BG04M5	97	RPV IR0600	95
RPS PG1001	90	RPT AR0603	79	RPT CR0801	78	RPV BG0600	97	RPV IR0601	95
RPS PG1002	90	RPT AR0800	79	RPT CR0802	78	RPV BG0601	97	RPV IR0602	95
RPS PG1003	90	RPT AR0801	79	RPT CR0803	78	RPV BG0602	97	RPV IR0603	95
RPS PG1201	90	RPT AR0802	79	RPT CR1000	78	RPV BG0603	97	RPV IR0800	95
RPS PG1202	90	RPT AR0803	79	RPT CR1001	78	RPV BG06M5	97	RPV IR0801	95
RPS PG1203	90	RPT AR1000	79	RPT CR1002	78	RPV BG0800	97	RPV IR0802	95
RPS TG0600	90	RPT AR1001	79	RPT CR1003	78	RPV BG0801	97	RPV IR0803	95
RPS TG0601	90	RPT AR1002	79	RPT CR1201	78	RPV BG0802	97	RPV IR1000	95
RPS TG0602	90	RPT AR1003	79	RPT CR1202	78	RPV BG0803	97	RPV IR1001	95
RPS TG0800	90	RPT AR1201	79	RPT CR1203	78	RPV BG1000	97	RPV IR1002	95
RPS TG0801	90	RPT AR1202	79	RPT CR1402	78	RPV BG1001	97	RPV IR1003	95
RPS TG0802	90	RPT AR1203	79	RPT CR1403	78	RPV BG1002	97	RPV IR1201	95
RPS TG1001	90	RPT AR1402	79	RPT CR1602	78	RPV BG1003	97	RPV IR1202	95
RPS TG1002	90	RPT AR1403	79	RPT CR1603	78	RPV BG1201	97	RPV IR1203	95
RPS TG1003	90	RPT AR1602	79	RPT ET0404	87	RPV BG1202	97	RPV OG0400	96
RPS TG1201	90	RPT AR1603	79	RPT ET0505	87	RPV BG1203	97	RPV OG0401	96
RPS TG1202	90	RPT CG0400	78	RPT ET0606	87	RPV BR0400	97	RPV OG04M5	96
RPS TG1203	90	RPT CG0401	78	RPT ET0808	87	RPV BR0401	97	RPV OG0600	96
RPT AG0400	80	RPT CG04M5	79	RPT ET1010	87	RPV BR0600	97	RPV OG0601	96
RPT AG0401	80	RPT CG0500	78	RPT ET1212	87	RPV BR0601	97	RPV OG0602	96
RPT AG04M5	80	RPT CG0501	78	RPT ET1414	87	RPV BR0602	97	RPV OG0603	96
RPT AG0500	80	RPT CG0502	78	RPT ET1616	87	RPV BR0603	97	RPV OG06M5	96
RPT AG0501	80	RPT CG0503	78	RPT IT0604	87	RPV BR0800	97	RPV OG0800	96
RPT AG0502	80	RPT CG05M5	79	RPT IT0806	87	RPV BR0801	97	RPV OG0801	96
RPT AG0503	80	RPT CG0600	78	RPT IT1008	87	RPV BR0802	97	RPV OG0802	96
RPT AG05M5	80	RPT CG0601	78	RPT IT1210	87	RPV BR0803	97	RPV OG0803	96
RPT AG0600	80	RPT CG0602	78	RPT IT1612	87	RPV BR1000	97	RPV OG1000	96
RPT AG0601	80	RPT CG0603	78	RPT JT0604	87	RPV BR1001	97	RPV OG1001	96
RPT AG0602	80	RPT CG06M5	79	RPT JT0806	87	RPV BR1002	97	RPV OG1002	96
RPT AG0603	80	RPT CG0800	78	RPT JT1008	87	RPV BR1003	97	RPV OG1003	96
RPT AG06M5	80	RPT CG0801	78	RPT JT1210	87	RPV BR1201	97	RPV OG1201	96
RPT AG0800	80	RPT CG0802	78	RPT JT1612	87	RPV BR1202	97	RPV OG1202	96
RPT AG0801	80	RPT CG0803	78	RPU ET0404	83	RPV BR1203	97	RPV OG1203	96
RPT AG0802	80	RPT CG1000	78	RPU ET0505	83	RPV IG0400	95	RPV OR0400	96
RPT AG0803	80	RPT CG1001	78	RPU ET0606	83	RPV IG0401	95	RPV OR0401	96
RPT AG1000	80	RPT CG1002	78	RPU ET0808	83	RPV IG04M5	95	RPV OR0600	96
RPT AG1001	80	RPT CG1003	78	RPU ET1010	83	RPV IG0600	95	RPV OR0601	96
RPT AG1002	80	RPT CG1201	78	RPU ET1212	83	RPV IG0601	95	RPV OR0602	96

INDEX ALPHANUMÉRIQUE

Référence	Page	Référence	Page	Référence	Page	Référence	Page	Référence	Page
RPV OR0603	96	RPY MG1402	82	RSIM 27	165	RX7 814	109	SPH 210	380
RPV OR0800	96	RPY MG1403	82	RSIM 27PAP	165	RX7 818	109	SPH 2100	380
RPV OR0801	96	RPY MG1602	82	RSIM 34	165	RX7 838	109	SPH 2100CAFB	381
RPV OR0802	96	RPY MG1603	82	RSIMF 13	165	RX9 4	109	SPH 2100CAFW	381
RPV OR0803	96	RPY MR0400	82	RSIMF 17	165	RX9 6	109	SPH 210CAFB	381
RPV OR1000	96	RPY MR0401	82	RSIMF 21	165	RX9 8	109	SPH 210CAFW	381
RPV OR1001	96	RPY MR0500	82	RSIMF 27	165	SDA 6I	276	SPH 480	380
RPV OR1002	96	RPY MR0501	82	RSIMF 34	165	SDA 7E	276	SPH 480CAFB	381
RPV OR1003	96	RPY MR0502	82	RST ACS810	247	SER 02	261	SPH 480CAFW	381
RPV OR1201	96	RPY MR0503	82	RST ACSW1010	249	SER 04	261	SPH EXT	380
RPV OR1202	96	RPY MR0600	82	RST AIRC810	247	SIC 061102S3	134	SPH EXTCAFB	381
RPV OR1203	96	RPY MR0601	82	RST AIRM810	247	SIC 061316S3	134	SPI 1	258,315
RPX ET0404	88	RPY MR0602	82	RST AIS1010	247	SIC 061806K	134	SPI 3	258,315
RPX ET0505	88	RPY MR0603	82	RST AIS1310	247	SIC 061806S2K	134	SPI 5	258,315
RPX ET0606	88	RPY MR0800	82	RST AIS81010	247	SIC 061810K	134	SPI 7	258,315
RPX ET0808	88	RPY MR0801	82	RST AISCW1010	249	SIC 061810S2K	134	SPI 95	255
RPX ET1010	88	RPY MR0802	82	RST AISCW810	249	SIC 066806K	134	SPIC 1016	255
RPX ET1212	88	RPY MR0803	82	RST AISCW81310	249	SIC 066810K	134	SPIC 102	255
RPY ET0404	86	RPY MR1000	82	RST SCSB810	247	SIC 069806806K	134	SPIC 104	255
RPY ET0505	86	RPY MR1001	82	RST SERCB1010	247	SIC 069810806K	134	SPIC 108	255
RPY ET0606	86	RPY MR1002	82	RST SERCB810	247	SIC 069810810K	134	SPIC 610	255
RPY ET0808	86	RPY MR1003	82	RST SERCB910	247	SIJ 061806K	133	SPIC 610FX	255
RPY ET1010	86	RPY MR1201	82	RST SESB1010	247	SIJ 061810K	133	SPIC 62	255
RPY ET1212	86	RPY MR1202	82	RST SESB1012	247	SIJ 066806K	134	SPIC 620	255
RPY ET1414	86	RPY MR1203	82	RST SESB810	247	SIJ 066806S2K	133	SPIC 620FX	255
RPY ET1616	86	RPY MR1402	82	RST SESB910	247	SIJ 066810K	134	SPIC 65	255
RPY IT0604	86	RPY MR1403	82	RST SESW1010	249	SIJ 066810S2K	133	SPIC 65FX	255
RPY IT0806	86	RPY MR1602	82	RST SESW1012	249	SIK 0606	132	SPIC 810	255
RPY IT1008	86	RPY MR1603	82	RST SESW810	249	SIK 0606DR	133	SPIC 810FX	255
RPY IT1210	86	RPY PT0404	86	RST SESW910	249	SIK 0606DS	133	SPIC 82	255
RPY IT1612	86	RPY PT0505	86	RST SIRCB1010	247	SIK 0606MR	133	SPIC 820	255
RPY MG0400	82	RPY PT0604	86	RST SIRCB810	247	SIK 1006	132	SPIC 820FX	255
RPY MG0401	82	RPY PT0606	86	RST SIRCW1010	249	SIK 1006DR	133	SPIC 85	255
RPY MG04M5	83	RPY PT0806	86	RST SIRCW810	249	SIK 1006DS	133	SPIC 85FX	255
RPY MG0500	82	RPY PT0808	86	RST SISB810	247	SIK 1006MR	133	SPIR 1016	255
RPY MG0501	82	RPY PT1008	86	RST SISB912	247	SIK 1010	132	SPIR 12730	255
RPY MG0502	82	RPY PT1010	86	RST SISW810	249	SIK 1010DR	133	SPIR 1630	255
RPY MG0503	82	RPY PT1210	86	RX1 418	109	SIK 1010DS	133	SPIR 2710	255
RPY MG05M5	83	RPY PT1212	86	RX1 614	109	SIK 1010MR	133	SPIR 4526	255
RPY MG0600	82	RPY PT1414	86	RX1 618	109	SIK 10316S3	132	SPIR 456	255
RPY MG0601	82	RPY PT1616	86	RX1 814	109	SIM 06	135,250	SPIR 610	255
RPY MG0602	82	RSI 13	165	RX1 818	109	SIM 0612	135,250	SPIR 620	255
RPY MG0603	82	RSI 17	165	RX1 838	109	SIM 10	135,250	SPIR 820	255
RPY MG06M5	83	RSI 21	165	RX5 418	109	SIR 06S2	135,250	STE	275
RPY MG0800	82	RSI 27	165	RX5 614	109	SIR 10S2	135,250	STI	275
RPY MG0801	82	RSI 34	165	RX5 618	109	SPC 1101	378	STL 101	275
RPY MG0802	82	RSI 42	165	RX5 814	109	SPC 120	378	STL 151	275
RPY MG0803	82	RSI 49	165	RX5 818	109	SPC 210	378	STL 152	275
RPY MG1000	82	RSI 60	165	RX5 838	109	SPC 320	378	STL 153	275
RPY MG1001	82	RSI 76	165	RX6 4	109	SPC 450	378	STOFLEX 10	243
RPY MG1002	82	RSI 90	165	RX6 6	109	SPC 750	378	STOFLEX 8	243
RPY MG1003	82	RSIM 13	165	RX6 8	109	SPC D1275	378	STOFLEX 9	243
RPY MG1201	82	RSIM 17	165	RX7 418	109	SPC K120	378	SURFLEX 10	242
RPY MG1202	82	RSIM 21	165	RX7 614	109	SPC K210	378	SURFLEX 10C30	242
RPY MG1203	82	RSIM 21PAP	165	RX7 618	109	SPC K450	378	SURFLEX 13	242

INDEX ALPHANUMÉRIQUE

Référence	Page	Référence	Page	Référence	Page	Référence	Page	Référence	Page
SURFLEX 13C30	242	TEMP 38220COLSE	376	TR 0	329	URP 066201	35	VCA 34	166
SURFLEX 6	242	TEMP 38220KIT	189,376	TR 1	329	URP 066202	35	VDA 13	165
SURFLEX 6C30	242	TEMP 38220SE	376	TR 2	334	URP 066203	35	VDA 17	165
SURFLEX 8	242	TEMP 38220V	376	TR 3	339	URP 066251	35	VDA 21	165
SURFLEX 8C30	242	TEMP MN220V	377	TR 4	343	URP 066252	35	VDA 27	165
SURFLEX 9	242	TEMP SE	378	TR 5	343	URP 066253	35	VDA 34	165
SURFLEX 9C30	242	TF 0	329	TR B21	329	URP 066806	35	VIC 13	166
TA M1	330	TF 1	329	TR B23	339	URP 066810	35	VIC 17	166
TA M2	335	TF 105	329	TR B41	329	URP 086201	37	VIC 21	166
TA M3	340	TF 2	334	TR B43	339	URP 086202	37	VIC 27	166
TA M45	344	TF 205	334	TR E1	330	URP 086203	37	VIC 34	166
TA S1	330	TF 3	339	TR E2	335	URP 086251	37	VICA 13	166
TA S2	335	TF 305	339	TR E3	340	URP 086252	37	VICA 17	166
TA S3	340	TF 4	343	TR M1	328	URP 086253	37	VICA 21	166
TA S45	344	TF 5	343	TR M2	333	URP 086806	37	VICA 27	166
TB CSM1	328	TF C1	330	TR M3	338	URP 086810	37	VICA 34	166
TB CSM3	338	TF C101	330	TR Q1	330	URP 086813	37	VPS 34	167
TB PSM1	327	TF C105	330	TR Q2	335	USI 061201	34	Y12	155
TB PSM2	332	TF C2	335	TR Q3	340	USI 061202	34	Y12M	155
TB PSM3	337	TF C205	335	TR Q45	344	USI 061202SW	34	Y14	155
TB SM0	327	TF C3	340	TT PSM1	327	USI 061203	34	Y14M	155
TB SM1	327	TF C301	340	TT PSM2	332	USI 061251	34	Y18	155
TB SM2	332	TF C305	340	TT PSM3	337	USI 061252	34	Y18M	155
TB SM3	337	TF C45	344	TT PSM4	343	USI 061253	34	Y34	155
TB SME1	328	TF M8100	187,203	TT PSM5	343	USI 061808	34	Y38	155
TB SME2	333	TL 0	329	TT SM0	327	USI 061810	34	Y38M	155
TB SME3	337	TL 1	329	TT SM1	327	USI 068203WF	34,182,199		
TC 1	329	TL 2	334	TT SM2	332	USI 068204WF	34,182,199		
TC 3	339	TL 3	339	TT SM3	337	USI 081201	36		
TC P1	330	TL 4	343	TT SM4	343	USI 081202	36		
TC P2	335	TL 5	343	TT SM5	343	USI 081202SW	36		
TC P3	340	TL A3	339	TTF 850	186,203	USI 081203	36		
TC P34	340	TL M8	186,203	TTF 880	186,203	USI 081251	36		
TC P4	344	TL RM8	187,203	TUB OA10	244	USI 081252	36		
TC P5	344	TM 0	329	TUB OA6	244	USI 081253	36		
TC S1	330	TM 1	329	TUB OX10	244	USI 081813	36		
TC S2	335	TM 105	329	TUB OX6	244	USI 088203WF	36,182,199		
TC S3	340	TM 2	334	TUB SET10	244	USI 088204WF	36,182,199		
TC S34	340	TM 3	339	TUB SET6	244	USI 111202	38		
TD F1	330	TM 305	339	TVB 660	186,203	USI 111203	38		
TD F2	335	TM A305	339	TVB 690	186,203	USI 111204	38		
TD F3	340,344	TM D2	334	TVM 860	186,203	USI 111252	38		
TE 1	329	TM D3	339	TX CAFG1	345	USI 111253	38		
TE 2	334	TM PSM1	328	TX CAFG2	345	USI 111254	38		
TE 3	339	TM PSM2	333	TX F42	345	USI 111810	38		
TE M8	187,203	TM PSM3	338	TX F49	345	USI 111813	38		
TEFLON 12	160	TM SM0	328	TX F60	345	USI 111819	38		
TEMP	377	TM SM1	328	TX F76	345	VALYFLEX 10	243		
TEMP 12220V	376	TM SM2	333	TX L42	345	VALYFLEX 13	243		
TEMP 14220HP	377	TM SM3	338	TX L49	345	VALYFLEX 8	243		
TEMP 14220INOX	377	TP F45	330,335,340	TX L60	345	VAS 2442	311,347		
TEMP 14220SE	376	TP Q1	330	TX RG42	345	VCA 13	166		
TEMP 14220V	376	TP Q2	335	TX RG49	345	VCA 17	166		
TEMP 18220V	376	TP Q3	340	TX RG60	345	VCA 21	166		
TEMP 38220COL	376	TP Q45	344	TX RG76	345	VCA 27	166		